

EXHIBIT "A"

MASTER LEASE

**Lease between the City of Philadelphia
&**

Philadelphia Municipal Authority

EXHIBIT "A" DOCUMENTS

- 1. MASTER LEASE (Philadelphia Municipal Authority and Philadelphia Biosolids Services, LLC)**
- 2. MASTER LEASE EXHIBITS**
 - (A) DEMISED PREMISES TRANSITION AND INTERIM PERIOD TERM**
 - (B) DEMISED PREMISES CLASS A PERIOD TERM**
 - (C) ROLLING STOCK TO BE LEASED AS FIXTURES**
 - (D) SERVICE CONTRACT (City of Philadelphia & Philadelphia Municipal Authority)**
 - (1) APPENDICIES 1-15**
 - (2) SERVICE AGREEMENT (Philadelphia Municipal Authority & Philadelphia Biosolids Services, LLC, as provided in Exhibit "B")**
 - (3) SERVICES CONTRACT TRANSACTION DOCUMENTS**
 - MASTER LEASE (City and the Philadelphia Municipal Authority)**
 - LEASE (Philadelphia Municipal Authority and Philadelphia Biosolids Services, LLC as provided in Exhibit "B" of this Ordinance)**
 - GUARANTY (from SYNAGRO TECHNOLOGIES, INC.)**
 - PERFORMANCE BOND FORM**
 - PAYMENT BOND FORM**

MASTER LEASE AGREEMENT

THIS MASTER LEASE AGREEMENT (this "Lease") is dated as of the _____ day of _____, 2006, by and between **THE CITY OF PHILADELPHIA** (the "Landlord"), and **THE PHILADELPHIA MUNICIPAL AUTHORITY**, a body corporate and politic organized and existing under the laws of the Commonwealth of Pennsylvania (the "Tenant").

WITNESSETH:

WHEREAS, Landlord is a municipal corporation and a body corporate and politic organized under the laws of the Commonwealth of Pennsylvania having adopted the Philadelphia Home Rule Charter under the provisions of the First Class City Home Rule Act of April 21, 1949, P.L. 665; and

WHEREAS, the Landlord acting by and through its Water Department, owns and operates the Biosolids Recycling Center (the "BRC") at certain property owned by the City and located at 7800 Penrose Ferry Road in the City of Philadelphia, Pennsylvania ("Demised Premises") (hereinafter defined) as more particularly described in Exhibit "A" attached hereto and made a part hereof; and

WHEREAS, the Landlord and the Tenant have entered into a Service Contract for the modification and operation of the BRC (the "Service Contract") attached hereto and made part hereof as Exhibit "D, and

WHEREAS, Tenant and Philadelphia Biosolids Services, LLC ("Company") have entered into a service agreement with PMA for the modification and operation of the BRC, and a lease with PMA which is required for Company to perform under its service agreement, both of which service agreement and leases are entered this same date, pursuant to which Company, acting a a subcontractor and subtenant to PMA shall perform certain obligations required of PMA hereunder, and shall receive certain performance from PMA.

WHEREAS, the Council of the City of Philadelphia enacted an ordinance approved by the Mayor on _____, 2006 (the "Ordinance") duly empowering the Landlord to undertake a project to develop and use the Demised Premises for the modification and operation of the BRC as fully set forth in the Service Contract; and

WHEREAS, Tenant is a body corporate and politic, organized under the provisions of the Pennsylvania Municipality Authorities Act of 1945 (the Act of May 2, 1945, P.L. 382, as amended) pursuant to ordinances of the Council of the City of Philadelphia, and has requested to lease from the Landlord the Demised Premises for the modification and operation of the BRC as fully set forth in the Service Contract; and

City-PMA Lease

WHEREAS, the Landlord is willing to grant said Lease upon the promises herein set forth.

NOW, THEREFORE, for good and valuable consideration, receipt of which is hereby acknowledged, and intending to be legally bound hereby, the parties hereto agree as follows:

1. **DEFINITIONS.** The following terms are defined in the Sections of this Lease as follows:

<u>Term</u>	<u>Section</u>
Class A Period Term	3.B.
Class A Period Term Commencement Date	3.B.(iii)
Class A Period Term Lease Year	3.B.(i)
Compliance Report	21.F.
DOT	24.B.(i)
Demised Premises	2.A.
Environmental Damages	21.D.
Environmental Law	21.A.(ii)
Estoppel Certificate	18.
Final Transition and Interim Period Term Lease Year	3.A.(i)
Hazardous Substance	21.A.(i)
Transition and Interim Period Term	3.A.
Transition and Interim Period Term Lease Year	3.A.(i)
Landlord's Risk Manager	11.C.(i)
Land	2.A.
MacBride Principles	31.A.
Permitted Use	2.C.
Person	32.G.
Plans and Specifications	16.A.(iii)
Prime Rate	13.D.
Rent	4.
Restricted Activities	21.B.(i)
Secured Party	14.A.
Signs	22.
Taxes	5.A.
Tenant's Improvements	19.B.
Term	3.
Termination Date	3.C.

2. **DEMISED PREMISES.**

A. **Definition of Demised Premises.** Landlord, subject to the terms and conditions hereof, hereby leases to Tenant and Tenant hereby leases from Landlord certain land (collectively, the "Land") as more fully described in Exhibit "A" (the

City-PMA Lease

“Transition and Interim Period Term Area”) and Exhibit “B” (the “Class A Period Term Area”) attached hereto and made a part hereof under and subject to matters of record, zoning and applicable law relative to the locations of improvements on the Land and the use and operation of such improvements and any condition which a current and accurate land survey may disclose. The Land, together with any buildings, fixtures (including the rolling stock listed in Exhibit “C”) and improvements existing thereon as of the effective date hereof and hereinafter located thereon are referred to collectively as the “Demised Premises.”

B. **"AS IS" Condition.** Tenant represents and warrants to Landlord that Tenant is familiar with the Demised Premises and, except as expressly set forth herein or in the Service Contract, that they have been leased to Tenant in an "AS IS" and "WHERE IS" condition, without any representation or warranty, express or implied, including without limitation any warranty of fitness for purpose providing however that Landlord warrants that it does not know of any violations of federal, state or local environmental laws, rules or regulations concerning the Land.

C. **Permitted Use.** In accordance with the provisions of this Lease, the Demised Premises shall be used for the purposes of the construction and operation of Biosolids processing facilities and related functions as fully set forth in the Service Contract (the “Permitted Use”) and for no other purpose.

3. **TERM.** Tenant shall use and occupy the Demised Premises for the “Term.” For purposes of this Lease, the “Term” shall consist of the Transition and Interim Periods and the Class A Period as such are defined in the Service Contract. Notwithstanding anything in this Lease to the contrary, the Term of this Lease shall be exactly coterminous with the “Term” of the Service Contract as such term is defined therein and the Term of this Lease shall commence and expire (whether upon the natural expiration or early termination or renewal) on the same exact dates as the Service Contract.

A. **Transition and Interim Period Term.**

- (i) The Transition and Interim Period Term shall commence on the Service Contract Date (as such term is defined in the Service Contract and shall expire on the last day of the Interim Period under the Service Contract. For the purposes of this Lease, the first “Transition and Interim Period Term Lease Year” shall mean the period from the Service Contract Date under the Service Contract through the last day of the twelfth (12th) calendar month following the Service Contract Date. (e.g., if the Service Contract Date under the Service Contract is October 1, 2006, the end of the first Transition and Interim Period Lease Year will occur on October 30, 2007.) Each “Transition and Interim Period Term Lease Year” thereafter shall be a full twelve (12) month period, except for the “Final Transition and Interim Period Term Lease Year,” which shall end on the last day of the Interim Period under the Service Contract.

City-PMA Lease

- (ii) During the Transition and Interim Period Term, the Demised Premises shall consist of the Land and improvements fully described in Exhibits "A" and "C."

B. Class A Period Term.

- (i) The Class A Period Term shall commence on the first day of the Class A Period under the Service Contract, which date shall be the day immediately following the last day of the Transition and Interim Period Term unless terminated or renewed previously pursuant to the terms hereof, and shall expire on the last day of the twentieth (20th) Class A Period Term Lease Year. For the purposes of this Lease, the first "Class A Period Term Lease Year" shall mean the period from the first day of the Class A Period under the Service Contract through the last day of the twelfth (12th) calendar month following the first day of the Class A Period under the Service Contract (e.g., if such first day of the Class A Period is October 1, 2008, the end of the first Class A Period Term Lease Year will occur on October 30, 2009.) Each "Class A Period Term Lease Year" thereafter shall be a full twelve month period.
- (ii) Upon or before completion of the Class A Period Term, this Lease may be renewed at the discretion of the Landlord and Tenant pursuant to the renewal of the Service Contract for additional terms for a total period of up to five (5) years.
- (iii) During the Class A Period Term, the Demised Premises shall consist of the Land and improvements fully described in Exhibits "B" and "C."

C. Right to Terminate.

Landlord or Tenant shall have the right to terminate this Lease pursuant to the applicable provisions of the Service Contract including but not limited to termination for cause, termination due to uncontrollable circumstances or exercise of the buy-out option. If the Service Contract is terminated for any reason, this Lease shall likewise be terminated. In the event of termination of this Lease, Landlord or Tenant, as the case may be, shall give the other party written notice of the termination date, which shall be not less than ninety (90) days from the date of the written notice (the "Termination Date").

4. RENT.

As for rent during the Term hereof, the Tenant covenants to pay the Landlord the sum of one dollar (\$1.00) per Lease Year, including each Transition and Interim Period Term Lease Year and Class A Period Term Lease Year, and, which shall be paid in advance on the first day of each Lease Year.

5. **TAXES AND ADDITIONAL RENT.**

A. **Definition of Taxes.** As used herein, the term "Taxes" shall mean and include all real estate taxes and assessments, general or special, ordinary or extraordinary, foreseen or unforeseen, imposed upon the Land, and any existing or future improvements of whatever kind thereto or thereon, and any income received by Tenant from its activities on the Land. Taxes shall include, without limitation, any assessment imposed upon the Demised Premises by any public or private entity by reason of any building being located in a special services district or similar designation. Included under the term "Taxes" shall also be any transfer taxes due in connection with this Lease, City of Philadelphia Business Privilege Tax (if any are due and payable), Net Profits Tax (if any are due and payable), School District Realty Use & Occupancy Tax (if any are due and payable) and other similar taxes and charges. If, due to a future change in the method of taxation, any other tax, however designated, is imposed in substitution for Taxes or any part thereof, or if any rental tax is imposed, then rental or such other taxes shall be included in the word "Taxes."

B. **Payment of Taxes.** Unless otherwise agreed in the Service Contract, during the Term of this Lease, Tenant shall pay or cause to be paid, before each installment is due, any and all Taxes assessed or imposed upon the Demised Premises and against the Land, Tenant's Improvements and the building or any portion thereof. Upon the request of Landlord, Tenant shall provide Landlord with evidence reasonably acceptable to Landlord that each such installment has been paid on or before the date each such installment is due. Notwithstanding the foregoing, Tenant may withhold payment of Taxes to contest the validity of any Taxes, provided Tenant shall give the Landlord such reasonable security to insure payment and to prevent any sale, foreclosure or forfeiture of the Demised Premises by reason of such non-payment as Landlord may reasonably require. Upon final determination of the validity of any such Taxes, Tenant shall pay any judgment or decree rendered against Tenant or Landlord with all proper costs and charges.

6. **CARE OF DEMISED PREMISES.** Tenant agrees that it shall:

A. Comply, at its own cost and expense, with any and all applicable governmental laws, codes, ordinances, rules and regulations of Boards of Fire Underwriters, Ratings Boards or the like (or successor agencies), including without limitation all rules, regulations, ordinances and procedures issued from time to time by the Department of Commerce and any other authorities having jurisdiction over any phase of operation in and about the Demised Premises, and further including the Americans with Disabilities Act of 1990, as amended or hereinafter amended (the "ADA").

B. Unless otherwise set forth in the Service Contract, give Landlord access to the Demised Premises at all reasonable times upon reasonable advance notice, provided

City-PMA Lease

Landlord complies with all provisions of the Service Contract with respect to any entry onto the Demised Premises by Landlord or Landlord's agents or representatives.

C. Subject to the specific terms of the Service Contract, Tenant shall keep the Demised Premises in good order and condition, commit no waste on the Demised Premises, and discharge all maintenance, repair, renewal, and replacement obligations set forth under the Service Contract. Tenant shall assume full repair and maintenance responsibilities for all Tenant's Improvements, existing and new facilities, and shall maintain the same in good order and condition. Maintenance shall include, but not be limited to, landscaping, lawn care, fencing, snow and ice removal, all janitorial services, the repair and/or replacement of damage caused by its employees, patrons or its operation thereon; repair of all equipment, drainage installation, paving, curbs, islands, buildings and improvements; and repainting buildings as necessary.

D. Provide a complete and proper arrangement for the frequent and adequate sanitary handling and disposal, away from the Demised Premises, of all trash, garbage and other refuse caused as a result of the operation of its business.

E. Recognize that Tenant's Improvements attached and/or affixed to the Demised Premises may not be removed or modified except in accordance with the terms of the Service Contract.

F. Upon the termination of this Lease in any manner whatsoever Tenant shall comply with all provisions of the Service Contract relative to Tenant's obligations upon termination. Property not removed by Tenant at the termination of this Lease, however terminated, which property is left after all requirements relative to termination under the Service Contract haven been performed may be considered abandoned and Landlord may dispose of the same as it deems expedient.

G. Not overload, damage or deface the Demised Premises or any part thereof or any of its systems or equipment, or do any act which may make void or voidable any insurance on the Demised Premises or which may render an increased or extra premium payable for insurance.

H. Not make any structural alteration of, improvements to, or addition to the Demised Premises except in accordance with the Service Contract.

I. Except as may be provided under the Service Contract, not install any equipment of any kind or nature whatsoever which may by itself or in combination with other equipment already in the Demised Premises affect or necessitate any changes, replacements or additions to or require the use of the water system, plumbing system, heating system, air conditioning system or the electrical system of the Demised Premises without the prior written consent of the Landlord, which consent shall be at the sole discretion of the Landlord and which consent may be conditioned upon the payment by the Tenant of specific installation costs and/or special monthly charges. Landlord may condition its consent for the installation of equipment which may cause the usage of

City-PMA Lease

excess electricity or water upon the agreement of Tenant to the installation of utility meters, at Tenant's sole cost and expense, whereby the Landlord may determine the additional charges to be paid by Tenant with regard thereto. Nothing in this Subsection I. shall require Tenant to obtain the written consent of Landlord before performing routine maintenance and nonstructural repair of the Demised Premise or any equipment or systems therein.

J. Not without the prior written approval of Landlord, which may be granted or withheld by Landlord in its sole discretion, erect, maintain or display any signs in the Demised Premises. In addition to Landlord's approval, Tenant at its sole cost and expense shall obtain the approval of all other local, state and federal agencies as may be required.

K. Appoint a local representative who shall have the authority to make day-to-day decisions and shall be responsible for coordinating all activities with Landlord. The name, address and telephone number of the local representative is to be submitted to Landlord as set forth in the Service Contract, and Landlord is to be notified immediately of any changes.

L. Except as otherwise set forth in the Service Contract, not use or occupy, or suffer or permit the use or occupancy of, the Demised Premises or any part thereof in any manner or by anything, in any way, in the sole judgment of Landlord, which would impair the appearance, character or reputation of the BRC, the City, or create a nuisance condition at the BRC or the mechanical facilities thereof or tend to impair or interfere with the use of any of the other areas of the BRC or result in discomfort or annoyance or inconvenience to the Landlord or any other tenants or occupants of the BRC, or increase the risk of fire or other casualty to the Demised Premises or to the BRC.

M. Not permit a mechanic's lien for any labor or materials to attach to the whole or any part of the Demised Premises, and Tenant hereby agrees that if a mechanic's lien is filed upon all or any portion of the Demised Premises, Tenant shall protect and save harmless Landlord against any loss, liability or expense whatsoever, by reason thereof and shall defend at its own expense such actions or proceedings as may be necessary to remove such lien from the records within ten (10) days of notice to Tenant of the existence of said lien. Tenant may, however, in good faith and with due diligence contest any mechanics lien or other lien filed or established against all or any portion of the Demised Premises, and in such event may permit such lien or charge to remain undischarged and unsatisfied during the period of such contest and appeal therefrom, if Tenant posts a bond so that no lien attaches to the Demised Premises and if (i) the Landlord is satisfied that Tenant is effectively preventing or staying the execution, foreclosure or enforcement of such lien or charge; or (ii) such contest or appeal shall prevent or stay the execution or enforcement or foreclosure of such lien or charge. If such lien or charge is so stayed and such stay thereafter expires or if by nonpayment of any such lien the Demised Premises or any portion thereof will be subject to loss or forfeiture then Tenant shall forthwith pay and cause to be satisfied and discharged such

City-PMA Lease

lien or charge or secure such payment by posting a bond, in form and substance satisfactory to the Landlord.

N. Tenant shall maintain its existence in good standing in the Commonwealth of Pennsylvania throughout the Term of this Lease.

O. Tenant shall obtain all government approvals necessary to operate and maintain existing improvements included in the Demised Premises and to construct and operate all Tenant Improvements, as defined below, on the Demised Premises.

7. **MAINTENANCE AND UTILITIES**

A. **General Maintenance.** Except as set forth to the contrary in the Service Contract, at all times during the Term, Tenant must, at its sole cost and expense, keep and maintain the Demised Premises and all Tenant's Improvements, fixtures, appurtenances, installations and systems located in or on the Demised Premises including, without limitation, the interior and exterior of the Building, its foundation and structural supports, its roof, its electrical, plumbing, heating, ventilating, and air conditioning, in compliance with all Applicable Laws, in good order and condition, normal wear and tear and damage by insurable casualty excepted (provided that Tenant has at all times obtained and maintained all insurance required under this Lease and/or Service Contract), and Tenant shall not knowingly allow any nuisance to exist or be maintained in, on, or about the Demised Premises or to emanate from the Demised Premises. Without limiting the immediately preceding sentence, the Tenant must, at its sole cost and expense, keep and maintain the Demised Premises in the condition required under the Service Contract, normal wear and tear and damage by insurable casualty excepted. Except as specifically set forth under the Service Contract, Landlord has no obligation under this Lease to either perform or to pay for any maintenance or for any repairs, replacements, or renewals of any kind, nature, or description whatsoever in, on, about or to the Demised Premises or any part of the Demised Premises.

B. **Exterior Maintenance.** Without limiting Section 7(A) above, and subject to the terms set forth in the Service Contract, throughout the Term, Tenant must, at its sole cost and expense, perform all exterior maintenance in, on, and about the Demised Premises to and including the curb line as it abuts the Premises, but not including the cartways themselves. Tenant's exterior maintenance responsibilities shall include, but not be limited to:

(i) all necessary and prudent landscaping to keep the Land attractive and clean, including (a) planting, pruning, removing, replacing and spraying trees, bushes and flowers, as needed, (b) planting or seeding of turf and periodic mowing during the growing season to keep grass neat and trim, and (c) periodic leaf removal during the fall;

City-PMA Lease

(ii) maintenance, repair, and replacement (if irreparably damaged or deteriorated) of all hard surfaces within the Demised Premises, including all sidewalks, driveways, curbs, walkways, recreation paths and trails, and plazas;

(iii) promptly clearing and removing all snow and ice from the Parking Lot and the sidewalks, driveways, roadways, paths, and walkways and all other impervious or semi-pervious surfaces that are within the boundaries of the Demised Premises;

(iv) promptly cleaning and removing all trash, litter, and debris that may come onto the Demised Premises; and

(v) weed, pest and vermin control.

C. **Utilities.** All issues relative to utilities are as set forth with particularity in the Service Contract. Tenant may connect to existing utilities located on the Demised Premises.

8. **SUBLETTING AND ASSIGNING.** To the extent that Tenant is permitted to sublet or assign its rights and obligations under the Service Contract, Tenant shall be permitted to sublet or assign its rights and obligations under this Lease. Notwithstanding anything in this Lease to the contrary, the Term of this Lease shall be exactly coterminous with the "Term" of the Service Contract as such term is defined therein and the Term of this Lease shall commence and expire (whether upon the natural expiration, early termination, renewal, assignment or transfer) on the same exact dates as the Service Contract.

A. **General Restriction.** Except as expressly permitted pursuant to this Section 8 and the Service Contract, Tenant shall not, without the prior written consent of Landlord, assign, hypothecate or suffer or permit any involuntary assignment, attachment or execution upon this Lease or any interest herein or sublet the Demised Premises or any part thereof.

B. **Future Compliance.** Regardless of Landlord's consent, consent to one assignment or subletting shall not be deemed consent to any subsequent assignment or subletting. Landlord may consent to subsequent assignment or subletting or may execute amendments or modifications to this Lease with assignees of Tenant without notifying Tenant or any successor of Tenant, and without obtaining its or their consent thereto, except as set forth above.

9. **FIRE OR OTHER CASUALTY.** Subject to the provisions of this Section 9, if the Demised Premises is damaged by fire or other casualty, the provisions of the Service Contract shall control. In no event shall the Landlord be obligated to repair or restore any such damage. Rent until such repairs are completed shall not be abated or apportioned. Tenant acknowledges notice that (i) Landlord shall not obtain insurance of any kind on the Land, the Demised Premises, Tenant's furniture, furnishings, equipment or fixtures,

alterations, Tenant's Improvements and additions, and (ii) it is Tenant's obligation to obtain such insurance at Tenant's sole cost and expense as provided in Section 11 and the Service Contract.

10. **LIABILITY.**

Damage in General. Unless otherwise provided in the Service Contract, neither Landlord nor Landlord's agents, servants, and employees shall be liable for, and Tenant hereby releases and relieves Landlord and Landlord's agents, servants, and employees from, all liability in connection with any and all damage to or loss of property, loss or interruption of business occurring to Tenant, subtenants, invitees or any other person in or about or arising out of (i) Landlord's negligence or misconduct, and/or (ii) the Demised Premises from, without limitation, (A) any fire, other casualty, accident, occurrence or condition in or upon the Demised Premises; (B) any defect in or failure of: (1) plumbing, sprinkling, electrical, HVAC systems, or any other equipment or systems of the Demised Premises and (2) any stairways, railings or walkways on, or installed on the Demised Premises; (C) any steam, fuel, oil, water, rain or snow that may leak into, issue or flow from any part of the Demised Premises or Land from the drains, pipes or plumbing, sewer or other installation of same, or from any other place or quarter; (D) the breaking or disrepair of any installations, equipment and other systems; (E) the falling of any fixture or well or ceiling materials; (F) broken glass; (G) latent or patent defects; (H) the exercise of any rights by Landlord under the terms and conditions of this Lease; (I) any acts or omissions of the other tenants or occupants of nearby buildings; (J) any acts or omissions of other persons; or (K) theft, Act of God, public enemy, injunction, riot, strike, insurrection, war, court order, or any order of any governmental authorities having jurisdiction over the Demised Premises.

11. **INSURANCE.**

A. **Tenant.** The Tenant shall, at its sole cost and expense, procure and maintain in full force and effect, during the Term and any extension or renewal of this Lease, the types and minimum limits of insurance specified in the Service Contract.

B. **Contractors, Subcontractors, and Consultants.** Tenant shall require that all of its contractors, subcontractors, and consultants obtain and maintain, at their respective cost and expense, the appropriate types and amounts of insurance covering the work and their performance of services, naming Landlord as an additional insured in conformance with the requirements of the Service Contract.

C. **Evidence of Insurance Coverage.**

(i) Certificates of Insurance evidencing the required coverages shall be submitted to Landlord at the City of Philadelphia's Risk Management Division (1515 Arch Street, 14th Floor, Philadelphia, PA 19102) ("Landlord's Risk Manager") at least ten (10) days before commencement of the Term. Tenant shall furnish certified copies of the

City-PMA Lease

original policies required hereunder at any time within ten (10) days after written request by Landlord.

(ii) The insurance requirements set forth herein shall in no way be intended to limit, modify or reduce the indemnifications made in this Lease or to limit Tenant's liability to the limits of the policies of insurance required hereunder.

D. **Inspection of Policies.** Tenant agrees to permit Landlord at all reasonable times and upon ten (10) days notice to inspect the policies of insurance of Tenant with respect to the Demised Premises for which policies or copies thereof are not delivered to Landlord.

E. **Waiver.** Unless provided to the contrary in the Service Contract, Tenant hereby releases Landlord from any and all liability or responsibility to Tenant, for all claims or anyone claiming by, through or under it or them, by way of subrogation or otherwise, for any loss or damage to property which is coverable by insurance, whether or not such insurance is maintained by Tenant.

F. **Failure to Maintain.** In the event Tenant fails to cause such insurance to be maintained, Landlord shall not be limited in the proof of any damages which Landlord may claim against Tenant or any other person or entity to the amount of the insurance premium or premiums not paid or incurred and which would have been payable upon such insurance, but Landlord shall also be entitled to recover as damages for such breach the uninsured amount of any loss, and damages, expenses of suit and costs, including without limitation reasonable cancellation fees, suffered or incurred during any period when Tenant shall have failed or neglected to provide insurance as required herein.

G. **No Limitation.** The insurance requirements set forth herein shall in no way be intended to modify, limit or reduce the indemnifications made in this Lease by Tenant to Landlord or to limit Tenant's liability under this Lease to the limits of the policies of insurance required to be maintained by Tenant.

12. **EMINENT DOMAIN.**

A. **Total or Partial Taking.** If the whole of the Demised Premises shall be condemned or taken either permanently or temporarily for any public or quasi-public use or purpose, under any statute or by right of eminent domain, or by private purchase in lieu thereof, then, in such event, the Term shall cease and terminate from the date when possession is taken thereunder pursuant to such proceeding or purchase.

B. **Award.** In the event of any total or partial taking of the Demised Premises, as provided in Section 12.A. above, Landlord shall be entitled to receive the entire award in any such proceeding and Tenant hereby assigns any and all right, title and interest of Tenant now or hereafter arising in or to any such award or any part thereof and hereby waives all rights against Landlord and the condemning authority, except that

City-PMA Lease

Tenant shall have the right to be fairly compensated by the Landlord for any investments and improvements in the Demised Premises made by Tenant less depreciation and in accordance with the provisions of the Service Contract. Notwithstanding the aforesaid, if Landlord requires Tenant to repair and restore the Demised Premises, Landlord shall make such award available to Tenant for such repair and restoration.

13. **DEFAULT AND REMEDIES.**

A. **Events of Default.** The occurrence of any of the following shall constitute a material breach of the Lease by Tenant and an event of default:

(i) a failure by Tenant to observe and perform any other provision or covenant of this Lease to be observed or performed by Tenant, where such failure continues for ten (10) days after written notice thereof to Tenant provided, however, that if the nature of the default is such that the same cannot reasonably be cured within such ten (10) day period, Tenant shall not be deemed to be in default if Tenant shall within such period commence such cure and thereafter diligently prosecute the same to completion, but in no event for longer than thirty (30) days after written notice to Tenant, except if such default is not capable of cure within said thirty (30) day period then Tenant shall be given such longer cure period as Landlord, in its reasonable discretion, may provide;

(ii) the filing of a petition by or against Tenant for relief as a bankrupt or insolvent or for its reorganization or for the appointment pursuant to any local, state or federal bankruptcy or insolvency law of a receiver or trustee of any part of Tenant's property; or, an assignment by Tenant for the benefit of creditors; or the entry by Tenant into an agreement of composition with creditors; or, the taking possession of the property of Tenant by any local, state or federal governmental officer or agency or court-appointed official for the dissolution or liquidation of Tenant or for the operating, either temporary or permanent, of Tenant's business, provided, however, that if any such action is commenced against Tenant the same shall not constitute a default if Tenant causes the same to be dismissed or discharged within sixty (60) days after the filing of same; or

(iii) an Event of Default by Company under the Service Contract.

B. **Remedies of Landlord.**

(i) Upon the occurrence of any event of default set forth in Section 13.A. or elsewhere in the Lease, Landlord may take the actions set forth in the event of a default by Tenant under the Service Contract

14. **SUBORDINATION.**

A. **Generally.** Landlord represents that it has disclosed to Tenant, on or before the Service Contract Date, any and all liens of any mortgages of Landlord's interest and/or ground leases on the Land executed by Landlord, and/or other

City-PMA Lease

encumbrances of Landlord's interests, now or hereafter placed on the Demised Premises or the Land. Notwithstanding the foregoing, Landlord represents that any party secured by any such mortgage, ground lease or encumbrance upon the Land or the Demised Premises (the "Secured Party") has agreed in writing to recognize this Lease and, in the event of any foreclosure sale or other possession, by a Secured Party, this Lease shall continue in full force and effect.

B. **Rights of Mortgagee.** In the event of any act or omission of Landlord which would give Tenant the right, immediately or after lapse of a period of time, to cancel or otherwise terminate this Lease, or to claim a partial or total eviction, Tenant shall not exercise such right:

(i) Until it has given written notice of such act or omission to the holder of each such mortgage or ground lease whose name and address shall previously have been furnished to Tenant in writing; and

(ii) Until a reasonable period for remedying such act or omission shall have elapsed following the giving of such notice (which reasonable period shall in no event be less than the period to which Landlord would be entitled under this Lease or otherwise, after similar notice, to effect such remedy).

15. **SURRENDER AND HOLDING OVER.**

A. **Surrender.** The Lease shall terminate and Tenant shall deliver up and surrender possession of the Demised Premises on the last day of the Term hereof, and Tenant waives the right to any notice of termination or notice to quit. Tenant covenants that upon the expiration or sooner termination of this Lease, Tenant shall, upon City election to pay fair market value for Tenant Improvements, deliver up and surrender possession of the Demised Premises in the same condition in which Tenant has agreed to keep the same during the continuance of the Lease and in accordance with the terms hereof and the Service Contract, normal wear and tear excepted. If the City does not elect to purchase the improvements made by Tenant, the Tenant shall remove such Tenant Improvements not later than 90 days after the expiration or termination of this Lease or otherwise in accordance with the Service Contract.

B. **Hold Over.** Unless otherwise provided for herein the failure of the Tenant to surrender possession of the Demised Premises upon the expiration or sooner termination of this Lease, Tenant shall pay to Landlord, an amount equal to one-hundred-fifty percent (150%) of the Fair Market Value of rent for the Demised Premises as determined by the Landlord as applied to any period in which Tenant shall remain in possession after expiration or sooner termination of this Lease. Otherwise, such holding over shall be on the terms and conditions set forth in this Lease as far as applicable. Landlord may, but shall not be required to, and only on written notice to Tenant after the expiration of the Term hereof, elect to treat such holding over as an extension of the Term on a month-to-month basis for an additional period of up to one (1) year (as Landlord shall so elect), to be on the terms and conditions set forth in this Lease.

16. **Construction Payment and Performance Bonds.** Prior to the commencement of the construction of any part of the Tenant's Improvements, and at any time that Tenant undertakes any construction on the Demised Premises, Tenant shall obtain and deliver to Landlord, at no cost to Landlord, performance and payment bonds consistent with and pursuant to the bond requirements set forth in the Service Contract.

17. **ESTOPPEL CERTIFICATES.** Tenant shall, from time to time, upon reasonable written request of the Landlord, within a reasonable time execute, acknowledge and deliver to the Landlord a written statement stating the date this Lease was executed and the date it expires; the date Tenant entered into occupancy of the Demised Premises; and certifying that this Lease is in full force and effect and has not been assigned, modified, supplemented or amended in any way; that this Lease represents the entire agreement between the parties and to this leasing; whether all conditions under this Lease to be performed by Landlord have been satisfied; whether on the specified date there are any existing defenses or offsets which either party has against the enforcement of this Lease by the other; whether any Rent has been paid in advance (or specifying any Rent that has been so paid); and any other requested matter affecting this Lease and any statements by Tenant affecting the correctness of the requested statements ("Estoppel Certificate"). It is intended that any such statement delivered pursuant to this Section 17 may be relied upon by a prospective purchaser of Landlord's interest or a mortgagee of Landlord's interest or assignee of any mortgage upon Landlord's interest in the Land.

18. **INSTALLATIONS AND ALTERATIONS BY TENANT.**

A. **No Alterations.** Except as set forth in the Service Contract, Tenant shall make no structural alterations, additions or improvements in or to the Demised Premises without Landlord's prior written consent in each instance obtained. Any such alterations, additions or improvements shall (i) be in accordance with complete plans and specifications approved by Landlord (ii) be performed in a good and workmanlike manner and in compliance with all applicable laws, (iii) be made only by contractors or mechanics approved by Landlord and who (A) carry general liability and property damage insurance in type and amount acceptable to Landlord and (B) have filed lien bonds, lien waivers or the like in such form as is acceptable to Landlord in Landlord's sole discretion, (iv) unless otherwise agreed or set forth in the Service Contract, be made at Tenant's sole expense and at such times and in such manner as Landlord may from time to time designate and (v) become part of the Demised Premises and the property of Landlord, if and at such time as Landlord exercises its right to purchase. Unless otherwise stated in Landlord's consent or set forth in the Service Contract, Landlord reserves the right to require such alterations, additions or improvements placed in or upon the Demised Premises by Tenant, or portions thereof, to be removed by Tenant at Tenant's expense not later than 90 days after the termination or expiration of the Term.

B. **Tenant's Improvements.**

(i) Tenant shall construct or install upon the Demised Premises all improvements, structures, machinery, and equipment necessary to fulfill Tenant's obligations under this Lease and the Service Contract.

(ii) All articles of personal property and all business fixtures, machinery, equipment and furniture owned or installed by Tenant or solely at its expense in the Demised Premises ("Tenant's Improvements") shall vest with the Tenant subject to the Landlord's right to purchase Tenant's Improvements at fair market value upon expiration or early termination of this Lease. If and as set forth in the Service Contract, the Landlord shall have the option to require Tenant to remove Tenant's Improvements at Tenant's sole cost and expense upon such expiration or early termination. If at any time during this Lease, Tenant is required or allowed to remove Tenant's Improvements, Tenant shall repair any damage to Demised Premises caused by any such installation or removal.

C. **No Mechanic's Lien.** In no event shall Landlord be liable for any labor or materials furnished or to be furnished to Tenant upon credit, and no mechanic's or other lien for any such labor or materials shall attach to or affect the reversion or other estate or interest of Landlord in or to the Demised Premises. Whenever and as often as any mechanic's lien shall have been filed against the Tenant's Improvements based upon any act or interest of Tenant or of anyone claiming through Tenant, Tenant shall forthwith take such action by bonding, deposit or payment as will remove or satisfy the lien.

D. **Waiver of Liens.** Tenant shall cause to be executed and delivered to the Landlord a Waiver of Liens to be filed with the Prothonotary of Philadelphia County, Pennsylvania, proof of which shall be supplied to Landlord prior to the commencement of any construction or installation work at the Demised Premises.

E. **Increase in Taxes.** If so required under the terms of the Service Contract and if Tenant shall make or cause to be made at its own expense any alteration, addition or improvement to the Demised Premises (including those improvements required under the Service Contract) which shall result in an increase in the Taxes then Tenant shall pay, in addition to the Rent and other charges, the entire increase in such Taxes attributable to such alteration, addition or improvement. Notwithstanding the foregoing, Tenant may contest the validity of any such increase in Taxes, provided Tenant shall give the Landlord such reasonable security to insure payment and to prevent any sale, foreclosure or forfeiture of the Demised Premises by reason of such non-payment as Landlord may reasonably require. Upon final determination of the validity of any such Taxes, Tenant shall pay any judgment or decree rendered against Tenant or Landlord with all proper costs and charges.

F. **Mortgages.** Tenant may encumber its interests in the leasehold estate created by this Lease and/or its improvements by way of a leasehold mortgage provided that Tenant provides Landlord with prior written notice of any proposed leasehold mortgage, that Landlord shall have previously approved all documents to be executed by Tenant and the leasehold mortgage, which approval shall be granted or not granted in a legally permissible manner and in a manner reasonable for the exercise of Landlord's municipal function.

19. **ENVIRONMENTAL MATTERS.**

A. **Environmental Definitions.**

(i) "Hazardous Substance" shall mean substances brought onto the Demised Premises or Land by Tenant including: (i) asbestos, flammables, volatile hydrocarbons, industrial solvents, explosives, hazardous chemicals, radioactive material, oil, petroleum, petroleum products or by products, crude oil, natural gas, natural gas liquids, hazardous chemical gases and liquids, volatile or highly volatile liquids, and/or synthetic gas, and shall include, without limitation, substances defined as "hazardous substances," "hazardous materials," "hazardous waste," "toxic substances," "pollutants," or "contaminants," as those terms are used in any Environmental Law or at Common Law, and (ii) any and all other materials or substances that any governmental agency or unit having appropriate jurisdiction shall determine in generally applicable regulations from time to time are hazardous, harmful, toxic, dangerous or otherwise required to be removed, cleaned-up, or remediated.

(ii) "Environmental Law" as used in this Lease shall mean all current and future federal, state, and local environmental safety or health laws, statutes, rules, regulations, ordinances, orders, or common law including, but not limited to, reported decisions of any state or federal court and shall include, but not be limited to, the Occupational Safety and Health Act of 1970, as amended (29 U.S.C. § 651 et seq.), the Comprehensive Environmental Response, Compensation and Liability Act of 1980, as amended (42 U.S.C. § 9601 et seq.); the Resource Conservation and Recovery Act, as amended (42 U.S.C. § 6901 et seq.); the Toxic Substances Control Act, as amended, (15 U.S.C. § 2601 et seq.); the Hazardous Materials Transportation Act, as amended (49 U.S.C. § 1801 et seq.); the Clean Air Act, as amended, (42 U.S.C. § 7401 et seq.); the Clean Water Act, as amended (33 U.S.C. § 1251 et seq.); the Oil Pollution Act of 1990, as amended (33 U.S.C. § 2701 et seq.); the Safe Drinking Water Act, as amended (42 U.S.C. § 1251 et seq.); the Pennsylvania Solid Waste Management Act, as amended (35 P.S. § 6018.101 et seq.); the Pennsylvania Hazardous Sites Cleanup Act, as amended (35 P.S. § 6020.101 et seq.); the Pennsylvania Clean Streams Law, as amended (35 P.S. § 691.1 et seq.); the Pennsylvania Underground Storage Tank and Spill Prevention Act 35 P.S. § 6021.10, et seq.; and the Pennsylvania Hazardous Material Emergency Planning and Response Act, as amended (35 P.S. § 6022.101 et seq.), as any of the foregoing may hereinafter be amended; any rule or regulation promulgated pursuant thereto, and any other present or future law, ordinance, rule, regulation, permit or permit condition, order

City-PMA Lease

or directive addressing environmental, health, or safety issues of or by the federal government or the Commonwealth of Pennsylvania or other political subdivision thereof, or any agency, court or body of the federal government, or the Commonwealth of Pennsylvania or any political subdivision thereof, exercising executive, legislative, judicial, regulatory or administrative functions.

(iii) For the purposes of this Environmental Matters Section, the Demised Premises shall include the real estate covered by this Lease; all Improvements thereon; all fixtures or personal property used in connection with the Lease or located on the Demised Premises, including any underground storage tanks, or other storage tanks, pumps, waste oil apparatus or related lines installed by Tenant.

B. Environmental Compliance.

(i) Tenant's conduct and operations shall at all times be in compliance with all statutes, ordinances, regulations, and orders now existing or hereafter enacted by any applicable authority or requirements of common law, including, but not limited to Environmental Laws, as defined herein. Tenant shall obtain all permits, licenses, or approvals and shall make all notifications as required by law. Tenant shall at all times comply with the terms and conditions of any such permits, licenses, approvals, or notifications. In addition, Tenant shall take similar precautions in connection with materials and substances used in Tenant's operations on the Demised Premises which even if not regulated by law or requirements as aforesaid, may or could pose a hazard to the environment or the health or safety of the current or future occupants of the Demised Premises, or the owners or occupants of property adjacent to or in the vicinity of the Demised Premises ("Restricted Activities").

(ii) In accordance with the approvals and notifications required under this Environmental Matters Section and except for the improvements expressly set forth under the Service Contract, Tenant shall not install any storage tanks, including underground storage tanks, pumps, waste oil apparatus or related lines without the Landlord's consent.

(iii) Tenant shall immediately provide to Landlord copies of:

- a. applications or other materials submitted to any governmental agency in compliance with the Environmental Laws;
- b. any notification submitted to any person pursuant to the Environmental Laws with respect to the existence of a potentially adverse environmental impact of a condition on the Demised Premises or related proceedings;
- c. any permit, license, approval, or amendment or modification thereto granted pursuant to the Environmental Laws;

City-PMA Lease

d. upon Landlord's request at reasonable times any record or manifest required to be maintained pursuant to the Environmental Laws;

e. any notice of violation, summons, order, complaint, or any correspondence threatening or relating to any of the foregoing received by Tenant pertaining to compliance with the Environmental Laws or in connection with Restricted Activities; and

f. all plans and specifications relating to any storage tanks, including underground storage tanks, pumps, waste oil apparatus or related lines.

C. **Site Contamination.** Tenant shall not cause contamination of the Demised Premises arising from Restricted Activities or by Hazardous Substances as defined herein. Tenant shall at all times handle Hazardous Substances, regulated substances, as well as all other materials and substances in connection with Restricted Activities in a manner which will not cause contamination, or an unreasonable risk of contamination, of the Demised Premises and in accordance with Applicable Law. For purposes of this Section 20.C., the term "contamination" shall mean the uncontained presence of Hazardous Substances, regulated substances, or damage resulting from Tenant's activities at the Demised Premises or arising from the Demised Premises.

D. **Indemnification.** Tenant shall indemnify, defend and save harmless the Landlord, its officials, officers, agents, boards, commissions, employees, successors and assigns from and against any and all claims (environmental or otherwise), liabilities, damages, impairments, penalties, fines or losses (civil or criminal), including, but not limited to, any penalty or fine imposed by any governmental agency, the expense of remediating, cleaning up or disposing of any Hazardous Substance or regulated materials and all legal expenses and fees incidental to the investigation and defense thereof (including, but not limited to legal fees, litigation fees, expert witness and/or consultant fees), causes of action (collectively, "Environmental Damages"), arising or caused by acts or omissions of the Tenant, including any said costs relating or arising from Tenant's aggravation or contribution to any pre-existing condition. The foregoing indemnity shall survive the expiration or earlier termination of this Lease.

E. **Environmental Removal and Disposal by Tenant.**

(i) Tenant shall be responsible for the proper removal and disposal of all Hazardous Substances or other regulated materials as defined by Local, State and Federal Regulations (whichever is applicable) generated by Tenant, resulting from or arising from Tenant's activities. Such removal and disposal shall include, but not be limited to, Tenant manifesting such regulated substances under Tenant's assigned Environmental Protection Agency Identification Number and ensuring that removal of such regulated materials from the Demised Premises is accomplished in accordance with Local, State and Federal regulations and guidelines. Additionally, environmental contamination, which impacts the Demised Premises as a result of Tenant's improper storage, handling or leakage of any of Tenant's stored substances on the Demised

City-PMA Lease

Premises, shall be the sole responsibility of Tenant. Tenant shall also be responsible for the safe and proper removal of all regulated substances generated by Tenant on the Demised Premises upon the termination of the Lease.

(ii) Upon termination of this Lease for any reason, unless otherwise set forth in the Service Contract or otherwise agreed in writing between Landlord and Tenant, ownership of any storage tanks, including underground storage tanks, pumps, waste oil apparatus or related lines installed by Tenant's Subcontractor shall remain with the Subcontractor and shall not pass to the Landlord. Tenant shall be responsible for the complete removal from the Demised Premises, and the disposal of said storage tanks, including underground storage tanks, pumps, waste oil apparatus or related lines within ninety (90) days of notice of termination under this Lease.

F. **Environmental Audit.** If required by the Service Contract, Tenant shall conduct using a qualified independent environmental auditor reasonably approved by the Landlord, an annual environmental audit of the Tenant's operations, equipment and facilities at the BRC. The Tenant shall submit a current report of the audit results to the Landlord on the annual anniversary of the Commencement Date of this Lease. If the resulting audit report reveals non-compliance by the Tenant, or any other party for which Tenant is responsible, with any Environmental Laws, or indicates that a release of Hazardous Materials has occurred at the BRC, or elsewhere if such non-compliance or release appears to have been attributable to the Tenant's activities, then the Tenant shall be responsible for such non-compliance and shall deliver to Landlord a remediation report ("Compliance Report"), within thirty (30) days of the submission of the Audit Report, containing an explanation of the non-compliance and a remediation plan and schedule for the Landlord's approval. If the Landlord disagrees with any portion of the Compliance Report, the Tenant and the Landlord agree to attempt to resolve the disagreement through informal good faith negotiations. If the parties are unable to reach an agreement through informal negotiations, either party may request the selection of a neutral panel to resolve the dispute. The parties shall jointly select, retain and share the cost of a neutral panel. This neutral panel shall receive submissions from both parties and shall render a written decision which shall be final and binding on the parties. Within thirty (30) days after the Landlord approves the Compliance Report, the Tenant shall commence and expeditiously proceed to complete at its cost and expense the remediation plan set forth therein subject to the conditions, if any, of the Landlord's approval. Notwithstanding the foregoing, if any local, state or federal agency with jurisdiction over the BRC establishes a remediation plan or schedule for the BRC, such agency's plan or schedule shall control. If the Tenant does not complete the required remedial actions in the time periods set forth in the remediation plan or schedule, the Landlord shall have the right, but not the obligation, to enter upon the BRC and implement any remediation actions which it deems necessary or prudent to address such non-compliance. If the Landlord implements any remediation action pursuant to the foregoing sentence, the Tenant shall pay the Landlord's entire cost of performing such work (including an amount for fully allocated administrative charges), without limitation of other claims or damages that the Landlord may have against the Tenant arising out of the terms of this Lease or otherwise.

Notwithstanding anything contained in this Section, subject to the terms of the Service Contract, the Landlord shall have the right to conduct an environmental audit of the Tenant's operations, equipment, facilities and fixtures thereon which, except in the event that the Tenant has failed to perform the annual environmental audit required by this Section, shall be at the Landlord's own cost and expense. Landlord's audit shall have the same effect as an audit by the Tenant and at the discretion of the Landlord may be substituted for the Tenant's annual audit.

G. **Inspection.** Subject to the terms of the Service Contract, Landlord may, at reasonable times after reasonable advance notice and in the presence of an employee or agent of Tenant, enter the Demised Premises to conduct reasonable inspections, tests, samplings, or other investigations in connection with Tenant's obligations under the provisions of this Section 19.G.

H. **Remedies.**

(i) Tenant's breach of any provision of this Section 19. shall be a material breach and an event of default under this Lease and the Landlord shall be entitled to exercise any and all remedies set forth for events of default under the Service Contract.

(ii) The parties agree that the Landlord, in its sole discretion, may obtain specific performance by Tenant of any provision of this Section 19.

I. **Preexisting Conditions.**

(i) As of the date hereof, the Landlord is aware of no preexisting environmental conditions on the Land except for those previously disclosed to the Tenant. Tenant may, at its sole cost and expense, hire a consultant subject to the Landlord's review and approval (such approval not to be unreasonably withheld) to conduct such tests, investigations and studies on the Demised Premises as it deems necessary to determine the environmental condition thereof or to confirm the environmental condition as set forth in the first sentence of this Section.

(ii) Tenant shall give the Landlord immediate notice should it subsequently discover any Hazardous Substance.

(iii) Upon the discovery of any Hazardous Substance, Tenant shall have the duty immediately to: (1) cease and/or appropriately modify all activities and implement all appropriate safety, health and environmental controls and precautions, (2) notify the Landlord of the situation, and (3) notify governmental agencies as required under Environmental Law or other applicable law.

(iv) To the extent permitted by law and subject to the conditions stated herein, the Landlord shall hold harmless Tenant for any preexisting Hazardous

City-PMA Lease

Substances identified on the Demised Premises pursuant to subsections 19.I.(i)(ii). Notwithstanding anything contained in this Lease or otherwise, nothing in this Lease shall waive, or be construed to waive, any power or authority, privilege or defense, immunities or limitations of the Landlord under all applicable laws, including but not limited to Act No. 142, 42 Pa. C.S.A §§ 8501, et seq.

(v) Subject to the terms of the Service Contract, Tenant shall provide reasonable access to Landlord, its agents and contractors, to the Demised Premises for the purpose of inspecting, cleaning up, controlling or otherwise remediating preexisting Hazardous Substances.

J. **No Third Party Rights.** This Section shall create no third party interests or causes of action and the Landlord expressly reserves the right to compel any party responsible for such preexisting environmental conditions to remediate at its own cost and expense.

K. **Survival.** The provisions of this Section 19 shall survive the termination of Tenant's tenancy or of this Lease. No subsequent modification or termination of this Lease by agreement of the parties or otherwise shall be construed to waive or to modify any provision of this Section 19 unless the termination or modification agreement or other document so states in writing.

L. **End of Occupancy.** If required by the Service Contract, upon the vacating of any portion of the Demised Premises by Tenant, Tenant shall obtain, pursuant to specifications approved by the Landlord (which approval shall be given or not given in a legally permissible manner and in a manner reasonable for the exercise of the Landlord's municipal function) and the Service Contract, an environmental assessment of the portion of the Demised Premises being vacated by Tenant at the Tenant's sole expense. Any environmental contamination disclosed in the environmental assessment prepared at the termination of the Lease not also disclosed in any environmental assessment prepared prior to the Commencement Date at Tenant's sole cost shall be the responsibility of the Tenant (unless Tenant can provide clear evidence that such contamination existed prior to the Commencement Date) and the Tenant shall be obligated promptly to effect the remediation of such environmental contamination and to have prepared at the Tenant's expense a post-remediation environmental assessment by a qualified professional environmental consultant acceptable to the Landlord substantiating completion of such remediation in accordance with then applicable law and consistent with industry standards. Tenant shall furnish to the Landlord true and complete copies of all environmental assessments of the Demised Premises including copies of all sampling and other data obtained as a result of the environmental assessments. Tenant shall provide the Landlord reasonable advance notice of and shall grant the Landlord, its agents and contractors, reasonable access to the Demised Premises during any environmental assessment activities and the right to accompany persons conducting any environmental assessments and to monitor the same.

City-PMA Lease

20. **SIGNS.** Tenant shall not, without the prior written approval of Landlord, erect, maintain or display any signs at the BRC or on the grounds or exterior of buildings on the Demised Premises. The term "signs" as used herein shall mean advertising signs, billboards, identification signs or symbols, posters, or any similar devices. Prior to the erection, construction or placing of any sign at the BRC or upon the Demised Premises (except the interior of any buildings), Tenant shall submit to Landlord for approval drawings, sketches, design, and dimensions of such signs. Any conditions, restrictions or limitations with respect to the use thereof as stated by Landlord, in writing, shall become conditions of this Lease.

21. **TENANT'S REPRESENTATIONS AND WARRANTIES.** Tenant represents and warrants to Landlord that:

A. **Good Standing.** Tenant is in good standing under the laws of the Commonwealth of Pennsylvania.

B. **No Violation.** Neither the execution by Tenant of this Lease nor the performance by Tenant of the terms hereof will conflict with or violate any other agreement or instrument to which Tenant is a part or any writ, order or decree by which Tenant is bound.

C. **No Litigation.** There is no litigation currently pending or threatened which could adversely affect Tenant's ability to perform any of its obligations hereunder.

22. **NON-DISCRIMINATION**

A. **Local Requirements.**

(i) This Lease is entered into under the terms of the Philadelphia Home Rule Charter and in the exercise of the privileges herein granted, Tenant shall not discriminate nor permit discrimination against any person because of race, color, religion, national origin, sex or ancestry. Without limiting any other provision of this Lease, Tenant agrees to comply with the Fair Practices Ordinance of the City of Philadelphia (Section 9-1100 of the Philadelphia Code) as referenced in the Service Contract, as amended from time to time.

(ii) Tenant covenants and agrees that in accordance with Chapter 17-400 of the Philadelphia Code, payment or reimbursement of membership fees or other expenses associated with participation by its employees in an exclusionary private organization, insofar as such participation confers an employment advantage or constitutes or results in discrimination with regard to hiring, tenure of employment, promotions, terms, privileges or conditions of employment, on the basis of race, color, religion, national origin, ancestry, sex, sexual orientation or physical handicap constitutes a substantial breach of this Lease entitling Landlord to all rights and remedies provided in this Lease or otherwise available in law or equity.

City-PMA Lease

a. Tenant agrees to include the immediately preceding Section, with appropriate adjustments for the identity of the parties, in all subcontracts, which are entered into for work to be performed pursuant to this Lease.

b. Subject to the terms of the Service Contract, Tenant further agrees to cooperate with the Commission on Human Relations of the City of Philadelphia in any manner which the said Commission deems reasonable and necessary for the Commission to carry out its responsibilities under Chapter 17-400 of the Philadelphia Code. Failure to so cooperate shall constitute a substantial breach of this Lease entitling Landlord to all rights and remedies provided herein.

23. **QUIET ENJOYMENT.**

A. **Performance by Tenant.** Upon payment by Tenant of Rent and upon the observance and performance by Tenant of all the terms, covenants, conditions, provisions and agreements of this Lease on Tenant's part to be observed and performed, Tenant shall peaceably and quietly hold and enjoy the Demised Premises for the Term of this Lease without hindrance or interruption by Landlord or by any person or persons lawfully claiming or holding by, through or under Landlord, subject, nevertheless, to the terms, covenants, conditions and provisions of this Lease, to all other agreements, conditions, restrictions and encumbrances of record and to all mortgages, installment sale agreements and underlying leases of record to which this Lease is, or shall become subject and subordinate.

B. **Landlord's Right to Enter.** Notwithstanding the provisions of Section 23.A. but subject to the terms of the Service Contract, Landlord shall have the right, upon reasonable oral or written notice to Tenant (or without any notice whatsoever in case of emergency), to enter upon the Demised Premises for the purpose of inspecting same and/or of making any repairs thereto and performing any work thereon (including any which may be necessary by reason of Tenant's failure to make any repairs or perform any maintenance work required to be performed by Tenant, and also including the right to install, maintain, repair, replace or remove water or sewer pipes, electrical lines, gas pipes, or any other utilities or services on the Demised Premises). The privilege and right of entry shall be exercised at reasonable times and at reasonable hours, and without unreasonable interruption or disruption to Tenant's activities and operations in the Demised Premises.

24. **INDEMNIFICATION, HOLD HARMLESS, LIABILITY.**

A. **Indemnity of Landlord.** Subject to the terms of the Service Contract, Tenant shall indemnify, defend and hold harmless Landlord, its officers, boards and commissions, employees and agents, from and against any and all losses, costs (including, but not limited to, litigation and settlement costs and counsel fees and

City-PMA Lease

expenses), claims, suits, actions, damages, liability and expenses, occasioned wholly or in part by Tenant's failure to perform any of its obligations under this Lease or negligence, omission or fault, or the negligence, omission or fault of Tenant's agents, subcontractors, independent contractors, suppliers, employees or servants in connection with this Lease, including, but not limited to, those in connection with loss of life, bodily injury, personal injury, damage to property, contamination or adverse effects on the environment, intentional acts, failure to pay any Subcontractors and suppliers, any breach of this Lease of the Service Contract, and any infringement or violation of any proprietary right (including, but not limited to, patent, copyright, trademark, service mark and trade secret).

B. **Defense of Proceedings.** In case any action or proceeding is brought against Landlord by reason of any matter referred to in this Section 24, Tenant, upon written notice from Landlord, shall at Tenant's sole cost and expense, resist or defend such action or proceeding by counsel.

C. **Survival of Obligations.** The provisions of this Section 24 as they apply to occurrences, or actual or contingent liabilities arising during the Term of this Lease shall survive the expiration or any earlier termination of this Lease.

D. **Application of Environmental Obligations.** Except as otherwise set forth in or limited by this Lease or the Service Contract, the indemnification and liability to the Landlord by Tenant as set forth above, shall also apply to any and all environmental matters and shall also include but not be limited to Tenant's duty to pay any fines and satisfy any punitive measures imposed upon Landlord by governmental agencies and Tenant's duty to pay Landlord for any costs or liability incurred by Landlord in connection with safety measures, containment and/or clean-up of environmental matters.

25. **BROKERAGE.** Tenant represents and warrants that Tenant has dealt with no broker or agent in connection with the consummation of this Lease.

26. **LANDLORD STATUS.** Landlord warrants and represents that it shall remain in existence as a body corporate and politic of the Commonwealth of Pennsylvania for the entire Term of the Lease. Landlord's obligations hereunder shall be binding upon Landlord only for a period of time that Landlord is in ownership of the Demised Premises; and, upon termination of that ownership, Tenant, except as to any obligations which have then matured, shall look solely to Landlord's successor in interest in the Demised Premises for the satisfaction of each and every obligation of Landlord hereunder.

27. **NOTICES.** All notices, requests and other communications under this Lease shall be effectively given only if in writing and sent by United States registered or certified mail, return receipt requested, postage prepaid, or by a nationally recognized and receipted overnight courier service (such as Federal Express) guaranteeing next business day delivery, addressed as follows:

City-PMA Lease

If intended for Landlord:

Philadelphia Water Department
1101 Market Street, 5th Floor
Philadelphia, PA 19107
Attention: Water Commissioner

And:

Department of Public Property
Municipal Services Building
1401 JFK Boulevard, 10th Floor
Philadelphia, PA 19102
Attention: Commissioner

If intended for Tenant:

Philadelphia Municipal Authority
1515 Arch Street, 9th Floor
Philadelphia, PA 19102
Attn: Executive Director

With a copy to:
Philadelphia Biosolids Services, LLC
1800 Bering Drive, Suite 1000
Houston, TX 77057
Attn: General Counsel

or to such other addresses of which Landlord or Tenant shall have given notice as herein provided. All such notices, requests and other communications shall be deemed to have been sufficiently given for all purposes hereof on the third (3rd) business day after proper mailing thereof (in the case of United States registered or certified mail) or on the date of the delivery thereof to a courier service as aforesaid, and may be given on behalf of either party by its counsel.

28. **CERTIFICATION OF NON-INDEBTEDNESS.**

A. **Tenant Not Indebted.** Tenant hereby certifies and represents that Tenant and Tenant's officers and directors are not currently indebted to Landlord and will not at any time during the term of this Lease (including any extensions or renewals thereof) be indebted to Landlord, for or on account of any delinquent taxes (including, but not limited to, taxes collected by Landlord on behalf of the School District of Philadelphia),

City-PMA Lease

liens, judgments, fees or other debts for which no written agreement or payment plan satisfactory to Landlord has been established. In addition to any other rights or remedies available to Landlord at law or in equity, Tenant acknowledges that any breach or failure to conform to this certification may, at the option of Landlord, result in the withholding of payments otherwise due to Tenant and, if such breach or failure is not resolved to Landlord's satisfaction within a reasonable time frame specified by Landlord in writing, may result in the offset of any such indebtedness against said payments and/or the termination of this Lease for default.

B. **Requirement for subcontractors.** Tenant shall require all subcontractors performing work in connection with this Lease to be bound by the following provision and Tenant shall cooperate fully with Landlord in exercising the rights and remedies described below or otherwise available at law or in equity:

"Subcontractor hereby certifies and represents that Subcontractor and Subcontractor's parent company(ies) and subsidiary(ies) are not currently indebted to Landlord and will not at any time during the term of Tenant's Lease with Landlord, including any extensions or renewals thereof, be indebted to Landlord, for or on account of any delinquent taxes (including, but not limited to, taxes collected by Landlord on behalf of the School District of Philadelphia), liens, judgments, fees or other debts for which no written agreement or payment plan satisfactory to Landlord has been established. In addition to any other rights or remedies available to Landlord at law or in equity, Subcontractor acknowledges that any breach or failure to conform to this certification may, at the option and direction of Landlord, result in the withholding of payments otherwise due to Subcontractor for services rendered in connection with the Lease and, if such breach or failure is not resolved to Landlord's satisfaction within a reasonable time frame specified by Landlord in writing, may result in the offset of any such indebtedness against said payments otherwise due to Subcontractor and/or the termination of Subcontractor for default (in which case Subcontractor shall be liable for all excess costs and other damages resulting from the termination)."

29. **NORTHERN IRELAND.**

A. In accordance with Section 17-104 of The Philadelphia Code, Tenant by execution of this Lease certifies and represents that it currently is and will during the term of this lease continue to be, in compliance with the fair employment principles embodied in the "MacBride Principles" (i) Tenant (including any parent company, subsidiary, exclusive distributor or company affiliated with Tenant) does not have, and will not have at any time during the term of this Lease (including any extensions thereof), any investments, licenses, franchises, management agreements or operations in Northern Ireland or (ii) no product to be provided to the City under this Lease will originate in Northern Ireland unless Tenant has implemented the fair employment principles embodied in the MacBride Principles.

B. In the performance of this Lease, Tenant agrees that it will not utilize any suppliers, subcontractors or subconsultants at any tier (i) who have (or whose parent,

subsidiary, exclusive distributor or company affiliate have) any investments, licenses, franchises, management agreements or operations in Northern Ireland or (ii) who will provide products originating in Northern Ireland unless said supplier, subconsultant or subcontractor has implemented the fair employment principles embodied in the MacBride Principles. Tenant further agrees to include the provisions of this Subsection (b), with appropriate adjustments for the identity of the parties, in all subcontracts and supply agreements which are entered into in connection with the performance of this Lease.

C. Tenant agrees to cooperate with the City's Director of Finance in any manner which the said Director deems reasonable and necessary to carry out the Director's responsibilities under Section 17-104 of The Philadelphia Code. Tenant expressly understands and agrees that any false certification or representation in connection with this Section 29 and/or any failure to comply with the provisions of this Section 29 shall constitute a substantial breach of this Lease entitling the City to all rights and remedies provided in this Lease or otherwise available in law (including, but not limited to, Section 17-104 of The Philadelphia Code) or equity. In addition, it is understood that false certification or representation is subject to prosecution under Title 18 Pa.C.S.A. Section 4904.

30. **MISCELLANEOUS PROVISIONS.**

A. **Force Majeure.** Subject to the terms of the Service Contract, Landlord and Tenant shall be excused for the period of any delay in the performance of any obligations hereunder when prevented from so doing by cause or causes beyond their control which shall include, without limitation, all labor disputes, inability to obtain any material or services, civil commotion or Acts of God.

B. **Successors.** The respective rights and obligations provided in this Lease shall bind and shall inure to the benefit of the parties hereto, their legal representatives, heirs, successors and assigns, provided, however, that no rights shall inure to the benefit of any successors of Tenant unless Landlord's written consent for the transfer to such successor has first been obtained as provided in Section 8.

C. **Governing Law.** This Lease shall be construed, governed and enforced in accordance with the laws of the Commonwealth of Pennsylvania.

D. **Severability.** If any provisions of this Lease or portions thereof shall be held to be invalid, void or unenforceable, the remaining provisions of this Lease or portions thereof shall in no way be affected or impaired and such remaining provisions or portions thereof shall remain in full force and effect.

E. **Captions.** Any heading preceding the text of the several Sections and Subsections hereof are inserted solely for the convenience of reference and shall not constitute a part of this Lease, nor shall they affect its meaning, construction or effect.

City-PMA Lease

F. **Certain Definitions.** As used in this Lease, the word "person" shall mean and include, where appropriate, an individual, corporation, partnership or other entity; the plural shall be substituted for the singular, and the singular for the plural where appropriate; and words of any gender shall mean and include any other gender.

G. **Waiver of Jury Trial.** It is mutually agreed that Landlord and Tenant hereby waive trial by jury in any action, proceeding or counterclaim brought by either of the parties hereto against the other as to any matters arising out of or in any way connected with this Lease.

H. **Time of the Essence.** It is expressly understood and agreed that with respect to all responsibilities, covenants and conditions of Tenant herein, time is of the essence of this Lease. All payments are due by 4:00 p.m. on the due date. Any payment submitted by Tenant to cure a financial default must be received no later than 4:00 p.m. on the final day of the cure period or such payment will not be accepted by Landlord as a cure of the default.

I. **Entire Agreement.** This Lease (including the Exhibits and any Riders hereto) contains all the agreements, conditions, understandings, representations and warranties made between the parties hereto with respect to the subject matter hereof and supersedes all prior negotiations and proposals (either written or oral). This Lease may not be modified or terminated orally or in any manner other than by an agreement in writing signed by both parties hereto or their respective successors in interest. In the event of conflict between the terms of this Lease and the Service Contract, the terms of the Service Contract shall control.

J. **Further Assurances.** PMA shall, from time to time at the request of the Company or the Lender, take any and all actions, including without limitation the amendment of the Financing Documents, the Service Contract, the Lease or the execution of new or additional consents or other documents, which may be reasonably necessary or helpful to facilitate the financing of the Class A Facilities by Tenant with a Lender; provided, however, that such amendment or other document shall not in any way affect the Term or affect adversely any rights of PMA or the Company pursuant to this Lease.

K. **Subject to Service Contract.** It is intended and agreed by the Parties that all substantive responsibilities relative to the Demised Premises be and are set forth in the Service Contract. The terms of this Lease, to the extent they conflict with the Service Contract, shall be subject to same. To the extent that provisions in this Lease add to the provisions of the Service Contract, such shall be interpreted in light of the Service Contract obligations and shall be made and interpreted consistently with same.

L. **Third Party Beneficiaries.** The Company is a third-party beneficiary to this Lease. Otherwise, the rights and obligations of PMA and the City as enumerated in this Lease are for the sole and exclusive benefit of the City and PMA.

City-PMA Lease

[Signature Page Follows]

City-PMA Lease

IN WITNESS WHEREOF, the parties hereto have caused this Lease to be executed by their duly authorized officers or representatives as of the day and year first above written.

LANDLORD:

**City of Philadelphia
Department of Public Property**

Approved as to Form

Per: _____
Law Department
Romulo L. Diaz, Jr.
City Solicitor

By: _____
Commissioner

TENANT:

Philadelphia Municipal Authority

Witness: _____

By: _____
Title: _____

(Corporate Seal)

MASTER LEASE EXHIBITS

- (A) DEMISED PREMISES TRANSITION AND INTERIM PERIOD TERM**
- (B) DEMISED PREMISES CLASS A PERIOD TERM**
- (C) ROLLING STOCK TO BE LEASED AS FIXTURES**
- (D) SERVICE CONTRACT (City of Philadelphia & Philadelphia Municipal Authority)**
 - (1) APPENDICIES 1-15**
 - (2) SERVICE AGREEMENT (Philadelphia Municipal Authority & Philadelphia Biosolids Services, LLC, as provided in Exhibit "B")**
 - (3) SERVICES CONTRACT TRANSACTION DOCUMENTS**
 - MASTER LEASE (City and the Philadelphia Municipal Authority)**
 - LEASE (Philadelphia Municipal Authority and Philadelphia Biosolids Services, LLC as provided in Exhibit "B" of this Ordinance)**
 - GUARANTY (from SYNAGRO TECHNOLOGIES, INC.)**
 - PERFORMANCE BOND FORM**
 - PAYMENT BOND FORM**

EXHIBIT "A"
DEMISED PREMISES TRANSITION AND INTERIM PERIOD TERM AREA

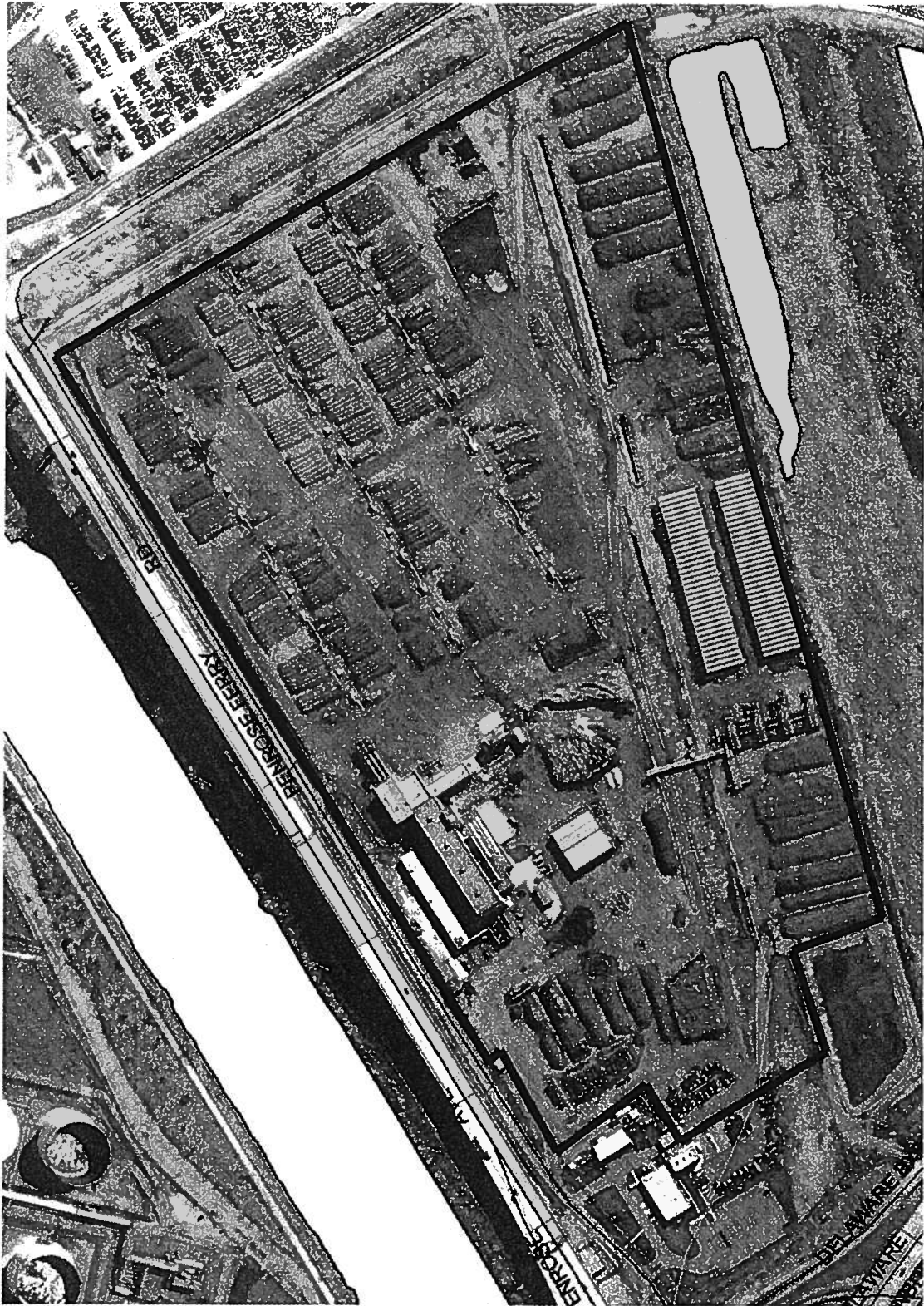

**SURVEY OF DEMISED PREMISES
TRANSITION AND INTERIM PERIOD TERM AREA**

All that certain lot or piece of ground situate in the 40th Ward of the City of Philadelphia, described as follows:

BEGINNING at a point located the two following courses from the point of a railroad spike in the bed of Penrose Ferry Road (150 wide, legally open). Said railroad spike being North $83^{\circ}53'56''$ East, a distance of 75.020 feet from the midpoint of the East Face of the Forth Pier south of Platt (Penrose Avenue) Bridge, on the west side of the Schuylkill River and the intersection of this line with the center point of the CSX Transportation, Inc.'s Railroad Right-of-way (former Philadelphia, Baltimore and Washington Railroad); Thence, a) Extending from said Railroad Spike, South $28^{\circ}18'52''$ East, a distance of 44.290 feet to a point; Thence, b) Leaving said line and extending South $61^{\circ}41'57''$ West, a distance of 68.101 feet to a point; Said point being the True Point and Place of Beginning; Thence, from the Point of Beginning, 1) South $28^{\circ}18'52''$ East, a distance of 1,141.928 feet to a point; Thence, 2) South $20^{\circ}47'50''$ East, a distance of 382.196 feet to a point; Thence, 3) South $78^{\circ}08'50''$ West, a distance of 2,040.636 feet to a point; Thence, 4) North $13^{\circ}25'45''$ West, a distance of 2,55.331 feet to a point; Thence, 5) South $77^{\circ}37'00''$ West, a distance of 278.490 to a point; Thence, 6) North $29^{\circ}12'54''$ West, a distance of 389.282 feet to a point; Thence, 7) North $60^{\circ}47'06''$ East, a distance of 90.716 feet to a point; Thence, 8) North $29^{\circ}12'54''$ West, a distance of 167.333 feet to a point; Thence, 9) North $60^{\circ}47'06''$ East, a distance of 347.013 feet to a point; Thence, 10) North $29^{\circ}12'54''$ West, a distance of 56.383 feet to a point; Thence, 11) North $61^{\circ}41'58''$ East, a distance of 1,781.154 feet to the Point of Beginning.

The Area of Property Lease of the Philadelphia Water Department's Biosolids Recycling Center, described herein, is according to a plan (Reference Plan Y-567-ROW DWG) entitled "Proposed Lease of Biosolids Recycling Center", dated January 9, 2006, prepared by Philadelphia Water Department Survey Unit, 3585 Fox Street, Philadelphia, PA, 19129.

CONTAINING in Area 2,561,595.770 square feet or 58.800 acres, more or less.

EXHIBIT "B"
DEMISED PREMISES CLASS A PERIOD TERM AREA



EXHIBIT "C"
ROLLING STOCK TO BE LEASED AS FIXTURES

# Units	Equipment Type	City Property #
1	Forklift	##### (electric)
1	Sweepers	950140
1	Bobcat	990118
5	Peterbilt trucks	020001, 020002, 020003, 020004, 020005
6	Loaders	030009, 030010, 030034, 030035, 030036, 030037
1	Ottawa jockey, Trailer	970109, 970116
1	Scat turner	940418
1	Flusher water truck	920174

EXHIBIT "D"

SERVICE CONTRACT

[AS APPROVED BY ORDINANCE]

SERVICE CONTRACT

Table of Contents

ARTICLES

- I DEFINITIONS AND INTERPRETATION**
- II REPRESENTATIONS AND WARRANTIES**
- III TRANSITION TO OPERATION OF EXISTING FACILITIES**
- IV BIOSOLIDS SERVICES**
- V OWNERSHIP AND FINANCING**
- VI DESIGN AND CONSTRUCTION OF THE CLASS A FACILITIES**
- VII PERFORMANCE OF BIOSOLIDS SERVICES**
- VIII SERVICE FEE**
- IX SERVICE COORDINATION AND CONTRACT ADMINISTRATION**
- X BREACH, DEFAULT, TERMINATION, AND DISPUTE RESOLUTION**
- XI TERM AND SURVIVAL OF CERTAIN PROVISIONS UPON
TERMINATION**
- XII GENERAL PROVISIONS**
- XIII STANDARD CITY CONTRACT PROVISIONS**

BIOSOLIDS RECYCLING CENTER OPERATION SERVICE CONTRACT

This BIOSOLIDS RECYCLING CENTER OPERATION SERVICE CONTRACT is made and dated _____ 2006 between the CITY OF PHILADELPHIA ("City") and the PHILADELPHIA MUNICIPAL AUTHORITY, a body corporate and politic of the Commonwealth of Pennsylvania ("PMA").

RECITALS

- A. The City is a municipal corporation and a body corporate and politic organized under the laws of the Commonwealth of Pennsylvania, having adopted the Philadelphia Home Rule Charter under the provisions of the First Class City Home Rule Act of April 21, 1949, P.L. 665.
- B. PMA is a body corporate and politic, organized under the provisions of the Pennsylvania Municipality Authorities Act of 1945 (the Act of May 2, 1945, P.L. 382, as amended) pursuant to ordinances of the Council of the City of Philadelphia.
- C. City desires to undertake a certain long-term biosolids processing project consisting of: (1) the design, construction, financing and ownership of a Class A biosolids processing facility ("Class A Facilities"); (2) the interim operation and maintenance of the City's existing biosolids facility and disposal operations during the design and construction of the Class A Facilities; and (3) the long-term operation and maintenance of the Class A Facilities and the disposal or utilization of all City biosolids, collectively "Biosolids Services."
- D. PMA and Philadelphia Biosolids Services, LLC. ("Company") have entered into a Service Agreement for the provision of Biosolids Services on this same date, a copy of which is attached hereto as Exhibit "A," pursuant to which Company, acting as a subcontractor to PMA shall perform certain obligations required of PMA hereunder, and shall receive certain performance from PMA.
- E. On _____, 2006, the Council of the City of Philadelphia approved two ordinances, Bill No. _____, signed by the Mayor of the City of Philadelphia on _____, 2006, and Bill No. _____, signed by the Mayor of the City of Philadelphia on _____, 2006 (collectively, the "Ordinances"), copies of which are attached hereto, as Exhibits pursuant to which the Council of the City and the Mayor have authorized the execution of this Service Contract and have duly empowered City and PMA to undertake the Biosolids Services; and
- F. PMA has agreed to provide the Biosolids Services, and the Parties hereto desire to enter into this Service Contract in accordance with the Ordinances.

G. By resolution dated _____ 2006, the Board of Directors of PMA has authorized its Chairman to execute this Service Contract.

It is, therefore, agreed as follows:

ARTICLE 1

DEFINITIONS AND INTERPRETATION

1.1 Definitions. As used in this Service Contract, including the Appendices attached hereto, the following terms shall have the meanings set forth below:

"Acceptance Test Plan" has the meaning specified in Section 6.12 of the Service Contract.

"Acceptance Tests" means the Acceptance Tests set forth in Appendix 6.

"Acceptance Test Standards" means those standards which must be demonstrated by the Company as being met, by way of Acceptance Testing in accordance with Appendix 6 or any Acceptance Test Plan approved by the City and PMA pursuant to Appendix 6 "Acceptance Test Standards Achievement" means demonstration by the Company in accordance with Article 6 and Appendix 6 that the Acceptance Tests for the Class A Facilities have been conducted and the Acceptance Test Standards in Appendix 6 have been achieved.

"Act" means the Pennsylvania Municipality Authorities Act of 1945, as amended, supplemented, superseded and replaced from time to time.

"Additional Capital" means funds provided by Company, apart from Project Financing, used to fund construction, which amount of funds shall be \$7,000,000.00.

"Affiliate" means any person, corporation or other entity directly or indirectly controlling or controlled by another person, corporation or other entity or under direct or indirect common control with such person, corporation or other entity.

"Alternative Fuel" shall mean any fuel which the City and PMA agree to be used as a substitute for natural gas during the Class A Period.

"Annual Report" has the meaning specified in Section 9.5 B.

"Appendix" means an appendix to this Service Contract, as the same may be amended or modified.

"Applicable Law" means any federal, state, City, local, or other law, statute, code, charter, regulation, rule, ordinance, mandate, judgment, order, decree, Government Approval, permit, license, or other law or governmental requirement or restriction (or any binding interpretation or administration of the foregoing by a governmental authority) that applies to any

aspect of the Biosolids Services or obligation of either party to this Service Contract, whether now or hereafter in effect.

"ATSA Date" means the day after Acceptance Test Standards Achievement, in accordance with Section 6.15.

"Beneficial Use" means any application of Product to land specifically designed to take advantage of the nutrient and other characteristics of this material to improve soil fertility or structure and thereby further some natural resource management objective, or utilization as a fuel substitute for natural fuels such as coal, petroleum products and others.

"Billing Period" means each calendar month in each Contract Year, except that (1) the first Billing Period shall begin on the Commencement Date and shall continue to the last day of the month in which the Commencement Date occurs and (2) the last Billing Period shall end on the last day of the Term. Any computation made on the basis of a Billing Period shall be adjusted on a pro rata basis to take into account any Billing Period of less than the actual number of days in the month to which such Billing Period relates.

"Biosolids Services" means the complete management of City Biosolids by PMA in accordance with the provisions of this Service Contract, including the operation and maintenance of the Operated Facilities, acceptance, dewatering, processing, handling, transportation, marketing and utilization or disposal of all City Biosolids and all Product, and the permitting, design, financing, construction, testing, and operation of the Class A Facilities and related obligations.

"BRC" means the Biosolids Recycling Center, including land and improvements.

"BRC Site" means the BRC real property area to be utilized by PMA as set forth in the City Lease.

"BTU" means British Thermal Unit, a unit of heat measurement.

"CERCLA" means the Comprehensive Environmental Response, Compensation and Liability Act, 42 U.S.C.A. § 9601 et seq. (West 1983 & Supp. 1989), as amended or superseded, and the regulations promulgated thereunder.

"Change in Law" means any of the following acts, events or circumstances to the extent that compliance therewith increases the cost of or time for performing or increases the scope of the party's obligations hereunder:

- (1) the adoption, amendment, promulgation, issuance, modification, repeal or written change in administrative or judicial interpretation of any Applicable Law on or after the Service Agreement Date, unless such Applicable Law was on or prior to such date duly adopted, promulgated, issued or otherwise officially modified or changed in interpretation, in each case in final form, to become effective without any further action by any Governmental Body;

(2) the order or judgment of any Governmental Body issued on or after the Service Agreement Date (unless such order or judgment is issued to enforce compliance with Applicable Law which was effective as of such date) to the extent such order or judgment is not the result of willful or negligent action, error or omission or lack of reasonable diligence of the City or of PMA, whichever is asserting the occurrence of a Change in Law; provided, however, that the contesting in good faith or the failure in good faith to contest any such order or judgment shall not constitute or be construed as such a willful or negligent action, error or omission or lack of reasonable diligence; or

(3) the imposition of a term, condition or requirement which is more stringent or burdensome than the Contract Standards, or than Applicable Law as of the Service Agreement Date, in connection with the issuance, renewal or failure of issuance or renewal of, any Governmental Approval to the extent that such occurrence is not the result of willful or negligent action, error or omission or a lack of reasonable diligence of the City or PMA, whichever is asserting the occurrence of a Change in Law; provided, however, that the contesting in good faith or the failure in good faith to contest any such occurrence shall not be construed as such a willful or negligent action or lack of reasonable diligence.

It is specifically understood, however, that none of the following shall constitute a "Change in Law":

(a) the failure of the appropriate Governmental Body to approve the Company's staffing plan or any changes therein over time;

(b) a change in the nature or severity of the actions typically taken by a Governmental Body to enforce compliance with Applicable Law which was effective as of the Service Agreement Date;

(c) with regard to Product utilization, transportation, storage or disposal: (i) during the Interim Period, a change in local, county, regional or other Applicable Law, except applicable federal law and state law in Pennsylvania, Maryland and Virginia; and (ii) during the Class A Period, a change in local, county, regional or other Applicable Law, except applicable federal law and state law in Pennsylvania.

"Change Order" means a change in the Biosolids Services that requires the approval of City.

"City" means the City of Philadelphia, Pennsylvania.

"City Biosolids" means all liquid sludge from the City's water pollution control plants, all of which is delivered by the City to the BRC Site, including Nonconforming City Biosolids but not including biosolids classified as Hazardous under Applicable Law.

"City Engineer" means an engineer employed by City and designated by City to the Company in writing as the PMA Engineer.

City-PMA Service Contract

“City Fault” means any one or more of the following: (1) the untruth of any material representation made by the City under this Service Contract or any material breach, failure, nonperformance or noncompliance by the City with its obligations under this Service Contract caused by any willful or negligent act, error or omission by the City, its officials, agents, employees, representatives, independent contractors or subcontractors of any tier; (2) the untruth of any material representation made by the City under the City Lease or any material breach, failure, nonperformance or noncompliance by the City with its obligations under the City Lease caused by any willful or negligent act, error or omission by the City, its officials, agents, employees, representatives, independent contractors or subcontractors of any tier.

“City Lease” means that lease executed between the City and PMA which gives PMA the real property rights needed for it to have the legal capacity and authority to enter into the Lease with the Company. The City Lease is appended hereto as a Transaction Agreement.

"Class A Facilities" means the facilities located at the BRC Site that PMA has caused Company to design, permit, finance, construct, own, and operate and are reserved for the exclusive processing of City Biosolids into Class A Product.

"Class A Facilities Obligations" means any loan, note, bond, indenture, or other obligation or instrument of indebtedness issued or incurred by the Company relative to the Service Agreement or the Service Contract.

“Class A Facility Nonperformance Credit” means the credit due to the City as set forth in Section 8.4.C. and Section 8.3. B.(6)(b).

"Class A Period" means the period from the ATSA Date until expiration or termination of this Service Agreement, which generally is the period during which the Class A Facilities provided by the Company on behalf of PMA will process City Biosolids consistent with Section 8.1 B.

"Class A Product" means the material generated through processing of City Biosolids which meet characteristics (i)-(iv) set forth in part (b) of the definition of Conforming City Biosolids, through use of the Operated Facilities, that meets (i) the requirements for Beneficial Use as set forth in 40 CFR 503, and (ii) the standards for Class A pathogen reduction and vector attraction reduction and Table 3 Pollution Concentrations as set forth in 40 CFR 503.

"Class A Service Fee" means the compensation paid by the City to PMA during the Class A Period and each of the components thereof, set forth in Section 8.3 B.

“Class B Biosolids” means biosolids dewatered by the City and left on the BRC Site as of the Commencement Date which meet characteristics (i), (ii) and (iv) set forth in part (a) of the definition of Conforming City Biosolids.

"Class B Product" means Dewatered City Biosolids generated through processing of City Biosolids which meet characteristics (i)-(iv) set forth in part (a) of the definition of Conforming City Biosolids.

"Commencement Date" means the first date on which all the Commencement Date Conditions shall be satisfied, or waived by City, and PMA causes the the Company to begin performance of the Biosolids Services.

"Commencement Date Conditions" has the meaning set forth in Article III.

"Company" means Philadelphia Biosolids Services, LLC, a Subcontractor to PMA through the Service Agreement.

"Company Financing Entity" means a bankruptcy remote or other project specific entity which may be created by or at the direction of Company or Guarantor for the purpose of (i) borrowing tax exempt bond funds to be transferred to Company and used for the Project Financing and (ii) owning the Company-owned Operated Facilities in order to lease them to Company and (iii) serving as sublessee of the Lease in order to sub-sublease the Leased Premises to Company, all such that PMA can fulfill its obligations under this Service Contract.

"Company Fault" means any one or more of the following: (1) the untruth of any material representation made by Company under the Service Agreement, or the Company Financing Entity under any Transaction Agreement to which it is a party or any material breach, failure, nonperformance or noncompliance by Company under the Service Agreement or the Company Financing Entity with its obligations under any Transaction Agreement to which it is a party caused by any willful or negligent act, error or omission by Company or the Company Financing Entity, its officials, agents, employees, representatives, independent contractors or subcontractors of any tier; (2) the untruth of any material representation made by Company under the Lease or any material breach, failure, nonperformance or noncompliance by Company with its obligations under the Lease caused by any willful or negligent act, error or omission by Company its officials, agents, employees, representatives, independent contractors or subcontractors of any tier.

"Company's Guarantor" means Synagro Technologies, Inc. and any successor as provided by the Guaranty attached hereto.

"Conforming City Biosolids" means biosolids that meet the following applicable standards:

(a) During the Interim Period, City Biosolids that (i) are anaerobically digested; and (ii) that meet the standards in 40 CFR § 503 for Class B for pathogen reduction and vector attraction reduction and Table 1 Pollution Concentrations; and (iii) which have a total solids content no less than 1.5% and no more than 6%; and (iv) are not Hazardous Waste, and (v) do not exceed 70,000 Dry Tons Per Contract Year;

(b) During the Class A Period, City Biosolids that (i) are anaerobically digested; and (ii) meet the standards in 40 CFR § 503 for Class B for pathogen reduction and vector attraction reduction and the Table 3 Pollution Concentrations; and (iii) which have a total solids content no less than 1.5% and no more than 6%; and (iv) are not Hazardous Waste; and (v) do not exceed 70,000 Dry Tons Per Contract Year.

City-PMA Service Contract

"Construction Date" means the date set forth in Section 6.2 (C).

"Construction Performance Bond" means the surety bond required under this Service Contract for PMA Subcontractors performing Construction Work at the BRC Site. The surety bond shall provide that both the Company and PMA are obligees in the event of nonperformance by a Subcontractor. The form of the Construction Performance Bond is appended hereto as a Transaction Agreement Form.

"Construction Superintendent" has the meaning specified in subsection 6.4 B.

"Construction Work" means the work required for the construction of improvements to the Existing Facilities and for the construction of the Class A Facilities to be furnished by the PMA pursuant to this Service Contract.

"Consumables" means fuel oil, diesel fuel, natural gas, liquid defoamant, quick lime, lubricants, polymers, office supplies and other chemicals, fuels, materials, supplies and similar consumables used in connection with the Biosolids Services.

"Consumer Price Index" means the final reported non-seasonably adjusted Consumer Price Index for All Urban Consumers for the Northeast United States, published by The United States Department of Labor, Bureau of Labor Statistics (# CUUR0100SAO).

"Contract Representative" shall have the meaning set forth in Section 9.3.

"Contract Standards" means the standards, terms, conditions, methods, techniques and practices imposed or required by: (1) Applicable Law; (2) the Design Requirements; (3) the Performance Standards and Guarantees; (4) Good Engineering and Construction Practice; (5) Good Industry Practice; (6) the Operation and Maintenance Manual; (7) the Operated Facilities Plans; (8) Operation and Maintenance Requirements; (9) applicable equipment manufacturers' specifications; and (10) any other standard, specifically provided in this Service Agreement (including the Appendices) to be observed by PMA and its Subcontractors. Subsection 1.2 N shall govern issues of interpretation related to the applicability and stringency of the Contract Standards.

"Contract Year" means the City's fiscal year.

"Cost Substantiation" means, with respect to any cost reasonably incurred or to be incurred by PMA directly or indirectly chargeable in whole or in part to the City, PMA shall cause the delivery to PMA and the City of a certificate signed by an authorized officer of the Company, setting forth the amount of such cost and the provisions of this Service Contract under which such cost is properly chargeable to the City, accompanied by copies of such documentation requested by the City to reasonably demonstrate that the cost has been or will be paid or incurred.

City-PMA Service Contract

"Design/Build Work" means the Design Work and the Construction Work. A reference to "Design/Build Work" shall mean "any part and all of the Design Work and Construction Work" unless the context otherwise requires.

"Design Work" means the services and work required for the design of the Class A Facilities that PMA shall cause the Company to furnish pursuant to this Service Contract.

"Design Requirements" means the requirements for the design of the Class A Facilities set forth in Appendices 2, 3 and 5.

"Dewatered City Biosolids" means City Biosolids after dewatering through the use of Existing Facilities.

"Digester Gas" means methane-containing gas generated by sludge digesters located at City's Southwest Water Pollution Control Plant and available for use by the Company as fuel for the operation of thermal drying Class A Facilities at the BRC Site. For the purposes of this Service Contract, Digester Gas contains 500 BTUs per cubic foot.

"Dry Ton" means the volume of material that weighs 2,000 pounds after the removal of all moisture.

"Encumbrances" means any Lien, lease, mortgage, security interest, charge, judgment, judicial award, attachment or encumbrance of any kind with respect to the Operated Facilities, other than Permitted Encumbrances.

"Event of Default" means, with respect to PMA, those items specified in Section 10.2 hereof and with respect to the City, those items specified in Section 10.3.

"Excess Unscreened Compost" means all Unscreened Compost left on the BRC Site by the City as of the Commencement Date in excess of 55,000 Wet Tons.

"Existing Facilities" means the buildings, equipment, structures, and other facilities and improvements at the BRC Site in existence and leased to PMA by the City on the Service Contract Date in the condition as set forth in this Service Contract.

"Facility Manager" has the meaning specified in Section 9.1.

"Final Completion" has the meaning specified in Section 6.20.

"Finance Plan" means the plan for providing the capital funds for the Class A Facilities, and any other costs directly or indirectly related thereto, as such plan is developed in accordance with Section 5.2 and Appendix 11.

"Financial Close Date" means the day that the PMA causes the Company to demonstrate to the City that all necessary permanent financing has been arranged to pay the costs of the Design/Build Work and related capital costs of the Company for the Class A Facilities and that

City-PMA Service Contract

any pre-conditions for the actual disbursement of funds can be met by the Company in the ordinary course of business and are acceptable to City.

"Financing Documents" means all documents between or among the Company, the Lender, and other entities related to the Class A Facilities Obligations.

"Fixed Capacity Charge" means the component of the Class A Service Fee that compensates the PMA for the annual debt service obligations and Additional Capital associated with providing the improvements to Existing Facilities and the Class A Facilities for the exclusive processing of City Biosolids.

"Fixed Operating Charge" means the component of the Class A Service Fee that compensates PMA for the dewatering and processing and other services and related costs of operations, maintenance, transportation, disposal, and utilization associated with providing the Biosolids Services that do not vary significantly with the quantity of City Biosolids.

"Good Engineering and Construction Practice" means those methods, techniques, standards and practices which, at the time they are to be employed and in light of the circumstances known or reasonably believed to exist at such time, are generally recognized and accepted as good design, engineering, equipping, installation, construction and commissioning practices for the design, construction and improvement of capital assets in the municipal wastewater treatment industry as followed in the Mid-Atlantic region of the United States.

"Good Industry Practice" means those methods, techniques, standards and practices which, at the time they are to be employed and in light of the circumstances known or reasonably believed to exist at such time, are generally recognized and accepted as good operation, maintenance, repair, replacement and management practices in the biosolids industry as followed in the Mid-Atlantic region of the United States.

"Government Approval" means a permit, license, approval, authorization, consent or entitlement of whatever kind and however described which is required under Applicable Law or by a Government Body to be obtained or maintained by any person with respect to the Biosolids Services, including the Operated Facilities construction or operation.

"Governmental Body" means any federal, State, County, City, local or regional legislative, executive, judicial or other governmental board, agency, authority, commission, administration, court or other body.

"GPD" means Gallons Per Day.

"Guaranty Agreement" means the Guaranty Agreement executed by Synagro Technologies, Inc. on behalf of PMA. The Guaranty Agreement is appended hereto as a Transaction Agreement.

"Hazardous Substance" means (i) asbestos, flammables, volatile hydrocarbons, industrial solvents, explosives, hazardous chemicals, radioactive material, oil, petroleum, petroleum

products or by products, crude oil, natural gas, natural gas liquids, hazardous chemical gases and liquids, volatile or highly volatile liquids, and/or synthetic gas, and shall include, without limitation, substances defined as "hazardous substances," "hazardous materials," "hazardous waste," "toxic substances," "pollutants," or "contaminants," as those terms are used in any environmental law or at common law; and (ii) any and all other materials or substances that any governmental agency or unit having appropriate jurisdiction shall determine in generally applicable regulations from time to time are hazardous, harmful, toxic, dangerous or otherwise required to be removed, cleaned-up, or remediated.

"Hazardous Waste" means (i) any Hazardous Substance; or (ii) any waste which by reason of its quality, concentration, composition or physical, chemical or infectious characteristics is known to do any of the following: cause, or significantly contribute to, an increase in mortality or an increase in serious irreversible, or incapacitating reversible, illness, or pose a substantial threat or potential hazard to human health or the environment when improperly treated, stored, transported or disposed of or otherwise mismanaged, or any waste which is defined or regulated as a hazardous waste, toxic substance, hazardous chemical substance or mixture, or asbestos under Applicable Law, as amended from time to time.

"Initial Term" has the meaning set forth in Section 11.1.

"Insurance Requirement" means any rule, regulation, code, or requirement issued by any fire insurance rating bureau or any body having similar functions or by any insurance company which has issued a policy of Required Insurance under this Service Contract, as in effect during the Term, compliance with which is a condition to the effectiveness of such policy.

"Interim Period" means the period from the Commencement Date until the ATSA Date.

"Interim Service Fee" means the compensation paid by the City to PMA during the Interim Period and each of the components thereof, as set forth in Section 8.2.

"Labor and Materials Payment Bond" means a dual-obligee bond which guarantees the timely payment for all labor, materials, supplies, and machinery and equipment to be furnished with respect to the improvement of the Existing Facilities and the construction of the Class A Facilities. The form for the Labor and Materials Payment Bond appended hereto as a Transaction Agreement Form.

"Lease" means the lease between PMA and the Company providing for the use and possession of the Leased Premises. The Lease is appended hereto as a Transaction Agreement.

"Leased Premises" means the land and Existing Facilities leased to PMA by the City under the City Lease and to Company by PMA under the Lease for its use in providing the Biosolids Services.

"Leasehold Mortgage" means a mortgage, deed of trust or security agreement given in respect of real or personal property to a Lender as collateral security for the Class A Facilities Obligations.

City-PMA Service Contract

"Legal Proceeding" means every action, suit, litigation, administrative proceeding, and other legal or equitable proceeding arising out of the obligations of the parties under this Service Contract.

"Lender" means a holder, directly or indirectly, of Class A Facilities Obligations or a Leasehold Mortgage including, without limitation, a bank or other financial institution, a bond insurance firm, or a bond trustee, and any agent, trustee, or other legal representative of such holder for such purposes.

"Lien" means any and every lien against the Operated Facilities or the BRC Site or against any monies due or to become due from the City to PMA under this Service Contract, for or on account of the Design/Build Work or the Biosolids Services, including without limitation mechanics', materialmen's, laborers' and lenders' liens.

"Liquidated Damages" means the monetary payments made to the City by PMA for failure to comply with certain contractual obligations as more specifically set forth in this Service Contract.

"Loss-and-Expense" means and is limited to any and all actual loss, liability, forfeiture, obligation, damage, delay, penalty, judgment, cost, or expense, including all reasonable fees and expenses of attorneys, expert witnesses, consultants and other persons, and costs of transcripts, printing of briefs and records on appeal, copying and other reimbursed expenses, and expenses reasonably incurred in connection with any Legal Proceeding, except as excluded by this Service Contract.

"Maintenance Plan" means the plan for maintenance renewal, replacement and repair of the Existing Facilities and the Class A Facilities as set forth in Appendices 1 and 8.

"Marketing Plan" has the meaning set forth in Section 7.5 A.

"Maximum Alternative Fuel Guarantee" means 85 Therms of Alternative Fuel consumption per Dry Ton of Dewatered City Biosolids processed into Class A Product for all facilities and activities of the Company at the BRC Site during the Class A Period, including operation of the Existing Facilities and the Class A Facilities

“Maximum Electrical Power Guarantee” means 375 kilo-watt hours of electrical power consumption per Dry Ton of Dewatered City Biosolids processed into Class A Product for all facilities and activities of the Company at the BRC Site during the Class A Period, including operation of the Existing Facilities and the Class A Facilities.

“Maximum Natural Gas Guarantee” means 85 Therms of natural gas consumption per Dry Ton of Dewatered City Biosolids processed into Class A Product for all facilities and activities of the Company at the BRC Site during the Class A Period, including operation of the Existing Facilities and the Class A Facilities.

“MGD” means Million Gallons per Day.

"Monthly Reports" means the reports listed in Appendices 1, 2, 3, and 8.

“Nonconforming Class B Biosolids” means biosolids dewatered by the City and left on the BRC Site on the Service Contract Date which do not meet characteristics (i), (ii) and (iv) set forth in part (a) of the definition of Conforming City Biosolids.

"Nonconforming City Biosolids" means biosolids delivered by the City to the BRC Site that are not Conforming Biosolids.

“NEWPCP” means the City’s Northeast Water Pollution Control Plant

"Operated Facilities" means the Existing Facilities during the Interim Period and, after the ATSA Date, the Existing Facilities and the Class A Facilities.

"Operated Facilities Plans" shall mean all plans included in Appendices 1 and 8.

"Operation and Maintenance Manual" has the meaning set forth in Section 4.3.

"Operation and Maintenance Requirements" means the requirements for operation and maintenance set forth in Appendices 1 and 8.

"Performance Guarantees" means the measurable, technical obligations of PMA through its Service Agreement with the Company as set forth in Section 7.3 of Appendix 7, that must be met throughout the Term (or for the portions of the Term which are specified in Section 7.3 of Appendix 7) by the Company in the performance of the Biosolids Services.

"Performance Standards" means the general work and operational standards which must be met throughout the Term by the Company on behalf of PMA in the performance of the Biosolids Services, as set forth in Section 7.1 of Appendix 7.

"Permitted Encumbrances" means, as of any particular time, any one or more of the following: (1) Class A Facilities Obligations; (2) encumbrances for utility charges, taxes, rates and assessments not yet delinquent or, if delinquent, the validity of which is being contested diligently and in good faith by the Company and against which the Company has established appropriate reserves in accordance with GAAP; (3) any encumbrance arising out of any

judgment rendered which is being contested diligently and in good faith by the Company, the execution of which has been stayed or against which a bond or bonds in the aggregate principal amount equal to such judgments shall have been posted with a financially sound insurer and which does not have a material adverse effect on the ability of the Company to operate its business or operations; (4) zoning and building bylaws and ordinances, municipal bylaws and regulations, and restrictive covenants, which do not materially interfere with the use of the Operated Facilities by the Company as the Operated Facilities are used; or (5) any indebtedness permitted to be secured by the Operated Facilities or any part thereof pursuant to Section 5.2.

"PMA" means The Philadelphia Municipal Authority, a body corporate and politic of the Commonwealth of Pennsylvania.

"PMA Fault" means any one or more of the following: (1) the untruth of any material representation made by PMA under this Service Contract or any material breach, failure, nonperformance or noncompliance by PMA with its obligations under this Service Contract caused by any willful or negligent act, error or omission by PMA, its officials, agents, employees, representatives, independent contractors or subcontractors of any tier; (2) the untruth of any material representation made by PMA under the City Lease or any material breach, failure, nonperformance or noncompliance by PMA with its obligations under the City Lease caused by any willful or negligent act, error or omission by PMA, its officials, agents, employees, representatives, independent contractors or subcontractors of any tier; (3) if adversely affecting the rights or obligations of the City under the Service Contract, the untruth of any material representation made by PMA or the Company under the Service Agreement or any material breach, failure, nonperformance or noncompliance by PMA or the Company with its obligations under the Service Agreement caused by any willful or negligent act, error or omission by PMA or the City, its officials, agents, employees, representatives, independent contractors or subcontractors of any tier; (4) if adversely affecting the rights or obligations of the City under the Service Contract or City Lease, the untruth of any material representation made by PMA or the Company under the Lease or any material breach, failure, nonperformance or noncompliance by PMA or the Company with its obligations under the Lease caused by any willful or negligent act, error or omission by PMA or the Company, its officials, agents, employees, representatives, independent contractors or subcontractors of any tier.

"Processing Efficiency Incentive" means the component of the Class A Service Fee intended to provide a financial incentive for efficient operation of Class A Facilities, as more fully described in Section 8.3B.(7).

"Product" means Class A Product and/or Class B Product.

"Project Financing" means an amount determined by taking the Fixed Design/Build Price minus Additional Capital, which amount shall be financed by the Company via a borrowing from a third party.

"Project Schedule" means the schedule for implementation of the Biosolids Services, including the permitting, design, financing, construction, and testing of the Class A Facilities, as

City-PMA Service Contract

set forth in Appendix 4, as shall be provided by PMA in more detail for the Construction Work on or before the Construction Date.

"Quality Assurance/Quality Control" or "QA/QC" means the procedures and practices to be employed by the Company to promote its performance of the Biosolids Services in accordance with the applicable standards of quality.

"Reimbursable Costs" means those costs incurred by PMA in providing the Biosolids Services under certain circumstances (including Nonconforming City Biosolids and Uncontrollable Circumstances) that are reimbursable by the City as a component of the Interim Service Fee and the Service Fee as set forth in Section 8.5.

"Reimbursable Expenses" means the reasonable and necessary costs incurred by the PMA for Biosolids Services and paid to third parties from the Commencement Date to the date of termination by the City under Section 8.3 B.

"Renewal and Replacement" means the obligation that PMA has undertaken throughout the term for renewal and replacement of the Existing Facilities and for the Class A Facilities as set forth in the Contract Standards including Appendices 1 and 8.

"Required Insurance" means the minimum coverage of insurance that is required to be provided by the PMA or its Subcontractors during the Interim Period and the Class A Period as set forth in Appendix 12.

"RFP" has the meaning set forth in the recitals hereto.

"Safety Program" means the safety program developed during the Transition Period in accordance with Appendix 1 and maintained throughout the Term.

"Service Agreement" means this Biosolids Recycling Center Operation Service Agreement between the Company and PMA, including the Appendices, Transaction Agreements and Transaction Agreement Forms appended hereto, as amended or modified.

"Service Contract" means this Biosolids Recycling Center Operation Service Contract between the City and PMA, including the Appendices, Transaction Agreements and Transaction Agreement Forms appended thereto, as amended or modified. The Service Agreement is appended hereto as a Transaction Agreement.

"Service Contract Date" means the date of this Service Contract has been executed and delivered.

"Service Contract Performance Bond" has the meaning set forth in Section 12.2(B)(1). The form for the Service Agreement Performance Bond is appended hereto as a Transaction Agreement Form.

"Service Fee" means the Interim Service Fee and the Class A Service Fee and each of the components thereof.

City-PMA Service Contract

"SEWPCP" means the City's Southeast Water Pollution Control Plant.

"State" means the Commonwealth of Pennsylvania.

"Subcontract" means an agreement between PMA and a Subcontractor including the Service Agreement.

"Subcontractor" means every person (other than employees of PMA) employed or engaged by PMA at any tier for any portion of the Design/Build Work or Biosolids Services, whether for the furnishing of labor, materials, equipment, supplies, services, or otherwise.

"SWWPCP" means the City's Southwest Water Pollution Control Plant.

"Term" has the meaning set forth in Section 11.1.

"Termination Date" has the meaning set forth in Section 11.1.

"Therm" means the unit of measurement equal to 100,000 BTUs of heat value and upon which the price of natural gas or other fuel is based.

"Training Plan" means the plan for initial and periodic training of Company, Subcontractor, PMA and City personnel as set forth in a plan prepared by Company and approved by City prior to the Commencement Date.

"Transaction Agreement" means an executed agreement appended to the Service Contract or the Service Agreement that materially affects the rights or obligations of the parties to the Service Agreement or this Service Contract.

"Transaction Agreement Form" means an agreed form of an agreement which is intended to become a Transaction Agreement when executed, but which is unexecuted on the Service Contract Date.

"Transition Period" means the period of time from the Service Contract Date to the Commencement Date.

"Uncontrollable Circumstances" means an event or circumstance, or combination of events and circumstances, making the performance of an obligation impossible, more costly, or more time-consuming that is outside the reasonable control of a party and not the result of a failure of such party to apply reasonable diligence. Subject to the foregoing, but not limiting its generality, each of the following is an Uncontrollable Circumstance: (a) a Change in Law except as excluded in the definition of Change in Law, but including any air permit requirement necessary for the Biosolids Services, which classifies the BRC emissions for VOC and NOx greater than the regulatory threshold to be considered a Major Stationary Source (in excess of twenty five (25) Tons per year each) or any permit requirement, which is beyond Best Available Control Technology (BACT) for similar Andritz facilities installed within two years prior to the Service Agreement Date; (b) naturally occurring events (excluding normal weather conditions for the location affected) such as landslides, underground movement, earthquakes,

City-PMA Service Contract

lightning, fire, tornadoes, hurricanes, floods, epidemics, and other acts of God; (c) labor disputes, except labor disputes involving only employees of PMA, the Company, its affiliates, or Subcontractors; (d) failure of utility service provided by a third party; (e) public emergency; (f) presence of Hazardous Substances or Hazardous Wastes at the BRC Site not caused by PMA or its Subcontractors; (g) sabotage, acts of a declared public enemy or terrorist, extortion, war, blockage, insurrection, riot, or civil disturbance; (h) suspension, termination, interruption, delay in issuance or delay in renewal of any Governmental Approval; (j) condemnation or other taking by eminent domain; (k) subject to Section 6.1, soil conditions that materially differ from those reasonably anticipated by PMA .

Under no condition do any of the following constitute an Uncontrollable Circumstance: (i) changes in economic conditions, market conditions, interest rates, inflation rates, wage rates, commodity prices, currency values, or exchange rates; (ii) changes in financial condition; (iii) union or labor work rules, requirements or demands; (iv) changes in taxes or rates (except for City taxes); (v) failure to obtain any patent, license, or rights to use intellectual property; (vi) with regard to Product utilization, transportation, storage or disposal: (a) during the Interim Period, a change in local, county, regional or other Applicable Law, except applicable federal law and state law in Pennsylvania, Maryland and Virginia; and (b) during the Class A Period, a change in local, county, regional or other Applicable Law, except applicable federal law and state law in Pennsylvania; and (vii) failure of equipment, unless caused by an Uncontrollable Circumstance.

“Unscreened Compost” means all Unscreened Compost left on the BRC Site by the City as of the Commencement Date up to 55,000 Wet Tons.

"Utilities" means any and all utility services and installations whatsoever (including gas, water, sewer, electricity, telephone, and telecommunications), and all piping, wiring, conduit, and other fixtures of every kind whatsoever related thereto or used in connection therewith.

"Variable Processing Charge" means the component of the Class A Service Fee that compensates the PMA for the costs that vary with the quantity of Dewatered City Biosolids processed via the Class A Facilities.

“Wet Ton” means 2,000 pounds.

1.2 Interpretation. In this Service Contract, unless the context otherwise requires:

A. References Hereto. The terms "hereby," "hereof," "herein," "hereunder" and any similar terms refer to this Service Contract; and the term "hereafter" means after, and the term "heretofore" means before, the Service Contract Date.

B. Gender and Plurality. Words of the masculine gender mean and include correlative words of the feminine and neuter genders and words importing the singular number mean and include the plural number and vice versa.

- C. Persons. Words importing persons include firms, companies, associations, joint ventures, general partnerships, limited partnerships, limited liability corporations, trusts, business trusts, corporations and other legal entities, including public bodies, as well as individuals.
- D. Headings. The table of contents and any headings preceding the text of the Articles, Sections and subsections of this Service Contract shall be solely for convenience of reference and shall not affect its meaning, construction or effect.
- E. References to Days. All references to days herein are references to calendar days.
- F. References to Including. All references to "including" herein shall be interpreted as meaning "including without limitation."
- G. References to Knowledge. All references to "acknowledge," "knowing," "know" or "knew" shall be interpreted as references to a party having actual knowledge.
- H. References to Consent or Approval. Unless a reasonableness standard is expressly removed by the language of a section in this Service Contract, all references herein in which a party has the right to consent to or approve any action by the other party or by a third party shall be deemed to state and shall be interpreted such that such consent or approval "shall not be unreasonably withheld."
- I. Counterparts. This Service Contract may be executed in any number of original counterparts. All such counterparts shall constitute but one and the same Service Contract.
- J. Governing Law. This Service Contract shall be governed by and construed in accordance with the applicable laws of the State.
- K. Defined Terms. The definitions set forth in Section 1.1 shall control in the event of any conflict with any definitions used in the recitals.
- L. Liquidated Damages. This Service Contract provides for the payment by PMA of liquidated damages in certain circumstances of non-performance, breach and default. Each party agrees that the City's actual damages in each such circumstance would be difficult or impossible to ascertain (particularly with respect to the public harm that would occur as a result of such non-performance, breach or default of PMA), and that the liquidated damages provided for herein with respect to each such circumstance are intended to place the City in the same economic position as it would have been in had the circumstance not occurred. Except where additional remedies are otherwise specifically provided for herein, such liquidated damages shall constitute the only damages payable by PMA to the City in such circumstances of non-performance, breach or default, regardless of legal theory.
- M. Assistance. The obligations of a party to cooperate with, to assist or to provide assistance to the other party hereunder shall be construed as an obligation to use the party's personnel resources to the extent reasonably available in the context of performance of their normal duties,

and not to incur material additional overtime or third-party expense unless requested and reimbursed by the assisted party.

N. Technical Standards and Codes. References in this Service Contract to all professional and technical standards, codes and specifications are to the most recently published professional and technical standards, codes and specifications of the institute, organization, association, authority or society specified, all as in effect as of the Service Contract Date. Unless otherwise specified to the contrary, (1) all such professional and technical standards, codes and specifications shall apply as if incorporated in the Design Requirements and (2) if any material revision occurs, to PMA's knowledge, after the Service Contract Date, and prior to completion of the applicable Design/Build Work, PMA shall notify the City. If so directed by the City, PMA shall perform the applicable Design/Build Work in accordance with the revised professional and technical standard, code, or specification as long as PMA is compensated, subject to Cost Substantiation, for any additional cost or expense attributable to any such revision.

O. Applicability and Stringency of Contract Standards. PMA shall be obligated to comply only with those Contract Standards which are applicable in any particular case. Where more than one Contract Standard applies to any particular performance obligation of PMA hereunder, each such applicable Contract Standard shall be complied with. In the event there are different levels of stringency among such applicable Contract Standards, the most stringent of the applicable Contract Standards shall govern.

P. Causing Performance. A party shall itself perform, or shall cause to be performed, subject to any limitations specifically imposed hereby with respect to Subcontractors or otherwise, the obligations affirmatively undertaken by such party under this Service Contract.

Q. Party Bearing Cost of Performance. All obligations undertaken by each party hereto shall be performed at the cost of the party undertaking the obligation or responsibility, unless the other party has explicitly agreed herein to bear all or a portion of the cost either directly, by reimbursement to the other party; or through an adjustment to the Service Fee.

R. Cost of Performing Excludes Cost from Legal Proceeding. The "cost of performing" a party's obligations hereunder, when used with respect to one party's obligation to pay additional costs incurred by the other party, shall not include any Loss-and-Expense incurred by the party resulting from any third-party Legal Proceeding. Notwithstanding the foregoing, each party retains its rights to bring any Legal Proceeding or to implead the other party as to any matter arising hereunder.

S. Entire Agreement. This Service Contract contains the entire agreement between the parties hereto with respect to the transactions contemplated by this Service Contract and nothing in this Service Contract is intended to confer on any person other than the parties hereto and their respective permitted successors and assigns hereunder any rights or remedies under or by reason of this Service Contract. Without limiting the generality of the foregoing, this Service Contract shall completely and fully supersede all other understandings and agreements among the parties

City-PMA Service Contract

with respect to such transactions, including those contained in the RFP, the proposal submitted in response thereto, and any amendments or supplements to such request or to such proposal.

T. Severability. If any clause, provision, subsection, Section or Article of this Service Contract shall be ruled invalid by any court of competent jurisdiction, then the parties shall: (1) promptly meet and negotiate a substitute for such clause, provision, subsection, Section or Article which shall, to the greatest extent legally permissible, effect the intent of the parties therein; (2) if necessary or desirable to accomplish item (1) above, apply to the court having declared such invalidity for a judicial construction of the invalidated portion of this Service Contract; and (3) negotiate such changes in, substitutions for or additions to the remaining provisions of this Service Contract as may be necessary in addition to and in conjunction with items (1) and (2) above to effect the intent of the parties in the invalid provision. The invalidity of such clause, provision, subsection, Section or Article shall not affect any of the remaining provisions hereof, and this Service Contract shall be construed and enforced as if such invalid portion did not exist.

U. Time is of the Essence. Time is of the essence with regard to the City and PMA performance of their respective obligations under this Service Contract.

ARTICLE 2

REPRESENTATIONS AND WARRANTIES

2.1 Representations and Warranties of PMA. PMA represents and warrants that:

A. Existence and Powers. PMA is a body corporate and politic, validly existing under the Constitution and laws of the Commonwealth of Pennsylvania with full legal right, power and authority to enter into and perform the obligations under this Service Contract.

B. Due Authorization and Binding Obligation. PMA has duly authorized the execution and delivery of this Service Contract. This Service Contract has been duly executed and delivered by PMA and constitutes a legal, valid and binding obligation of PMA.

C. No Conflict. Neither the execution nor the delivery by PMA of this Service Contract nor the performance by PMA of its obligations hereunder nor the consummation by PMA of the transactions contemplated hereby (1) conflicts with, violates or results in a breach of any Applicable Law or (2) conflicts with, violates or results in a breach of any term or condition of any judgment, decree, agreement or instrument to which PMA is a party or by which PMA or any of its properties or assets are bound, or constitutes a default thereunder.

D. Service Agreement. (1) PMA and the Company will execute the Service Agreement. PMA and the Company are duly authorized to execute and deliver the Service Agreement. The Service Agreement will constitute a legal, valid and binding obligation of PMA and the Company, enforceable against PMA or the Company in accordance with its terms except insofar as such enforcement may be affected by bankruptcy, insolvency, moratorium and other laws affecting creditors' rights generally; and (2) the City was allowed to review and approve the form of the Service Agreement prior to its execution, in the form executed by PMA and the Company; and (3) PMA shall not agree to an amendment of the Service Agreement that shall adversely affect the City or the Service Contract and PMA shall notify the City in advance of any proposed amendment to the Service Agreement. E. Lease. (1) PMA and the Company will execute the Lease. PMA and the Company were duly authorized to execute and deliver the Lease. The Lease constitutes a legal, valid and binding obligation of PMA and the Company, enforceable against PMA or the Company in accordance with its terms except insofar as such enforcement may be affected by bankruptcy, insolvency, moratorium and other laws affecting creditors' rights generally; and (2) the City was allowed to review and approve the form of the Lease prior to its execution, in the form executed by PMA and the Company; and (3) PMA shall not agree to an amendment of the Lease that shall adversely affect the City, the Service Contract or the City Lease and PMA shall notify the City in advance of any proposed amendment to the Lease.

F. No Litigation. There is no action, suit or other proceeding as of the Service Contract Date, at law or in equity, before or by any court or governmental authority, pending or, to the PMA's best knowledge, threatened against the PMA or the Company which is likely to result in an unfavorable decision, ruling or finding which would materially and adversely affect the execution or delivery of this Service Contract or the validity or enforceability of this Service

City-PMA Service Contract

Contract or any other agreement or instrument entered into by the PMA in connection with the transactions contemplated hereby.

2.2 Representations and Warranties of the City. The City hereby represents and warrants that:

A. Existence and Powers. The City is a body corporate and politic validly existing under the Constitution and laws of the Commonwealth of Pennsylvania with full legal right, power and authority to enter into and perform its obligations under this Service Contract.

B. Due Authorization and Binding Obligation. The City has duly authorized the execution and delivery of this Service Contract and this Service Contract has been duly executed and delivered by it and constitutes a legal, valid and binding obligation of City, enforceable against City in accordance with its terms.

C. No Conflict. Neither the execution nor the delivery by it of this Agreement, nor its performance of its obligations in connection with the transactions contemplated hereby nor its fulfillment of the terms or conditions hereof (1) conflicts with, violates or results in a breach of any Applicable Laws, or (2) conflicts with, violates or results in a breach of any term or condition of any judgment or decree, or any agreement or instrument, to which City is a party or by which City or any of its properties or assets are bound, or constitutes a default thereunder.

D. No Litigation. There is no action, suit or other proceeding as of the Service Contract Date, at law or in equity, before or by any court or governmental authority, pending or, to the City's best knowledge, threatened against the City which is likely to result in an unfavorable decision, ruling or finding which would materially and adversely affect the execution or delivery of this Service Contract or the validity or enforceability of this Service Contract or any other agreement or instrument entered into by the City in connection with the transactions contemplated hereby.

E. No Legal Prohibition. The City has no knowledge of any Applicable Law in effect on the date as of which this representation is being made which would prohibit the performance by the Company of this Service Contract and the transactions contemplated hereby.

ARTICLE 3

TRANSITION TO OPERATION OF EXISTING FACILITIES

3.1 Commencement Date Conditions

The obligations of the City and PMA to proceed with their respective obligations during the Interim Period shall not commence until all of the following conditions below (the "Commencement Date Conditions") are satisfied or waived by both parties.

3.2 PMA Commencement Date Conditions.

A. Obligation to Proceed. Promptly following the Service Contract Date, and conditioned upon City's completion of its Commencement Date Conditions as set forth in Section 3.3, PMA shall cause the Company to satisfy the following conditions prior to the Commencement Date.

- (1) Transition Plan. In accordance with Appendix 1, develop and obtain City's written approval of the Transition Plan which shall: (a) outline the orderly transfer of management responsibility for the Existing Facilities from City to PMA and thereafter to Company in accordance with Appendix 1, and (b) outline all management, technical, administrative, engineering, labor relations and other personnel necessary in connection therewith.
- (2) Implementation of Transition Plan. Carry out and perform any aspect of the Transition Plan which is specified to be completed by Company prior to the Commencement Date, including those items specified in Sections 1.1 and 1.4 of Appendix 1.
- (3) Appointments. Appoint a Facility Manager according to Section 9.1 and a Contract Representative according to Section 9.3 A.
- (4) Company Performance Security. Provide (a) the Service Contract Performance Bond in accordance with Section 12.2 B.(1) substantially in the form set out in the Transaction Agreement Forms and (b) the Guaranty Agreement.
- (5) Required Insurance. Provide the Required Insurance for the Interim Period as set forth in Appendix 12.
- (6) Financial Condition. Provide audited financial statements of the Company's Guarantor for the most recently completed fiscal year and quarterly period which the Company is required to maintain under Section 12.2.
- (7) Execution of Lease. Have executed and delivered the Lease.

City-PMA Service Contract

(8) Legal Proceedings. Confirm that there are no Legal Proceedings against the Company or the Company's Guarantor, at law or in equity, before or by any court or governmental authority, pending or threatened, which (1) challenges, or might challenge, directly or indirectly, (a) the authorization, execution, delivery, validity or enforceability of this Service Contract, the Service Agreement or any other Transaction Agreement entered into or adopted by PMA, the Company or the Company's Guarantor in connection with the transactions contemplated by this Service Contract or (b) the real property interest of the Company in the BRC Site, or (2) seeks to enjoin or restrict the use of the BRC Site for the purposes contemplated by this Service Contract or seeks damages, fines, remediation or any other remedy in connection with the environmental condition or any other factor pertaining to the BRC Site.

(9) Inventory. Conduct an inventory of all vehicles, rolling stock, spare parts and Consumables to be transferred to the PMA on the Commencement Date.

(10) Government Approvals. Obtain a Philadelphia business license.

(11) No Company Fault. No Company Fault shall exist under the Service Agreement as of the anticipated Commencement Date.

B. Execution of City Lease. Have executed and delivered the City Lease.

C. No PMA Fault. No PMA Fault shall exist under the Service Agreement as of the anticipated Commencement Date.

D. Notice of Default. PMA shall provide the City, promptly following the receipt thereof, copies of any notice of default, breach or noncompliance received under or in connection with any Government Approval, Subcontract or other Transaction Agreement pertaining to the Transition Period.

3.3 City Commencement Date Conditions. Following the Service Contract Date and before the Commencement Date the City shall:

A. Lease and Property Description. Furnish the PMA a form of City Lease acceptable to PMA with a property description of the BRC Site.

B. Governmental Approvals. Cooperate with and assist PMA in obtaining all Governmental Approvals which the PMA or its Subcontractors are responsible for obtaining in order to begin the Interim Period services.

C. Access to Existing Facilities. Grant PMA, through the execution of the City Lease, the right of access to the BRC Site for the purposes of performance of the Biosolids Services and through a grant of any other easements, licenses or rights of way over the BRC which PMA has described to the City and which are necessary for PMA to be able to perform the Biosolids Services.

City-PMA Service Contract

D. Transition Plan. (1) Assist PMA and the Company in writing the Transition Plan, or provide information to the Company as needed for the Transition Plan; and (2) carry out and perform any aspect of the Transition Plan which is specified to be completed by the City prior to the Commencement Date, including all items set forth in Section 1.3 of Appendix 1, which includes the demonstration of the capacity of the Existing Facilities.

E. Assign Contracts. Assign to PMA or the Company all City contracts with contractors which are agreed by the parties to be necessary for the Company to perform the Interim Period services on behalf of PMA. The effective date of the assignment shall be the Commencement Date. Such assigned contracts shall be listed on Appendix 15.

F. Appointment. Appoint a Contract Representative according to Section 9.3(A).

G. Legal Proceedings. Confirm that there are no Legal Proceedings against the City, at law or in equity, before or by any court or governmental authority, pending or threatened, which (1) challenges, or might challenge, directly or indirectly, (a) the authorization, execution, delivery, validity or enforceability of this Service Contract or any other Transaction Agreement entered into or adopted by the City in connection with the transactions contemplated by this Service Contract or (b) the real property interest of the City in the BRC Site, or (2) seeks to enjoin or restrict the use of the BRC Site for the purposes contemplated by this Service Contract or seeks damages, fines, remediation or any other remedy in connection with the environmental condition or any other factor pertaining to the BRC Site.

H. No City Fault. No City Fault shall exist under this Service Contract as of the anticipated Commencement Date.

3.4 Closing of the Transition Period.

A. Satisfaction of Commencement Date Conditions. The parties shall notify each other when each Commencement Date Condition has been met. Documents or instruments constituting or evidencing satisfaction of the Commencement Date Conditions shall be delivered to each party prior to or on the anticipated Commencement Date. Upon the satisfaction of all Commencement Date Conditions, the City shall establish a Commencement Date and notify PMA in writing. The parties anticipate that the Commencement Date shall be ninety (90) days following the Service Contract Date.

B. Failure of Commencement Date Conditions. If by one hundred and eighty (180) days from the Service Agreement Date, or such later date upon which the City and PMA may agree in writing, any of the PMA's Commencement Date Conditions, as set forth in Section 3.2 (A), are not satisfied, or have not been waived by the City, and if all the City's Commencement Date Conditions, as set forth in Section 3.3 have been met by the City or have been waived by PMA, the City may, by notice in writing to the Company, terminate this Service Contract; provided, however, that if the failure to meet the Commencement Date Conditions results from a denial of any Governmental Approval that PMA through the Company has elected to appeal, the City may not terminate this Service Contract under this Section unless the Company ceases to diligently pursue the appeal. If the City's termination of this Service Contract under this Section is due to

PMA's failure to satisfy any of the PMA Commencement Date Conditions set forth under Section 3.2 (A) and such failure is not excused by an Uncontrollable Circumstance or City Fault (including City's failure to meet Commencement Date Conditions set forth in Section 3.3), then not later than thirty (30) days after such termination the PMA shall pay liquidated damages to the City in the amount of Two Million Dollars (\$2,000,000). Other than such payment of liquidated damages under this Section by PMA, neither party shall have any further liability to the other in the event of termination by the City under this Section. Specifically, PMA shall not be liable for damages as set forth in Sections 5.6, 6.2 (D) and 6.18(C).

3.5 Termination for Cause During the Transition Period. Section 3.4 B. shall not be construed to prevent either party from exercising its right, prior to the Commencement Date, to terminate this Service Agreement pursuant to Article 10, due to an Event of Default by the other party (other than its failure to comply with Section 3.2 or 3.3, as applicable.) and to pursue all remedies available pursuant to Article 10 upon the occurrence of an Event of Default.

ARTICLE 4

BIOSOLIDS SERVICES

4.1 PMA Operation and Maintenance Obligations.

A. General. Starting on the Commencement Date, PMA shall cause the Company to operate and maintain the Operated Facilities on a continuous basis, and shall accept, dewater, process, utilize or dispose of all City Biosolids received at the BRC, all in accordance with the Operation and Maintenance Manuals, the Performance Standards, the Performance Guarantees and any other standards applicable to such activities and the terms and provisions of this Service Contract.

B. Product and Utilization.

(1) Interim Period. During the Interim Period, PMA shall cause the Company to operate and maintain the Existing Facilities to produce Class B Product from all City Biosolids (unless Nonconforming City Biosolids or Uncontrollable Circumstances prevent the production of Class B Product) and generally utilize Class B Product in accordance with Appendix 1.

(2) Class A Period. During the Class A Period, the PMA shall cause Company to operate the Class A Facilities to produce Class A Product from all City Biosolids (unless Nonconforming City Biosolids or Uncontrollable Circumstances prevent the production of Class A Biosolids) and Company shall put such Class A Product to Beneficial Use and shall implement Product marketing in accordance with Appendix 9, provided that Company may ship offsite up to 4,000 Dry Tons per Contract Year of Class B Product during the Class A Period which is produced by reason of planned or unplanned maintenance, repair and replacement activities or due to emergency. As set forth in Section 8.3, PMA shall provide a Nonperformance Credit to the City for any Class B Product shipped off-site in excess of 4,000 Dry Tons per Contract Year during the Class A Period.

C. Third-Party Biosolids. PMA shall not receive biosolids or any other materials or substances from third parties unless approved in writing by the City pursuant to PMA's written request delivered to the City ninety (90) days in advance of any such proposed third-party services or co-mingling.

4.2 Condition of Existing Facilities.

A. The City shall perform a five (5) day "performance test" or demonstration in accordance with Section 1.3.2 of Appendix 1. City shall be responsible for the costs of improving Existing Facilities so that they are capable of processing 70,000 Dry Tons per year of City Biosolids as set forth in Section 1.3.2 of Appendix 1. The City shall be responsible for any Hazardous Waste or

Substance existing on the BRC Site prior to the Commencement Date and found by PMA or its Subcontractors during operations or construction during the Interim Period and Class A Period.

4.3 Operation and Maintenance.

A. Interim Period. PMA shall cause Company to provide Biosolids Services during the Interim Period in accordance with Appendix 1 and the Contract Standards. Company shall maintain the Existing Facilities in accordance with the Existing Facilities Operations and Maintenance Manual and consistent with industry standards.

B. Computerized Maintenance Management System. Not later than one hundred eighty (180) days after the Commencement Date, PMA shall cause Company, in accordance with Section 1.6 of Appendix 1, to install and maintain a computerized maintenance management system. PMA shall cause the Company to provide the City with documentation which allows it and PMA to efficiently monitor compliance by the Company with its maintenance obligations hereunder. The City shall have computer-based real time, read-only access to such system. The Company shall permit all electronic data to be replicated and provided to the City for review.

C. Class A Period. PMA shall cause the Company to provide Biosolids Services during the Class A Period in accordance with Appendices 2, 3, 7, 8 and 9 and the Contract Standards. Company shall operate and maintain the Operated Facilities in accordance with Appendices 2 and 8 and the Contract Standards. PMA shall cause the Company to provide a Operation and Maintenance Manual for the Class A Facilities prior to Substantial Completion of the Class A Facilities as set forth in Section 6.11.A.(5) for the City's review and comment. Upon completion of the Class A Facilities Operation and Maintenance Manual, PMA shall cause the Company to integrate maintenance management for the Class A Facilities into the existing computerized maintenance management system. The Existing Facilities Operation and Maintenance Manual and the Class A Facilities Operation and Maintenance Manuals shall be referred to collectively as the "Operation and Maintenance Manual."

D. Updates. PMA shall cause the Company to perform the Biosolids Services substantially in compliance with the Operation and Maintenance Manual, once prepared or received. PMA shall cause the Company, at its sole cost and expense, to keep the Operations and Maintenance Manual and the computerized maintenance management system current and shall supply the City with appropriate updates, supplements or revisions thereto annually or at any earlier time that a material change is made for the City's review and comment in accordance with Appendix 8. Such updates shall preserve the standards set forth in the initial Operation and Maintenance Manual. Notwithstanding any such review and comment by and discussion with the City, the Operation and Maintenance Manual shall remain, at all times, the responsibility of PMA and the Company. Neither the review of or comment upon, nor the failure of the City to comment upon, the Operation and Maintenance Manual shall: (1) relieve the Company of any of its responsibilities under this Service Contract; or (2) be deemed to constitute a representation by the City that operating the Operated Facilities pursuant to the Operation and Maintenance Manual will cause the Operated Facilities to be in compliance with this Service Contract.

D. Manufacturer's Warranties. PMA shall cause the Company to be responsible for meeting the City's and PMA's maintenance obligations under all manufacturer's warranties on new equipment purchased and installed in the Operated Facilities.

E. Repair and Replacement of Operated Facilities. PMA shall cause the Company in accordance with the Contract Standards and the Operation and Maintenance Manual to perform in a timely manner all repair and replacement of the machinery, equipment, structures, improvements and all other property constituting the Operated Facilities. PMA shall cause the Company to keep the Operated Facilities in good working order, condition and repair, in a neat and orderly condition, normal wear and tear excepted, and in accordance with the requirements of this Service Contract (including the Appendices and Contract Standards), and shall reasonably maintain the aesthetic quality of the Operated Facilities, normal wear and tear excepted. PMA shall cause the Company to make provisions for all labor, materials, supplies, equipment, spare parts, Consumables and services which are necessary for the normal and ordinary maintenance of the Operated Facilities and shall conduct predictive, preventive and corrective maintenance of the Operated Facilities and keep maintenance logs in accordance with the maintenance plan and Renewal and Replacement obligations as set forth in Appendices 1 and 8.

F. Maintenance of BRC Site. PMA shall cause the Company to keep the grounds of the BRC Site in a neat and orderly condition (including the cleanup of litter and debris on a daily basis or more frequently as required). PMA shall cause the Company to maintain and repair all BRC Site signage, fencing and other security systems.

G. Delivery of Manual and Maintenance System on Termination. On the Termination Date, PMA shall cause the Company to deliver to the City the Operations and Maintenance Manual and the computerized maintenance management system for all Operated Facilities to be owned and managed by the City.

4.4 Staffing and Personnel Training.

A. Staffing. PMA shall cause the Company to staff the Operated Facilities during the Term with adequate levels of qualified personnel who meet the licensing and certification requirements of the State in accordance with Applicable Law and this Service Agreement. PMA shall cause the Company to discipline or replace, as appropriate, any employee of the Company or any Subcontractor engaging in unlawful, unruly or objectionable conduct. PMA shall cause the Company to notify the City of any material change in staffing levels and positions from time to time, and shall not make any such material change if the new staffing level would adversely affect the ability of PMA to provide the Biosolids Services. Notwithstanding the foregoing, the PMA may permit Company to terminate the Facility Manager without City's prior written approval; however, Company shall replace the Facility Manager with a new Facility Manager or an interim Facility Manager within ninety (90) days of such termination, either of which shall be subject to approval by the City. Company shall not hire a new Facility Manager without the City's prior written approval. In addition, if Company significantly reduces the staffing levels set forth in Appendix 2 or Appendix 8, PMA shall notify the City to discuss, in advance of any such proposed reduction.

B. Class A Period Training. PMA shall cause the Company to be responsible for training the Company personnel as set forth in the Training Plan required by Appendix 2. Such personnel training program shall include the personnel training guidelines, policies and procedures established by Applicable Law. In order to facilitate the City's and PMA's capacity to monitor this Service Contract, PMA shall cause the Company, at its costs and expense, to provide one (1) two-week training course for three (3) City designated personnel prior to the commencement of the Class A Period. The City may request additional training from PMA from time to time to ensure adequate capacity for monitoring this Service Contract. Six months prior to any termination of the Service Contract, PMA shall cause the Company to provide training to three (3) City-designated personnel so that such personnel will have the ability to operate and maintain the Operated Facilities after the termination or expiration of this Service Contract.

4.5 Utilities.

A. General. PMA is responsible for arranging for the provision of all utilities and similar services or Consumables needed for providing the Biosolids Services.

B. Interim Period.

(1) Electricity. Electricity for the BRC Site shall be separately metered. The City shall provide electrical power consumed at the BRC Site and PMA shall cause the Company to reimburse the City, through PMA, for the costs incurred by the City for such electricity through a Miscellaneous Credit to the Interim Service Fee issued monthly to the City. PMA shall cause the Company to use its best efforts to assist the City in meeting the annual electrical demand requirements set by the electric utility for the combined BRC and SWWPCP account. The electric demand requirement is ten (10) Megawatts one time annually.

(2) Water Supply. The City shall provide sufficient quantity of potable and process water for PMA's use at no charge to PMA in general accordance with Appendix 1.

(3) Gas. Gas for the BRC Site shall be separately metered. PMA shall purchase gas from the City, and shall reimburse the City for the costs incurred by PMA for such gas through a Miscellaneous Credit to the Interim Service Fee issued monthly to the City. From time to time, PMA shall cause the Company to cooperate in obtaining the lowest possible prices for the purchase of natural gas or oil.

(4) Alternative Fuels. PMA shall cause the Company to purchase fuel other than gas directly from suppliers.

C. Class A Period.

(1) Electricity. Electricity for the BRC Site shall be separately metered. City shall provide electrical power consumed at the BRC Site, and PMA's use of electricity shall be subject to the Company's Maximum Electrical Power Guarantee. PMA shall cause

the Company to use its best efforts to assist the City in meeting the annual electrical demand requirements set by the City's electric utility for the combined BRC and SWWPCP account. The electric demand requirement is ten (10) Megawatts one time annually.

(2) Water Supply. The City shall provide sufficient quantity of potable and process water for PMA's use at no charge to PMA in general accordance with Appendix 2.

(3) Gas or Alternative Fuel. City shall purchase gas and Alternative Fuel directly from utilities or other suppliers. PMA's use of Gas or Alternative Fuel shall be subject to Company's Maximum Natural Gas Guarantee and the Maximum Alternative Fuel Guarantee. From time to time, PMA shall cause the Company to cooperate with the City in obtaining the lowest possible prices for the purchase of natural gas or Alternative Fuel for operation of the Class A Facilities.

(4) Digester Gas. In accordance with this Service Agreement, PMA shall utilize excess Digester Gas produced by the City at SWWPCP and made available by the City at SWWPCP for PMA.

4.6 Safety and Security

A. Safety. PMA shall cause the Company to maintain the safety of the Operated Facilities and the BRC Site at a level consistent with the Safety Program as described in Appendix 1, Applicable Law and any other applicable Contract Standard.

B. Security. PMA shall cause the Company to be responsible for the security of Biosolids Services, including the Operated Facilities, and BRC Site in accordance with the Security Plan developed under Appendix 1 and in accordance with Applicable Law and any other applicable Contract Standard.

4.7 Compliance with Permits and Other Applicable Law

A. Sampling, Testing and Laboratory Work. PMA shall cause the Company to perform and provide all sampling, laboratory testing and analyses, and quality assurance and quality control procedures and programs required by the Contract Standards, including Appendices 1, 7 and 8. All testing laboratories shall comply with the requirements of Applicable Law. PMA shall cause the Company to make all sampling and test data available for review by, and reported to, the City in accordance with Appendices 1, 7 and 8. PMA explicitly assumes the risk of incorrect sampling, testing and laboratory work and any consequences thereof or actions taken or corrections needed based thereon, whether such work is performed by itself or third parties, both as to failures to detect and as to false detections. Subject to Section 4.11, PMA shall permit the City, at the City's expense, to perform any testing, sampling or analytical procedure it deems appropriate, using the Operated Facilities or otherwise.

B. Investigations of Non-Compliance With Applicable Law. In connection with any actual or alleged event of non-compliance with Applicable Law, PMA shall cause the Company to undertake the following activities, in addition to any other duties which Applicable Law may impose:

- (1) fully and promptly respond to all inquiries, investigations, inspections, and examinations undertaken by any Governmental Body;
- (2) attend all meetings and hearings required by any Governmental Body;
- (3) provide all corrective action plans, reports, submittals and documentation required by any Governmental Body;
- (4) in conjunction with the City, through the PMA, communicate in a timely and effective manner with the general public as to the nature of the event, the impact on the public, and the nature and timetable for the planned remediation measures; and
- (5) immediately upon receipt, provide the City, through PMA, with a true, correct and complete copy of any written notice of violation or non-compliance with Applicable Law, and true and accurate transcripts of any verbal notice of non-compliance with Applicable Law, issued or given by any Governmental Body. The Company shall furnish the City, through PMA with an immediate written notice describing the occurrence of any event or the existence of any circumstance which does or may result in any such notice of violation or non-compliance to the extent the Company has knowledge of any such event or circumstance, and of any Legal Proceeding alleging such non-compliance.

C. Fines, Penalties and Remediation. Except to the extent excused by Uncontrollable Circumstances or City Fault, in the event that PMA, the Company or any Subcontractor fails at any time to comply with Applicable Law with respect to the Operated Facilities, the BRC Site, or any aspect of the implementation of the Biosolids Services, or other environmental or operating condition, PMA shall cause the Company, without limiting any other remedy available to PMA, upon such an occurrence and notwithstanding any other provision of this Service Contract:

- (1) promptly correct such failure and resume compliance with Applicable Law;
- (2) bear all resulting Loss-and-Expense;
- (3) pay or reimburse PMA for any resulting Loss-and-Expense, fines, assessments, levies, impositions, penalties or other charges;
- (4) make all changes in operating and management practices and the Operated Facilities or BRC Site which are reasonably necessary to assure that the failure of compliance with Applicable Law will not recur; and
- (5) comply with any corrective action plan filed with or mandated by any Governmental Body in order to remedy a failure of the Company to comply with Applicable Law.

D. No Nuisance Covenant. PMA shall cause the Company to keep the Operated Facilities neat, clean and litter-free at all times, ensure that the operation of the Operated Facilities or the BRC Site does not create any litter, noise, fugitive dust, vector, excessive light or other adverse environmental effects constituting a nuisance condition under Applicable Law. Should any such nuisance condition occur which is not caused by Uncontrollable Circumstances, the Company shall take all commercially reasonable steps to remedy and prevent a recurrence of the nuisance condition, pay any Loss and Expense, fines or penalties relating thereto.

4.8 Operating Governmental Approvals.

A. Applications and Submittals. PMA shall cause the Company to make all filings, applications and reports necessary to obtain and maintain all Governmental Approvals by or in the name of the Company or PMA or the City under Applicable Law in order to provide the Biosolids Services, including the operation of the Operated Facilities, including those set forth in Appendix 10. With respect to Governmental Approvals which are required to be obtained in the name of the City, PMA shall cause the Company to:

- (1) prepare the application and develop and furnish all necessary supporting material;
- (2) supply all data and information which may be required;
- (3) familiarize itself with the terms and conditions of such Governmental Approvals;
- (4) attend all required meetings and hearings; and
- (5) take all other action necessary in obtaining, maintaining, renewing, extending and complying with the terms of such Governmental Approvals. All permit and filing fees required in order to obtain and maintain Governmental Approvals for the Biosolids Services shall be paid by the Company regardless of the identity of the applicant, in accordance with Section 8.2(B)(3)(d) of Article 8 during the Interim Period and Governmental Approvals required in connection with an Uncontrollable Circumstance. The Company shall agree to be named as a co-permittee on any Government Approval if so required by the issuing Governmental Body or PMA. PMA shall cause the Company not to disadvantage PMA or the City in any application, data submittal or other communication with any Governmental Body regarding Governmental Approvals. The final terms and conditions of any Government Approval shall be subject to the City's approval.

B. Data and Information. PMA shall cause the Company to supply or take all data, information and action required in connection with the Governmental Approvals on a timely basis considering the requirements of Applicable Law. The data and information supplied by PMA to all regulatory agencies in connection therewith shall be correct and complete in all material respects, and shall be submitted in draft form to the City sufficiently in advance to allow full and meaningful review and comment by the City, which the City shall do on a timely basis. PMA shall cause the Company to be responsible for any schedule and cost consequences which

may result from the submission of materially incorrect or incomplete information. The City reserves the right to approve any information supplied by the Company pursuant to this Section.

C. Non-Compliance and Enforcement. When known, PMA shall cause the Company to immediately report to PMA and the City all violations of the terms and conditions of any Government Approval or Applicable Law. Following any such violation, the failure of the Company to comply with any order required for Government Approval shall constitute a breach of this Service Contract as well as an event of non-compliance with the Governmental Approval.

D. Reports to Governmental Bodies. PMA shall cause the Company to prepare all periodic and annual reports, make all information submittals and provide all notices required by all Governmental Approvals and under Applicable Law. For all reports requiring the City's signature, the Company first shall provide PMA and the City with copies of such regulatory reports for review, comment and signature, as applicable, at least seven days before their filing. PMA shall cause the Company to make best efforts to provide PMA and the City with all reports relating to non-compliance at least two days prior to filing. If not sooner provided, PMA shall provide copies of all reports to the City at such time as the reports are filed with the respective agencies.

E. Potential Regulatory Change. PMA shall cause the Company shall keep PMA and the City regularly advised as to potential changes in Government Approvals and Applicable Law (including regulatory requirements) affecting the biosolids services industry, and shall provide to PMA and the City the recommended responses to such potential changes so as to mitigate any possible adverse economic impact on the City should a Change in Law actually occur.

4.9 Emergencies.

A. Emergency Spill Clean Up Plan. Prior to the Commencement Date, PMA shall cause the Company to provide the City with a plan of action to be implemented in the event of an emergency related to a spill caused by Company as set forth in Appendix 1.

B. Emergency Action. PMA shall cause the Company to take every reasonable action to protect the safety of the public and its employees, to protect the safety and integrity of the Operated Facilities, and to mitigate the immediate consequences of an emergency event. As promptly thereafter as is reasonable, the Company shall notify the City of the event at an emergency phone number from a list supplied by the City, and the Company's response thereto. The cost of the Company's response measures shall be borne by the PMA and the Company except to the extent caused by an Uncontrollable Circumstance or City Fault.

C. Releases, Leaks and Spills.

(1) Unauthorized Releases. PMA shall cause the Company to perform the Biosolids Services in such a manner that City Biosolids, Dewatered City Biosolids, Product or any other material or substances will not contaminate, or be released, leak or spill on or into the environment due to action, error or omission by the Company ("Unauthorized Release").

(2) Notification and Reporting. PMA shall cause the Company to immediately notify the City and shall fulfill all notification and reporting requirements established by Applicable Law related to any Unauthorized Release. PMA shall cause the Company to prepare a memorandum evidencing such notification and reporting and provide copies thereof to the City, along with any documents provided to the relevant Governmental Body regarding the Unauthorized Release.

(3) Cleanup and Costs. PMA shall cause the Company to coordinate with the City in identifying the source of any Unauthorized Release and shall cooperate with the City and all appropriate Governmental Bodies in effectuating the prompt remediation thereof. PMA shall require the Company, in the most expeditious manner possible under the circumstances, to cause any Unauthorized Release to be cleaned up and shall perform all remediation measures required by Applicable Law. All costs associated with the identification, testing, cleanup, removal, remediation, transportation and disposal of such Unauthorized Release shall be paid by PMA, except that such costs for any City Biosolids classified as Hazardous under Applicable Law shall be a Reimbursable Cost and to the extent the Unauthorized Release resulted from an Uncontrollable Circumstance or City Fault.

4.10 Rolling Stock Operations.

A. Company Rolling Stock. PMA shall cause the Company by ownership, leasing or otherwise, to provide all transportation vehicles, equipment and rolling stock necessary in order to carry out and perform its obligations hereunder, including its obligations to transfer and transport Product for marketing or disposal. Without limiting the foregoing, the Company shall provide or have available a sufficient number of vehicles, equipment and rolling stock and duly licensed and trained operators to provide the transfer, transportation, marketing and disposal services required hereunder. PMA shall cause the Company to have sole responsibility for operating, maintaining, insuring and servicing such equipment, and subject to Uncontrollable Circumstance or City Fault, shall bear all risk of loss thereof or damage thereto, and all risk of damage or injury caused by the operation thereof.

(1) Any rolling stock in possession of Company under the Lease shall be returned to PMA upon:

(a) the end of the useful life of the rolling stock (determined in accordance with a useful life table mutually developed by the parties);

(b) if the rolling stock is no longer useful or necessary for Company operations; or

(c) upon termination of the Service Contract or City Lease.

(2) PMA shall cause the Company to cooperate with the City in responding to requests from the City for inventory control monitoring.

B. Loading and Operation. Each load of City Biosolids or Product being transported shall be fully covered and secured as required by Applicable Law so as to prevent any blowing, spilling or leakage of the waste or material being transported. PMA acknowledges and represents that the Operated Facilities and the BRC Site contain sufficient staging space and operational capabilities to enable PMA through its Service Agreement with the Company to perform all of its handling, transfer and transportation obligations hereunder.

4.11 City Access. PMA shall cause the Company, at all times during the Term, with advance reasonable notice and with reasonable cause, to provide access to the BRC Site to the City for the performance of any obligations that the City may have. All City personnel and representatives shall not interfere with Company activities and shall follow current Company safety protocols at all times they are on the BRC Site. Company personnel may accompany City personnel at all times during any City access. Notwithstanding the foregoing, City shall have access to the BRC Site, without advance notice to PMA or the Company, for the purposes of performing routine maintenance obligations under this Service Contract.

4.12 City Inspections.

A. Agreement Compliance Inspection. The City or the City Engineer or other representatives of the City may, upon reasonable written notice, perform a comprehensive inspection of the Operated Facilities and the BRC Site and relevant records of PMA and the Company each Contract Year to determine compliance with this Service Contract. PMA shall cause the Company to cooperate fully with such inspections, which shall not interfere unreasonably with the Company's performance of the Biosolids Services. Notwithstanding the foregoing, the City shall not, unless presenting reasonable evidence that PMA is not complying with the Service Contract, perform such comprehensive compliance inspections of the Operated Facilities more than once annually.

B. City Access for Other Inspections. Upon reasonable notice, PMA shall cause the Company to provide access to the City and its representative to the BRC Site and relevant records and to other locations where Biosolids Services may be occurring for the performance of any inspections and observations, subject to the limitations set forth in Section 4.12 A. with respect to comprehensive inspections. All City personnel and representatives shall not interfere with PMA or Company activities and shall follow current safety protocols at all times they are in the Operated Facilities. Company personnel may accompany City personnel at all times during any inspection.

C. Unscheduled Emergency Inspections. Nothing in this Section shall limit the City's right, on an unscheduled, true emergency basis, at any time to enter the Operated Facilities and the BRC Site to perform emergency measures for the health and safety of the public.

D. Unscheduled Regulatory Inspections. Nothing in this Section shall limit the right of regulatory agencies or Governmental Bodies, with jurisdiction over the BRC Site or the Operated Facilities, to enter the Operated Facilities and the BRC Site, on an unscheduled, but lawful basis, at any time to perform lawful regulatory inspections.

E. Remediation. Based on any reports submitted by PMA or the inspections conducted pursuant to this Section, the City may submit a statement to PMA detailing any breaches of this Service Contract found and requiring PMA to cause the the Company to submit a plan of remediation. The remediation plan shall be sufficient to reasonably demonstrate that, if implemented, the Biosolids Services, including the Operated Facilities and the BRC Site will be promptly brought into compliance with the requirements of this Service Contract. If the City accepts the remediation plan, PMA shall cause the Company to correct all deficiencies noted in such plan. Failing such corrective action by the Company, the City may take corrective action and the Service Fee shall be reduced by the amount of the City's cost of remediation, minus costs incurred by PMA due to the City's remediation but not directly related to PMA Fault.

ARTICLE 5

OWNERSHIP AND FINANCING

5.1 Ownership of Operated Facilities and Lease of the Existing Facilities and the BRC Site.

A. Ownership of Operated Facilities and BRC Site. PMA shall cause the Company to own the Class A Facilities and improvements to the Existing Facilities, subject to the terms and conditions of the Service Agreement. The City shall retain ownership of the Existing Facilities and the BRC Site.

B. City Lease of the Existing Facilities and the BRC Site to PMA. Pursuant to the City Lease, the City shall let the Existing Facilities and the BRC Site to PMA, and PMA shall let the Existing Facilities and the BRC Site to the Company under the Lease.

5.2 Financing of Design/Build Work.

A. Terms of Financing. PMA shall cause the Company to arrange and effectuate the financing of the Class A Facilities in accordance with the principles set forth in the preliminary Finance Plan set forth in Appendix 11. PMA shall cause the Company to deliver to PMA and the City a Finance Plan within 180 days following the Service Contract Date. The Finance Plan shall address in detail all of the matters addressed in the preliminary Finance Plan, and fully describe the Company plan to arrange for debt and equity funds sufficient to pay the capital costs of the Class A Facilities and the improvements to the Existing Facilities, including the nature of any debt issuance, loan or credit facilities, equity contribution, funding by the Company, or other financing, the transaction participants, structure, terms and security; the extent to which any debt issue will be tax-exempt or taxable; and copies of all draft and final documentation prepared and entered into to effectuate any such transaction.

B. Responsibility for Financing. Subject to the provisions of this Section 5.2(B), PMA shall cause the Company itself or through third-party financing or other equity contributions shall provide in a timely manner all funds required to perform the Design/Build Work. The obligations of PMA and the Company under this subsection shall apply notwithstanding the occurrence of an Uncontrollable Circumstance or any other event or circumstance within or outside the control of PMA or the Company provided that PMA shall be entitled to recover increased costs caused by an Uncontrollable Circumstance if otherwise provided herein.

(1) Notwithstanding the foregoing, the City recognizes that Company intends to arrange for third party debt to finance a significant portion of the Design/Build Work. PMA's and the Company's responsibility to provide non-debt funding for the Design/Build Work shall be limited to an equity contribution of \$15 Million. The Company shall reasonably demonstrate, as part of the Finance Plan, its capability and willingness to contribute \$15 Million to the Design/Build Work. If Company cannot obtain commercially reasonable third-party debt financing using commercially reasonable

efforts, for the remaining costs of the Design/Build Work, PMA may terminate its obligations under this Service Contract as set forth in Section 5.6.

(2) Nothing in this Section shall permit PMA to terminate Interim Period Biosolids Services due to Company's failure to finance the Class A Facilities under Section 5.2(B)(1). Notwithstanding the termination of its obligations relative to the Class A Facilities pursuant to Section 5.2(B)(1), PMA shall cause the Company, at the discretion of the City, to continue to provide all Interim Period Services for a period of up to sixty (60) months after the Commencement Date or two (2) years after the termination of its obligations relative to the Class A Facilities pursuant to Section 5.2(B)(1), whichever is later, after which time this Service Contract shall terminate.

(3) Subject to this Section and the Service Fee adjustments set forth in Section 8.4, PMA shall cause the Company to specifically agree to bear the risk of any adverse change in the financial markets or in the financial condition of the Company, the Guarantor or any other Affiliate of the Company, the unavailability for any reason of a particular third-party financing, and the unwillingness of certain banks, insurance companies or other corporate or financial institutions to provide any credit enhancement, derivative product or other instrument judged to be necessary to secure financing or hedge or manage financial risk.

(4) All financing provided by the Company shall be consistent in all material respects with the preliminary and final plans of financing prepared pursuant to Appendix 11 unless otherwise approved by the City. Except as otherwise provided in this Service Agreement, PMA shall prohibit the Company from engaging in any leveraged lease or similar financing transaction which places ownership of the Class A Facilities with a third party.

C. Responsibility for Costs. PMA shall cause the Company to bear, and the City shall not be directly responsible (the City's payment of the Service Fee excluded) for any costs relating to its responsibility to provide financing or right to obtain third-party financing hereunder, including placement, counsel, advisory, filing or other transaction fees and expenses.

D. Limitation on Class A Facilities Secured Borrowing. In no event shall PMA permit the Company to use or permit the use of the Class A Facilities or the revenues therefrom as collateral or security for any borrowings other than (1) Class A Facilities Obligations or (2) other indebtedness the proceeds of which are expended on the Class A Facilities or the BRC Site.

E. Consistency with Service Contract. The terms of conditions of any and all documentation entered into or prepared in connection with any financing transaction arranged by the Company pursuant hereto shall not be inconsistent with this Service Contract and shall not materially and adversely affect the City's rights and obligations hereunder. All such documentation shall be furnished to the City in draft form prior to finalization sufficiently in advance to permit a thorough and considered review by the City for such purposes, as well as in final form.

F. No Obligation of City in Connection with Facility Financing. The City shall be under no obligation to incur, bear or assume any additional risk, cost, liability or burden in connection with the financing of the Class A Facilities beyond those risks, costs, liabilities and burdens provided for herein. In the event any such additional commitment is required of the City in order for PMA to cause the Company to arrange for and effectuate the financing of the Class A Facilities, the City shall be under no duty to provide such additional commitment and such shall not be deemed to be a City Fault.

G. Sale, Lease and Transfer. Unless specifically provided herein to the contrary, PMA shall not be allowed to sell, lease, sublease, convey, transfer, assign or dispose of its interest in the Class A Facilities, or any part thereof, without the prior written consent of the City.

5.3 Protection of Lender.

A. Leasehold Mortgage. PMA may permit the Company from time to time, subject to the terms and conditions of the Service Agreement, to grant a Leasehold Mortgage and pledge to the Lender all or any part of the Company's interest or rights in or to the Service Agreement, the Lease, the Class A Facilities or any Service Fee which pledge or assignment is hereby consented to by PMA subject to the provisions of this subsection. During the Term, the Lender shall be entitled to the protections set forth in this Section if the Lender has:

- (1) given notice to the City of a loan or other financing to the Company,
- (2) specified the amount, amortization and other terms of such loan and described the nature of the transaction under which the Lender has been granted or acquired an interest from the Company,
- (3) provided the City with the Lender's address for notices hereunder, and
- (4) acknowledged the City's rights with respect to PMA, the Lender and the Class A Facilities as security for the Class A Facilities Obligations, and the terms under which the Company may and may not incur Class A Facilities Obligations, grant a Leasehold Mortgage or otherwise allow Encumbrances to be placed on the Class A Facilities, all as provided in this Service Contract and the Service Agreement.

B. Further Assurances. The City shall, from time to time at the request of PMA or the Lender, take any and all actions, including without limitation the amendment of the Financing Documents, the Service Contract, or the execution of new or additional consents or other documents, which may be reasonably necessary or helpful to implement the provisions of this Section or to facilitate the financing of the Class A Facilities with the Lender; provided, however, that such amendment or other document shall not in any way affect the Term or affect adversely any rights of the City or PMA pursuant to this Service Contract or in respect of the Class A Facilities Obligations.

5.4 City Buy-Out Option.

A. At any time after the tenth anniversary of the Commencement Date, the City may elect to assume ownership of the Company-owned Operated Facilities. In such event, the City shall provide no less than one hundred (100) days prior written notice ("Notice of Buy-Out") to PMA that the City shall assume ownership of the Company-owned Operated Facilities on a specified date (the "Buy-Out Date"). Upon the Buy-Out Date, the City shall make payment to PMA as set forth in Section 14.1(A) of Appendix 14 and such additional payments that may be required in Section 5.4 B. and Section 5.4 D.

B. In the event that the City also elects to remove PMA and Company as operator of the Company-owned Operated Facilities on the Buy-Out Date, without ceasing operation of the Class A Facilities, the City shall provide notice of such to PMA in the Buy-Out Notice and, in addition to such amounts to be paid by the City pursuant to Section 5.4.A, the City shall also make payment to PMA in accordance with Schedule 1, shown in Section 14.1.(B) of Appendix 14.

C. If the City requires PMA and the Company to continue to operate the Company-owned Operated Facilities, the City shall make the payment to PMA required by Section 14.1 (A) of Appendix 14 on the Buy-Out Date, but no additional payment in accordance with Section 14.1(D) of Appendix 14.

D. If the City shall not assume operation of the Class A Facilities and shall cease operation of the Class A Facilities entirely, in addition to such amounts to be paid by the City pursuant to Section 14.1(A) of Appendix 14, the City shall make payment to the PMA in the amount set forth in Schedule 2, shown in Section 14.1(C) of Appendix 14 on the Buy-Out Date.

E. Even if PMA shall no longer operate the Class A Facilities after the Buy-Out Date, the Service Contract may or may not be terminated on the Buy-Out Date because the City may desire PMA to cause the Company to continue to provide some services other than operation of the Class A Facilities. If the City shall terminate the Service Contract on the Buy-Out Date, it shall provide notice of same in the Buy-Out Notice. In any event that the Service Contract shall not be terminated by the City on the Buy-Out Date, within thirty (30) days of the Buy-Out Notice, the City and PMA shall meet for the purpose of determining those sections of this Service Contract which shall be affected and how such sections must be amended to reflect the new contractual relationship of the parties for the remainder of the Term. Notwithstanding anything stated to the contrary herein, nothing in this Section shall require PMA, unless otherwise agreed by PMA, to provide Interim Services or other non-Class A Period services for more than two (2) years after the Buy-Out Date.

5.5 Refinancing Class A Facilities Obligations. In the event that, in the City's or PMA's or opinion, the debt service on the Class A Facilities Obligations can be reduced through a refinancing, the Company, at the direction of PMA, shall refinance, refund or restructure the Class A Facilities Obligations. The City shall share equally in all reasonable transaction costs in

connection with any such refunding, refinancing or restructuring. The benefit of any such refinancing shall be shared in the following manner: 50% to the Company and 50% to the City.

5.6 Liquidated Damages and Termination for Failure to Provide Funds to Design Build Work.

A. Subject to Section 5.6(B), in the event that PMA through the Company is unable to achieve the Financial Close Date in accordance with Section 5.2 within fifteen (15) months of the Service Contract Date, if the Contract has not been terminated by the PMA in accordance with Section 5.2, the City may terminate the Service Contract or only that part of the Service Contract related to the Class A Period services. In the event that the part of the Service Contract related to the Class A Period service is terminated, PMA shall have no further obligation under the Service Contract to finance, design, construct, own or operate the Class A Facilities and the City shall have no further obligation under the Service Contract to pay any Service Fee related to the Class A Facilities or the provision of Biosolids Services related to the Class A Period; however, PMA shall cause the Company to continue to provide the Interim Period Services in accordance with this Service Contract and Section 5.2(B)(2). Upon termination of this Service Contract in accordance with Section 5.2(B)(2) and this Section, PMA shall pay to the City the sum of Two Million Five Hundred Thousand Dollars (\$2,500,000). Upon termination of the Service Contract under this Section, other than the obligations set forth in Section 5.2(B)(2) and payment of liquidated damages by PMA in accordance with this Section, neither party shall have any further liability to the other. Specifically, PMA shall not be liable for damages as set forth in Sections 6.2 (D) and 6.18(C).

B. Extension of the Financial Close Date. PMA's obligation to attain the Financial Close Date within fifteen (15) months after the Service Agreement Date may be extended under the following circumstances. So long as the Company has submitted to the Air Management Services ("AMS") division of the City of Philadelphia, within six (6) months of the Service Agreement Date, a completed air permit application created to professional industry standards, for each day that the AMS review and approval process exceeds six (6) months from the date of application submission, the Company shall receive a like extension of the fifteen (15) month Financial Close Date deadline. Alternatively, and at the City's discretion, instead of extending the fifteen month period, the City may direct PMA, subject to Company's ability to do so, to close on the Financing Obligations within the fifteen month period, so long as the City shall be responsible to:

- (1) adjust the Fixed/Design/Build Price to include all additional transaction and/or issuance costs, including but not limited to additional capitalized interest and letter of credit fees that the Company incurs if disbursement of Class A Financing Obligations funds by the Lender is made contingent upon Company's receipt of the approved air permit from AMS; and
- (2) pay all transaction and/or issuance costs if no air permit is ultimately issued.

ARTICLE 6

DESIGN AND CONSTRUCTION OF THE CLASS A FACILITIES

6.1 BRC Site Suitability.

A. BRC Site Familiarity and Confirmation. PMA has caused the Company to acknowledge that the Company's agents and representatives have visited, inspected and are familiar with the BRC Site, its physical condition relevant to the obligations of the Company pursuant to this Service Agreement, specifically with regard to surface conditions, normal and usual soil conditions, roads, utilities, topographical conditions and air and water quality conditions; that the Company is familiar with other local conditions which may be material to the Company's performance of its obligations under this Service Agreement (including, but not limited to transportation; seasons and climate; access, availability, disposal, handling and storage of materials and equipment; and availability and quality of labor and Utilities), and has received and reviewed all information regarding the BRC Site provided to it or obtained in the course of performing its obligations hereunder, and that in reliance on the foregoing, the BRC Site constitutes an acceptable and suitable site for the construction and operation of the Class A Facilities in accordance herewith, and the Class A Facilities can be constructed on the BRC Site no later than five (5) years from the Service Agreement Date.

B. Assumption of Structural Suitability Risk. PMA has caused Company to base its Design/Build Work pricing on the assumption that all subsurface conditions are as shown in previously performed geotechnical data including ("Geotechnical Investigation, Dry Polymer Silos, BRC, Philadelphia, PA" by URS Greiner Woodward Clyde, July 26, 1999) and geotechnical investigations performed by CH2M Hill in July, 2005, as reported in *Philadelphia Water Department Contract Operations for the Biosolids Recycling Center Revised TM 07-Geotechnical dated August 29, 2005*, (collectively, "Geotechnical Data").

(1) Based on the investigations of the BRC Site and other inquiries made by the Company prior to the Service Contract Date, which the Company acknowledges to be sufficient for the design of the piles and foundations, the Company assumes the risk specifically related to the pile and foundation design of the BRC Site and agrees that differing subsurface geotechnical conditions revealed during construction specifically modifying the pile and foundation design will not be an Uncontrollable Circumstance.

(2) Other than as provided in Section 6.1 B.(1), should differing subsurface conditions be encountered from those reasonably anticipated from the Geotechnical Data in Section 6.1 B. such that the cost or schedule of Design/Build Work necessarily be increased, the differing subsurface conditions, shall be treated as Uncontrollable Circumstances, except as specifically provided herein.

C. Surveys. For the Class A Period, PMA shall cause the Company to be responsible for all surveys required for determining the boundaries of the Leased Premises and locations of improvements to the BRC site.

6.2 Design; Conditions to Construction Date for the Class A Facilities.

A. Company to Perform Design Work.

(1) Commencement and Conduct of Design Work. Design Work may commence at any time after the Commencement Date. PMA shall cause the Company to pay the cost of the Design Work and PMA shall cause the Company to perform the Design Work in accordance with the Contract Standards and to have exclusive responsibility for all means, methods, techniques, sequences and procedures used in the design of the Existing Facilities improvements and the Class A Facilities. Subcontracts entered into by the Company for the design of the Existing Facilities improvements and Class A Facilities shall neither supersede nor abrogate any of the terms or provisions of this Service Contract, and as required in Section 12.6 E, shall be assignable to City.

(2) Design. PMA shall cause the Company to have sole and exclusive responsibility for the design of the Class A Facilities, including the preparation of all plans, specifications, drawings, blueprints and other design documents necessary or appropriate to the Design/Build Work. All such design documents shall comply in all material respects with the Design Requirements and shall ensure that the Class A Facilities are constructed to a standard of quality, durability and reliability which is equal to or better than the standard established by the Design Requirements. The City shall have the right to review, but shall have no approval rights with respect to, such design documents. The design review procedures to be followed by the parties during the design of the Class A Facilities are set forth in Appendix 2.

(a) Qualifications. Architects and engineers engaged by the Company for Class A Facilities design services shall be licensed to practice in the State and shall be experienced and qualified to perform such services.

(b) MBEC Approval. Subcontractors for Design Work proposed by Company under Appendix 12 must be approved by MBEC prior to the commencement of Design Work.

(3) Changes to Design Requirements. The PMA agrees that no change to the Design requirements which diminishes the quality, durability or reliability of the Design/Build Work shall be made without an approved Change Order.

(4) Change Orders. The PMA may propose to the City or the City may request Change Orders during the Design Work. The City shall bear the cost of all Change Orders it approves. All Change Orders must be submitted in writing and must be approved in writing by the City to be valid. PMA expressly acknowledges that the City

shall not be authorized to enter into any agreement for a material Change Order without the prior passage of a City Ordinance authorizing same.

B. Conditions Precedent to Construction Work.

PMA shall not allow the Company to commence with the Construction Work until the PMA or the Company has satisfied the following conditions:

- (1) Site Conditions. Made all further analyses, soil test borings and conducted analyses of subsurface conditions, inspected and made applicable site history reviews of the BRC Site as preparation for the design and construction of the Class A Facilities.
- (2) Project Schedule. Prepared and provided the City, through PMA with an update of the Project Schedule to include a detailed schedule for constructing the Class A Facilities in accordance with Appendix 2.
- (3) Required Design and Construction Documents. Submitted all documents required by Appendix 2.
- (4) Construction Governmental Approvals. Obtained all necessary Governmental Approvals including those in Appendix 10.
- (5) Company Security for Performance. Have obtained and delivered to the City, through PMA, the Service Contract Performance Bond as required in Section 12.2(B)(1) as of the Commencement Date and such bond continues in full force and effect and has delivered to the City, through PMA, the Construction Performance Bond and the Labor and Materials Payment Bond as required in Section 12.2(B)(2).
- (6) Required Insurance. Obtained and delivered to the City, through PMA certificates of insurance for all Required Insurance, including for the Design/Build Work, as set forth in Appendix 12. At City's request PMA shall cause Company to deliver copies of any or all insurance policies.
- (7) Financial Condition Update. Confirm that, since the Service Contract Date, no change, financial or otherwise, in the condition of the Company's Guarantor that would materially and adversely affect the ability of the Guarantor to perform its obligations under the Guaranty Agreement should have occurred.
- (8) MBEC Approval. Obtained approval from the City's MBEC for M/W/DSBE subcontractors to be used in Construction Work in accordance with Appendix 13.

C. Establishment of the Construction Date. PMA shall cause the Company to give the City, through PMA, prompt notice when each condition set forth in Section 6.2 B. above has been achieved including written documents or instruments which show such achievement. The City shall promptly accept or waive the achievement of all such conditions and the parties shall mutually certify that the Construction Date has occurred. The date of such mutual certification shall be deemed the Construction Date.

D. Failure of Construction Date Conditions and City Right to Terminate. If by the third anniversary of the Service Contract Date (as such date may be extended pursuant to this Service Contract) or by such later date upon which the City may agree in writing, the Construction Date has not occurred, the City may, by notice in writing to PMA, terminate those provisions of this Service Contract relating to the Class A Facilities and the Class A Period. In such event the Term for the Interim Period may be extended, at the option of the City, so long as such Interim Services shall cease not more than sixty (60) months after the Commencement Date, or two years (2) after the date that Class A Period obligations are terminated, whichever is later, after which time the Service Contract shall terminate. Notwithstanding the foregoing, if the failure to meet the Construction Date Conditions results from a denial of any Governmental Approval that the Company has elected to appeal, the City may not terminate the Class A portion of this Service Contract under this Section for an additional one year period unless the Company ceases to diligently pursue the appeal. If the City's termination of the Class A portion of this Service Contract under this Section 6.2 D is due to PMA's failure to satisfy any of the Company Construction Date Conditions set forth under Section 6.2 B and such failure is not excused by an Uncontrollable Circumstance or City Fault, then not later than thirty (30) days after termination of the Service Contract, PMA shall pay liquidated damages to the City in the amount of Two and One-Half Million Dollars (\$2,500,000). Other than the obligations to continue Interim Services and the payment of liquidated damages by PMA set forth in this Section, neither party shall have any further liability to the other in the event of termination by the City under this Section 6.2 D. Specifically, PMA shall not be liable for damages as set forth in Sections 5.6 and 6.18(C).

E. Lender's Cure Rights for Failure to Meet Construction Date Conditions. If City has notified PMA that it intends to terminate the Service Contract pursuant to 6.2 D., Company's Lender shall have the right to an additional six (6) month period to meet the Construction Date Conditions, provided that Lender shall provide the City with a plan and reasonable assurances that the Construction Date conditions will be met within six (6) months.

6.3 Construction of Class A Facilities.

A. Construction – Commencement and Conduct. Immediately following the Construction Date, PMA shall cause the Company to undertake, perform, complete and pay the cost of the Construction Work in accordance with all of the provisions and requirements of this Service Contract. The Company shall perform the Construction Work in accordance with the Contract Standards and shall have exclusive responsibility for all means, methods, techniques, sequences and procedures used in the design and construction of the Existing Facilities improvements and the Class A Facilities. The Company shall commence the preparation of the BRC Site, including the decommissioning of certain Existing Facilities, as more specifically set forth in Appendix 2, the disposal of any debris thereon and any soil excavated therefrom. The Company shall proceed with due diligence to cause the Existing Facilities improvements and the Class A Facilities to be designed and constructed in accordance with the Design Requirements, shall cause the Class A Facilities shakedown operations to occur, and shall cause the Class A Facilities to be tested for Acceptance Test Standards Achievement in accordance with this Service Agreement all so that the Class A Facilities are suitable and adequate for the purpose of receiving and processing City Biosolids and producing Class A Product in accordance with this Service Agreement.

Subcontracts entered into by the Company for the design and construction of the Class A Facilities shall neither supersede nor abrogate any of the terms or provisions of this Service Agreement. Laydown and staging areas for construction materials shall be located on the BRC Site or at other locations arranged and paid for by the Company

B. Construction Costs and Financing. PMA shall cause the Company, from the funding sources described in Article 5 or otherwise, to pay directly all costs and expenses of the Design/Build Work of any kind or nature whatsoever. All payments by the City to PMA for Design/Build Work shall not be paid directly by PMA but are included in the Service Fee. Such costs and expenses shall include all costs of permitting, regulatory compliance and Legal Proceedings brought against the Company; obtaining and maintaining all forms of Company credit enhancement required hereunder during the Class A Period; payments due under any Subcontracts for all labor and materials; legal, financial, engineering, architectural and other professional services of the Company; general supervision by the Company of all design and construction; Company preparation of schedules, budgets and reports; keeping all construction accounts and cost records; and all other costs required to achieve Acceptance Test Standards Achievement.

C. Governmental Approvals Necessary for Construction. PMA shall cause the Company, with the cooperation of City as herein provided, to make all filings, applications and reports necessary to obtain and maintain all Governmental Approvals in a form and substance satisfactory to the City, in order to commence and continue the construction, shakedown and testing of the Class A Facilities, including those set forth in Appendix 10 and to assure that the terms and conditions thereof are not inconsistent with the PMA's obligations under this Service Contract. Where required under Applicable Law, such applications shall be made in the City's name, subject to the City's rights hereunder. PMA shall cause the Company to manage the process of obtaining the Governmental Approvals on the City's behalf for which it is responsible hereunder in a manner which affords the City a reasonable opportunity to review and comment upon material documentation submitted to and issued by any Governmental Body in connection therewith.

D. Required Insurance. PMA shall cause the Company to obtain and maintain the Required Insurance in accordance with Appendix 12.

E. Compliance With Law and Equipment Operating Requirements. In designing, constructing, shaking down and testing the Class A Facilities, PMA shall cause the Company to comply with Applicable Law, shall construct and operate the Class A Facilities in accordance with Good Engineering and Construction Practice and applicable equipment manufacturer's requirements and recommendations and other applicable Contract Standards.

F. Engagement of PMA Engineer. PMA shall cause the Company to fully cooperate with all reasonable requests made by the City or the City Engineer in connection with the Design/Build Work and other performance of the Biosolids Services. the City's engineering fees shall be paid by the City, except that the PMA shall reimburse the City for reasonable expenses incurred in connection with any services performed by the City in connection with the repetition

of all or any portion of the initial Acceptance Tests unless and to the extent any such additional Acceptance Tests are required as a result of an Uncontrollable Circumstance, or City Fault.

6.4 Personnel.

A. Personnel Performance and Requirements. PMA shall cause the Company to require that all persons engaged by the Company for Construction Work shall have requisite skills for the tasks assigned. Each such engineer and consultant shall have current professional registration or certification to practice in the State.

B. Construction Superintendent. PMA shall cause the Company to designate an agent, representative or employee of the Company (the "Construction Superintendent") who shall be present on the BRC Site on a full-time basis during the Construction Work. The Construction Superintendent shall, among other things: (1) be familiar with the design and with the Construction Work and all requirements of this Service Agreement; (2) coordinate and supervise the Construction Work; (3) maintain a daily status log of the Construction Work; and (4) attend monthly progress meetings with the City.

C. Labor Disputes. PMA shall cause the Company to have exclusive responsibility for disputes or jurisdictional issues among any unions or trade organizations representing employees of the Company or its Subcontractors.

D. Prevailing Wages. PMA shall cause the Company to pay or cause to be paid prevailing wages as set forth in Section 13.3.

6.5 Construction Review, Observations, Testing and Uncovering of Work.

A. Observations and Construction Review Program. During the progress of the Design/Build Work through Acceptance Test Standards Achievement, PMA shall cause the Company to afford the City every reasonable opportunity for observing all Design/Build Work at the BRC Site, and shall comply with the design and construction review procedures set forth in Appendix 2. During any such observation, all City representatives shall comply with all reasonable safety and other rules and regulations applicable to presence in or upon the BRC Site or the Class A Facilities, including those adopted by the Company, and shall in no material way interfere with the Company's performance of any Design/Build Work.

B. Tests. PMA shall cause the Company to conduct tests of the Construction Work (including shop tests) or inspections required by Good Engineering and Construction Practice, the Design Requirements, Applicable Law, or Insurance Requirements. The Company shall give the City and the City Engineer reasonable advance notice of tests or inspections. If required by Applicable Law or Insurance Requirements, the Company shall engage a registered engineer or architect to conduct or witness any such test or inspection. All analyses of test samples shall be conducted by persons appearing on lists of laboratories authorized to perform such tests by the State or federal agency having jurisdiction or, in the absence of such an authorized list in any particular case, shall be subject to the City's approval. Acceptance Testing of the performance of the completed Class A Facilities shall be conducted in accordance with Appendix 6.

C. Certificates and Reports. PMA shall cause the Company to secure and deliver promptly to the City copies of all required certificates of inspection, test reports, work logs, or approvals with respect to the Design/Build Work as and when required by the Design Requirements or by Applicable Law or Insurance Requirements. PMA shall cause the Company to provide the City, immediately after the receipt thereof, copies of any notice of default or noncompliance received by the Company under or in connection with Applicable Law (including Governmental Approvals), Subcontract, Performance Bond, or other Transaction Agreement.

D. Notice of Covering Design/Build Work. PMA shall cause the Company to give the City reasonable notice of its upcoming schedule with respect to the covering and completion of any Construction Work. The City shall give PMA and the Company reasonable notice of any intended inspection or testing of such Construction Work in progress prior to its covering or completion, which notice shall be sufficient to afford the City a reasonable opportunity to conduct a full inspection of such Construction Work without delaying the Company's construction schedule.

E. Progress Meetings and Reports. PMA shall cause the Company to conduct one progress meeting per month with the City. At such meetings, discussions will be held concerning all aspects of Class A Facilities design and construction. Monthly reports containing all relevant information shall be prepared by the Company and provided to the City at least five days prior to each monthly meeting. PMA shall cause the Company to use reasonable efforts to keep the City informed of its estimates of the start date for shakedown operations, the date upon which the Acceptance Tests will commence and the ATSA Date.

F. Deliverable Material. PMA shall cause the Company to deliver to the City all Deliverable Material required to be provided under Appendices 1, 2 and 8 at the times specified therein. All Deliverable Material received by the City hereunder shall be used solely for the purposes of this Service Contract, and any proprietary information contained therein shall be treated in the manner required by Section 12.4.

G. Project Schedule. PMA shall cause the Company to perform the Design/Build Work in accordance with the Project Schedule. PMA shall cause the Company to submit to the City an updated monthly Project Schedule along with each monthly progress report.

H. Delivery of Drawings. PMA shall cause the Company to provide to the City and maintain as-built or record drawings and documents at the BRC Site for inspection by the City, and shall provide all Class A Facilities and improvements to Existing Facilities drawings to the City on diskette in MicroStation or AutoCAD format. PMA shall cause the Company to maintain and, if necessary, make revised drawings available in the same manner as the original drawings.

6.6 Change Orders. PMA may propose Change Orders to the City or the City may request Change Orders during the Construction Work. The City shall bear the cost of all Change Orders it approves. All Change Orders must be submitted in writing and must be approved in writing by the City to be valid. PMA expressly acknowledges that the City shall not be authorized to enter

into any agreement for a material Change Order without the prior passage of a City Ordinance authorizing same.

6.7 Correction of Work.

A. Correction of Nonconforming Design/Build Work. PMA shall cause the Company to promptly complete, repair, replace, restore, rebuild and correct any Construction Work which does not materially conform with the Design Requirements.

B. Relation to Other Obligations. The obligations specified in subsection 6.7A. above establish only the PMA's specific obligation to correct the Construction Work and shall not be construed to establish any limitation with respect to any other obligations or liabilities of the Company under this Service Agreement.

6.8 Damage to the Construction Work.

A. Damage Prevention. PMA shall cause the Company to use reasonable care and diligence and shall take reasonable precautions to protect the Existing Facilities and Construction Work from damage.

B. Restoration. In case of damage to the Construction Work, and regardless of the extent thereof or the estimated cost of restoration, and whether or not any insurance proceeds are sufficient or available for the purpose, to the extent caused by PMA or Company Fault, PMA shall cause the Company to promptly undertake and complete restoration of the damage to Construction Work to the character and condition existing immediately prior to the damage.

C. Notice and Reports. PMA shall cause the Company to notify the City and the insurers under any applicable Required Insurance of any damage to the Construction Work and of any accidents on the BRC Site promptly after the Company learns of any such damage or accidents; and, promptly following any such occurrence, the Company shall submit a written report to PMA. PMA shall cause the Company shall also submit to the City copies of all accident and other reports filed with (or given to the Company or PMA by) any insurance company, adjuster, or Governmental Body.

6.9 Construction Performance. PMA shall cause the Company to ensure the performance of its Subcontractors in the Construction Work. PMA covenants that any benefits it receives as obligee or beneficiary of any surety provided for the performance of the Construction Work shall be utilized for the sole benefit of the Construction Work or as otherwise directed by the City relative to the project.

A. Default of Construction Subcontractors

(1) PMA shall cause the Company to provide written notice to the City of a breach or default by any Subcontractor within five days of its notification to the Subcontractor of the breach or default.

City-PMA Service Contract

(2) PMA shall cause the Company to provide immediate written notice to the City of any abandonment or anticipated abandonment of the Construction Work.

PMA shall cause the Company to provide to the City copies of any correspondence between the Company and Subcontractors' surety with regard to any breach of a Subcontract, including any failure of Subcontractor to maintain required surety.

6.10 Ownership and Discharge Of Encumbrances.

A. Ownership. The City acknowledges that the Class A Facilities and all equipment, materials, vehicles and supplies purchased by the Company to be used in or about the Class A Facilities, and all plans, drawings and other documentation with respect thereto, shall be legally or beneficially owned by the Company or its assigns.

B. Risk of Loss. Risk of loss of the Class A Facilities and of all equipment, materials and supplies used or consumed in the Construction Work shall rest solely with the Company, subject to the provisions of this Service Contract.

6.11 Substantial Completion.

A. Conditions to Substantial Completion. PMA shall not permit the Company to commence start-up operations in preparation for conducting the Acceptance Test until Substantial Completion has occurred. Substantial Completion shall occur only when all of the following conditions have been satisfied:

- (1) the Company has obtained all applicable Governmental Approvals and is authorized to conduct the Acceptance Test and to operate the Class A Facilities under Applicable Law;
- (2) all Utilities necessary for the operation of the Class A Facilities have been arranged for by the Company and are connected and functioning properly;
- (3) PMA has caused the Company to delivered to the City written certification from the equipment manufacturers that all major items of machinery and equipment included in the Class A Facilities have been properly installed and tested in accordance with the manufacturers' recommendations and requirements;
- (4) PMA has caused the Company to deliver to the City copies of all warranties that Company has received related to the improvements to the Existing Facilities and the Class A Facilities;
- (5) PMA has caused the Company to deliver to the City the draft Class A Facilities Operation and Maintenance Manual;
- (6) The City has reviewed and approved the Company's plan for Acceptance Testing as required by Appendix 6;

(7) PMA has caused the Company to obtain Required Insurance as set forth in Appendix 12; and

(8) PMA has caused the Company to complete the Construction Work in accordance with the Design Requirements, except for the punch list items that have been approved by the City.

Promptly upon such satisfaction, Substantial Completion shall be acknowledged in writing by the City. Alternatively, Substantial Completion shall occur on any date certified by the City before all conditions have been satisfied, as the City shall have discretion to waive any of the foregoing conditions.

6.12 Acceptance Test Plan and Notices to the City.

A. Submittal of Acceptance Test Plan. At least 120 days before the date upon which the Company plans to begin Acceptance Testing, PMA shall cause the Company to prepare and submit to PMA for its review a detailed Acceptance Test Plan, which shall conform to the requirements of Appendix 6. Within sixty (60) days after the Company's submission of the detailed Acceptance Test Plan, the City shall either notify the Company of the City's specific objections to the plan, at which time the parties shall promptly meet and endeavor to negotiate in good faith to resolve the City's objections and finalize the Acceptance Test Plan, or shall notify PMA and the Company that the City has no objections to the Acceptance Test Plan.

B. Notice of Substantial Completion. PMA shall cause the Company to give the City at least thirty (30) days prior written notice of the expected date of Substantial Completion and of commencement of start-up operations at the Class A Facilities in preparation for conducting the Acceptance Test.

C. Notice of Commencement of Acceptance Test. PMA shall cause the Company to also provide the City with at least thirty (30) days prior written notice of the expected initiation of the Acceptance Test in accordance with the requirements of Appendix 6. At least ten (10) days prior to the actual commencement of Acceptance Testing, the Company shall certify in writing that it is ready to begin Acceptance Testing in accordance with the Acceptance Test Plan approved by the City and Appendix 6.

6.13 Biosolids Supply and Processing During Start-up and Testing. The plan for delivery and processing of City Biosolids and storage and disposal of Class A Product during start-up and testing shall be specified in the approved Acceptance Test Plan. PMA shall cause the Company to utilize or dispose of all Product produced in the conduct of start-up operations in accordance with the Contract Standards.

6.14 Conduct of Acceptance Test. Subject to the provisions of this Section, PMA shall cause the Company to conduct the Acceptance Test in accordance with Appendix 6 and the Acceptance Test Plan, and shall notify the City, in accordance with Section 6.12 C., when the test shall occur. PMA shall cause the Company to permit the City's designated representatives to inspect the preparations for the Acceptance Test and to be present for the conduct of the Acceptance Test

for purposes of ensuring compliance with the Acceptance Test plan and the integrity of the results of the Acceptance Test. The Company shall perform and provide all sampling and analysis required for Acceptance Testing.

6.15 ATSA Date Conditions. The following conditions shall constitute the Acceptance Test Standards Achievement Date Conditions (the "ATSA Date Conditions"), each of which must be satisfied by the Company in order for the ATSA Date to occur and each of which must be and remain satisfied as of the ATSA Date:

A. Construction Date Conditions. Each of the Construction Date conditions set forth in Section 6.2 B shall be and remain satisfied as of the ATSA Date;

B. Substantial Completion. PMA shall have caused the Company to have demonstrated that Substantial Completion has occurred;

C. Achievement of Acceptance Test Standards. PMA shall have caused the Company to have completed the required Acceptance Tests and such tests shall have demonstrated that the Class A Facilities have met the Acceptance Test Standards;

D. Final Operation and Maintenance Manual. PMA shall have caused the Company to have delivered to the City the final Class A Facilities Operation and Maintenance Manual in accordance with Appendix 8;

E. Required Operation Period Insurance. PMA shall have caused the Company to have submitted to PMA certificates of insurance for all Required Insurance applicable to the operation of the Class A Facilities as set forth in Appendix 12;

F. Operating Governmental Approvals. All applicable Governmental Approvals required under Applicable Law for the continued routine operation of the Class A Facilities shall have been duly obtained by the Company and shall be in full force and effect. Copies of all such Governmental Approvals, certified by the Company, shall have been delivered to the City;

G. Record Documents. The City shall have approved Company's schedule for delivery to the City a final and complete reproducible set of record documents;

H. Equipment Warranties and Manuals. PMA shall have caused the Company to be in possession of, and shall have delivered to the City, copies of the warranties of machinery, equipment, fixtures and vehicles constituting a part of the Class A Facilities, together with copies of all related operating manuals supplied by the equipment supplier; and

I. No Default. There shall be no Event of Default by PMA under this Service Contract or by the Company under the Service Agreement or by the Company's Guarantor under the Guaranty Agreement, or event which with the giving of notice or the passage of time would constitute an Event of Default by PMA hereunder or an Event of Default by the Company under the Service Agreement or Company's Guarantor under the Guaranty Agreement.

6.16 Test Report. Within thirty (30) days following conclusion of the Acceptance Test, PMA shall cause the Company shall furnish the City with ten copies of a certified written report describing and certifying (1) the Acceptance Tests conducted, (2) the results of the Acceptance Tests, and (3) the level of satisfaction of the Acceptance Test Standards and all other requirements specified in Appendix 6 and Appendix 7. The written test report shall include copies of the original data sheets, log sheets and all calculations used to determine performance during the applicable Acceptance Tests, and copies of laboratory reports conducted in conjunction with the applicable Acceptance Tests, including all laboratory sampling and test results.

6.17 Concurrence or Disagreement with Test Results.

A. ATSA Date Concurrence. Subject to Section 6.15, the ATSA Date shall be the day after the date upon which the Acceptance Test Standards have been achieved. If the Company certifies to PMA in its written report delivered pursuant to Section 6.16 that the full Acceptance Test Standards have been achieved, the City shall determine, within thirty (30) days of its receipt of such report, whether it concurs in such certification. If the City states in writing that it concurs with the Company's certification, the Class A Facilities shall be deemed to have achieved Acceptance Test Standards Achievement and the ATSA Date shall be deemed to have been established on a permanent basis from the date identified in the Company's original certification as the ATSA Date.

B. ATSA Date Disagreement. If the City determines at any time during such thirty (30) day review period that it does not concur with such certification by the Company, the City shall immediately send written notice to PMA and the Company of the basis for its disagreement. The parties will meet within seven days of the City's issuance of its notice of non-concurrence and attempt in good faith to resolve the issues. In the event the Company, in conducting the Acceptance Tests, does not successfully meet the Acceptance Test Standards, the Company shall re-test the Class A Facilities for compliance only with the Acceptance Test Standards not previously achieved through an earlier Acceptance Test.

6.18 Failure to Meet Acceptance Test Standards.

A. Event of Default. If, as of the fifth anniversary of the Service Contract Date, the Acceptance Tests have not been conducted or have failed to demonstrate that the Class A Facilities operates at a standard equal to or greater than those set forth in the Acceptance Test Standards, and if such failure is not the result of an Uncontrollable Circumstance or City Fault, an Event of Default by PMA will be deemed to have occurred under Section 10.2 A.

B. Extension Period. If the City has notified PMA of an Event of Default pursuant to Section 6.18 (A), PMA may promptly submit a plan to the City that provides reasonable assurances that PMA can meet the Acceptance Test Standards within six (6) months after the Event of Default (the "Extension Period"). At the City's sole option, PMA may be permitted to continue Acceptance Testing for the additional six (6) month period, provided that PMA shall pay to City the amount of One Hundred Thousand Dollars (\$100,000) on the first day of each month following the date of notification of Event of Default. PMA shall be responsible for any

finances or penalties owed to Governmental Bodies for compliance with Applicable Law due to PMA's delay in meeting Acceptance Test Standards.

C. Right of Termination. Subject to Section 6.18(D) and 6.18(E), if PMA has failed to cure its Event of Default under Section 6.18(A), or has failed to achieve compliance with the Acceptance Test Standards in the period set forth in Section 6.18(B) if applicable, and if such Event of Default or failure is not excused by an Uncontrollable Circumstance or City Fault, then not later than thirty (30) days after such Event of Default or end of the Extension Period, whichever is applicable, upon written notice the City may terminate the Service Contract or only those provisions of this Service Contract relating to the Class A Facilities and the Class A Period. The term for the Interim Period Services portion of this Service Contract may be extended for a time period to be determined by the City at its sole discretion, but which shall be not longer than two (2) years after termination of the Class A provisions of this Service Contract, after which time the Service Contract shall terminate. Upon termination of the Service Contract in accordance with this Section, PMA shall pay liquidated damages to the City in the amount of Three Million Dollars (\$3,000,000), minus any liquidated damages amounts paid by PMA under Section 6.18(B), and actual damages equal to the cost of demolition and removal of the Class A Facilities. Other than such payment of liquidated damages and the actual damages required by this Section by PMA, neither party shall have any further liability to the other in the event of termination by the City under this Section.

D. Adjustment to Service Fee. If PMA is unable to cause the Company demonstrate a Class A Facility production capacity of 65,000 Dry Tons of Dewatered City Biosolids consistent with the Acceptance Test Standards in Appendix 6, so long as the Class A Facility production capacity is 60,000 Dry Tons of Dewatered City Biosolids, the City shall accept the Class A Facilities with a reduction to the Fixed Capacity Charge component of the Service Fee:

(1) If the Class A Facility capacity falls between the range of 62,500 Dry Tons per year (216.4 Dry Tons per day) and 65,000 Dry Tons per year (225 Dry Tons per day) then the Fixed Capacity Charge as defined in Section 8.3 B (2) shall be permanently reduced by 1.5% for each 1.0% in Class A capacity as shown by the Acceptance Test.

(2) If the Class A Facility capacity falls between the range of 60,000 Dry Tons per year (208 Dry Tons per day) and 62,499 Dry Tons per year (216.4 Dry Tons per day) then the Fixed Capacity Charge as defined in Section 8.3 B (2) shall be permanently reduced by 2.0% for each 1.0% in Class A capacity as shown by the Acceptance Test.

E. If PMA is unable to cause the Company to demonstrate a Class A Facility production capacity of 65,000 Dry Tons of Dewatered City Biosolids consistent with the Acceptance Test Standards in Appendix 6 and the Class A Facility production capacity is 59,999 Dry Tons per year or less, the City may, at its sole option, elect to accept the Class A Facilities with a reduction to the Fixed Capacity Charge that will be negotiated by the parties but will be no less of a reduction than that provided for in Section 6.18 D.(2). However, if the City does not so elect, this Agreement shall terminate in accordance with Section 6.18(A).

F. Lender Cure Rights. If the City has notified PMA of its termination of the Service Contract pursuant to Section 6.18 C., Lender may submit a plan to the City that provides reasonable assurances that Lender can meet the Acceptance Test Standards within a six (6) month period after the City's intended termination date. Lender shall then be entitled to continue Acceptance Testing for an additional six (6) month period.

6.20 Final Completion.

A. Requirements. The Company shall achieve Final Completion within sixty (60) days after the ATSA Date. "Final Completion" shall occur when all of the following conditions have been satisfied:

(1) Acceptance Test Standard Achievement. Acceptance Test Standards Achievement has occurred;

(2) Design/Build Work Completed. All applicable Design/Build Work (including all clean up and removal of construction materials and demolition debris) is complete and in all respects is in compliance with this Service Contract. Completion of the Final Punch List work shall have been verified by and signed off by the City at a final walk-through of the Class A Facilities conducted by the City, PMA and the Company;

(3) Spare Parts In Storage. All spare parts required by the Operation and Maintenance Manual and by applicable Design Requirements have been delivered and are in storage at the Operated Facilities;

(4) Deliverable Material Furnished. PMA has caused the Company to furnish to the City all Deliverable Material required to be delivered;

(5) Record Drawings. PMA has caused the Company to have delivered to PMA a final and complete reproducible set of record drawings, together with six copies thereof, in a size and form required by PMA and as required by the Design Requirements and shall certify that the Class A Facilities was constructed in accordance with the Design Requirements. The Company shall provide an electronic file in AutoCad/DXF format to the extent drawings are prepared in such format; and

(6) Equipment List, Warranties and Manuals. PMA has caused the Company to be in possession of, and shall have delivered to the City, a complete list of all equipment installed in and constituting a part of the Class A Facilities, along with copies of the warranties of machinery, equipment, fixtures and rolling stock constituting a part of Class A Facilities, together with copies of all related operating manuals supplied by the equipment supplier.

B. Final Certificate. PMA shall cause the Company to prepare and submit to the City as soon as practicable following the Acceptance Test, a certificate of the Company Contract Representative certifying that all the Design/Build Work has been completed in accordance herewith and with the Design Requirements.

6.21 No Waiver Or Release. Unless other provisions of this Service Contract specifically provide to the contrary, none of the following shall be construed as the City's acceptance of any Design/Build Work which is defective, incomplete, or otherwise not in compliance with this Service Agreement, as City's release of PMA from any obligation under this Service Contract, as the City's extension of the PMA's time for performance, as an estoppel against the City, or as the City's acceptance of any claim by the PMA:

- A. The City's payment to PMA or other person with respect to the Class A Facilities;
- B. The City's review of any drawings, submissions, punch lists, other documents, certifications, or Design/Build Work of the Company or any Subcontractor;
- C. The City's review of (or failure to prohibit) any construction applications, means, methods, techniques, sequences, or procedures for the Design/Build Work;
- D. The City's entry at any time on the BRC Site (including any area in which the Design/Build Work is being performed);
- E. Any inspection, testing, or approval of any Design/Build Work (whether finished or in progress) by the City or any other person;
- F. Unless otherwise specifically stated herein, the City's failure or any the City's consultant's failure to respond in writing to any notice or other communication of PMA or the Company.

6.22 No Service Fee Payment During Start-up and Testing. During start-up and Acceptance Testing, the City shall not pay the Class A Facilities Service Fee to PMA; however all Interim Services fees shall continue to be paid by the City.

ARTICLE 7

PERFORMANCE OF BIOSOLIDS SERVICES

7.1 Interface and Delivery/Ownership of City Biosolids.

A. City Interface. PMA shall perform the Biosolids Services in a manner which serves and complements the requirements of the City's water pollution control plants and the wastewater treatment services performed by the City and agrees that no provision hereof shall confer upon PMA any right the exercise of which may adversely affect the City's water pollution control plants or the ability of the City to perform its wastewater treatment services in a manner which serves the needs of the City in compliance with Applicable Law.

B. Delivery and Title to and Ownership of City Biosolids. City Biosolids shall be conveyed from the City's water pollution control plants to the Operated Facilities in liquid form. PMA shall cause the Company to assume ownership and title to, and risk of damage or injury with respect to, the City Biosolids immediately upon such delivery. Notwithstanding the foregoing, (i) the Company expressly does not take title to biosolids classified as Hazardous under Applicable Law and (ii) Company expressly preserves its right to recover Loss-and Expense, Reimbursable Costs and Reimbursable Expenses as set forth in Section 7.5(A).

C. Minimum Quantity Guarantee. The City will not be responsible for delivering more than the minimum quantity of 49,000 Dry Tons of City Biosolids to the Operated Facilities; however the City warrants and represents that the City shall deliver all City Biosolids exclusively to PMA at the Operated Facilities during the Term of this Service Contract. Other than the minimum requirement stated herein, the City shall not be liable for damages or otherwise for any failure to deliver or cause to be delivered any particular quantity of City Biosolids to the Operated Facilities (subject to the PMA's rights to recover Reimbursable Costs).

7.2 Performance Standards and Guarantees. PMA shall cause the Company, except to the extent excused by Uncontrollable Circumstances or City Fault, to perform the Biosolids Services in compliance with the Performance Standards and Performance Guarantees set forth in Appendix 7.

7.3 Non-Compliance with Performance Guarantees.

A. Compliance with Performance Guarantees. The City may at any time it possesses reasonable cause to believe that PMA is not causing the Company to perform in accordance with the Performance Guarantees, require PMA to cause the Company to provide reasonable assurances of compliance.

(1) Operated Facilities Performance. The City may, upon reasonable advance notice, require that PMA cause a performance test to be conducted by the Company, at the City's cost and expense, to demonstrate that the Operated Facilities are operating in compliance with

Applicable Law and the Performance Guarantees. The performance tests shall be conducted in the same manner as provided for the Acceptance Tests in Appendix 6. If the test is successfully passed, the City shall reimburse PMA for all additional expenses, damages and losses, including but not limited to additional wages and salaries, arising out of the test or downtime needed to perform the test. If the test is not successfully passed, PMA shall cause the Company in a timely manner to perform its obligations under Section 7.3 B. and the test shall be re-performed at the Company's sole cost. The City Engineer will verify each test and inspection.

B. Remedies. PMA shall cause the Company to at all times comply with the Performance Guarantees, except to the extent compliance is prevented or excused by Uncontrollable Circumstances or City Fault. If the Company fails to comply with any Performance Guarantee and is not prevented or otherwise excused from performance, the Company shall: (1) promptly notify the City within 24 hours of the Company's having knowledge of any such non-compliance; (2) promptly provide the the City within 24 hours with copies of any notices sent to or received from any Governmental Body having regulatory jurisdiction with respect to any violations of Applicable Law; (3) pay any resulting direct damages, fines, judgments or award, including liquidated damages, levies, assessments, impositions, penalties or other charges resulting therefrom; (4) at its own cost and expense, take any commercially practicable action (including, without limitation, making repairs, replacements and operating and management practices changes) necessary, in light of the nature, extent and repetitiveness of such non-compliance, in order to comply with such Performance Guarantee, to continue or resume performance hereunder and eliminate the cause of, and to reasonably assure that such non-compliance will not recur; (5) promptly prepare all public notifications required by Applicable Law, and submit such notifications to the City for publication; and (6) assist the the City with all public relations matters necessary to adequately address any public concern caused by such non-compliance, including, but not limited to, preparation of press releases, attendance at press conferences, and participation in public information sessions and meetings.

7.4 Nonperformance Credits. Except to the extent that PMA is relieved due to an occurrence of an Uncontrollable Circumstance or City Fault, the City shall reduce the Service Fee as set forth in Section 8.3 for Company's failure to comply with the applicable Performance Guarantees.

7.5 Nonconforming City Biosolids.

A. Nonconforming City Biosolids. In the event that the City becomes aware that it has, is or is about to deliver Nonconforming City Biosolids to Company, it shall promptly notify PMA and the Company. In the event that Nonconforming City Biosolids are delivered to the Operated Facilities, the Reimbursable Costs of PMA shall be paid as set forth in Section 8.5. PMA shall cause the Company to use commercially reasonable efforts to process such Nonconforming City Biosolids into Class B Product during the Interim Period and into Class A Product during the Class A Period, in accordance with the Performance Guarantees. If Nonconforming City Biosolids are delivered to the Operated Facilities and are processed by Company and land applied in accordance with this Service Contract prior to the Company having, or prior to the time that Company reasonably should have had, knowledge that the biosolids were Nonconforming City Biosolids, then Loss-and-Expense, Reimbursable Costs and Reimbursable

Expenses shall be paid by PMA to PMA for any actions or fines brought against PMA or the Company by reason of the land application or disposal of Nonconforming City Biosolids.

B. Disposal of Hazardous Materials. In the event that any biosolids received from the City at the Operated Facilities is classified as Hazardous under Applicable Law, PMA shall cause the Company to immediately isolate such biosolids and give immediate notice of such discovery to PMA and all other appropriate Governmental Bodies as required by Applicable Law. Company shall, in the most expeditious manner possible under the circumstances and in accordance with Applicable Law take all appropriate actions relative to such Hazardous Substances. The additional costs incurred by PMA pursuant to this subsection shall be reimbursed by the City as Reimbursable Costs.

7.6 Product Utilization and Marketing.

A. Marketing Plan. Appendix 9 sets forth the requirements of the Marketing Plan for the Interim Period and the Class A Facilities Period.

B. Product Sampling, Testing and Tracking. PMA shall cause the Company to test and track the distribution of Product as and to the extent required by Applicable Law and the provisions of this Service Contract.

C. Applicable Law Compliance. PMA shall cause the Company to comply with any licensing, registration, labeling and other requirements which may be applicable to the production, processing, packaging, distribution, marketing and sale of Product under Applicable Law and shall not ship any Product that does not meet the requirements of Applicable Law.

7.7 Storage of Product.

A. On-Site Product Storage. PMA shall prohibit the Company from storing Product at the BRC Site unless such storage shall be expressly authorized under this Service Contract and any such storage shall be in accordance with the requirements and limitations of this Service Contract (including Appendix 2, 8, and 9) and Applicable Law.

B. Off-Site Product Storage. Storage outside the BRC Site shall be limited so as not to cause nuisance conditions in the community (including occupants of adjacent properties) and shall be in accordance with Applicable Law.

7.8 Disposal of Product.

A. Acceptable Disposal Site. All Product and any waste materials generated in PMA's performance of the Biosolids Services that is disposed of by Company shall be disposed of at an Acceptable Disposal Site in accordance with Applicable Law, the Performance Guarantees and the terms and conditions of this Service Contract. An "Acceptable Disposal Site," as used herein, means either a sanitary landfill, land application site, sludge incinerator, municipal solid waste incinerator or other lawfully authorized disposal facility for non-hazardous waste which: (1) is located in the United States; and (2) does not appear on any federal or state list of sites,

such as but not limited to the National Priority List or the CERCLIS list under CERCLA, which list is maintained for the purpose of designating landfills or other sites which are reasonably expected to require remediation on account of the release or threat of release of Hazardous Materials.

B. Acceptable Disposal Site Information. PMA shall cause the Company to keep and maintain such logs, records, manifests, bills of lading or other documents as the PMA may deem to be necessary or appropriate to comply with Governmental Approvals and to monitor and confirm compliance by the Company with the requirements of this Section, and shall collect and promptly provide the the City with a copy of all weights and measures data and information provided to the Company by the owner or operator of any Acceptable Disposal Site.

ARTICLE 8

SERVICE FEE

8.1 Service Fee Generally.

A. Payment by City. Commencing with the first Billing Period after the Commencement Date and for each Billing Period thereafter, the City shall pay PMA the Service Fee as full and exclusive compensation for the PMA's performance of the Biosolids Services and all other obligations of PMA under this Service Contract. The Service Fee shall be computed and paid in accordance with this Article 8.

B. Guaranteed Quantities of City Biosolids. As set forth in Section 7.1C. and subject to the conditions herein, the City shall have the obligation to deliver a minimum amount of 49,000 Dry Tons of City Biosolids to the BRC Site during each Contract Year. Even if the quantity of City Biosolids delivered to the BRC site falls below 49,000 Dry Tons, the City shall pay the Fixed Capacity Charge and the Fixed Operating Charge Components of the Class A Service Fee each month throughout the term of the Service Agreement applicable to not less than 49,000 Dry Tons. However, should the quantity of City Biosolids be significantly and permanently reduced from the expected delivery of 70,000 Dry Tons per Contract Year, so long as the level has not fallen below 49,000, the City and PMA may mutually agree to adjust the impacted components of the Fixed Operating Charge Components of the Class A Service Fee.

C. Economic and Pro Rata Adjustments. The Service Fee shall be adjusted on an annual basis to reflect economic factors in accordance with Section 8.4. Any computation to be made on the basis of a stated period shall be adjusted on a pro rata basis to take into account any partial period.

D. PMA Budgeting. No later than ninety (90) days prior to each Contract Year or earlier, if requested by the City, PMA shall cause the Company to provide to the City, for its budgeting purposes, a written statement of the estimated Service Fee (including each component thereof) for each month of such upcoming Contract Year. Such estimates shall not be binding on the City or PMA.

8.2 Interim Service Fee. From the Commencement Date and throughout the Interim Period, the City shall pay PMA on a monthly basis and in arrears the amounts set forth in this Section (the "Interim Service Fee").

A Formula. The Interim Service Fee shall be calculated in accordance with the following formula:

$$\text{ISF} = \text{FD/U} + \text{IC} + \text{MS} - \text{MC} + \text{RC}$$

where,

ISF	=	Interim Service Fee
FD/U	=	Fixed Dewatering/Utilization Charge
IC	=	Interim Period Insurance Costs
MS	=	Materials Service
MC	=	Miscellaneous Credits
RC	=	Reimbursable Costs

B. Components of Interim Service Fee.

(1) Fixed Dewatering/Utilization Charge. The Fixed Dewatering/Utilization Charge ("FD/U") shall be an amount equal to \$1,605,820 per Billing Period during the Interim Period, subject to adjustment as set forth in Section 8.4 A.

(a) Excess Dewatering/Utilization Charge. If PMA processes more than 63,000 Dry Tons of Dewatered City Biosolids during a Contract Year, the Excess Dewatering/Utilization Charge shall equal each Dry Ton of Dewatered City Biosolids processed during the prior Contract Year above 63,000 Dry Tons multiplied by Two Hundred Fifty Dollars (\$250), subject to adjustment as set forth in Section 8.4 A. PMA shall cause Company to perform an annual accounting of the Dewatered City Biosolids within thirty (30) days of the end of the Contract Year and provide that accounting to the City. The Excess Dewatering/Utilization Charge, if any, for the Contract Year shall be divided into four (4) equal amounts and added to the Service Fee for the third through sixth Billing Periods of the following Contract Year.

(2) Interim Period Insurance Costs. The Interim Period Insurance Costs ("IC") for each Billing Period shall be an amount equal to one-twelfth of PMA's Subcontractor's annual costs for providing the Required Insurance during the applicable Contract Year of the Interim Period, provided that such costs to be paid by the City shall not exceed Two Hundred Thousand Dollars (\$200,000) per Contract Year. Such costs shall not be subject to mark-up by PMA and shall be subject to approval by the City not later than sixty (60) days prior to the Contract Year in which such amount will be charged to the City. PMA shall cause the Company to be responsible for any deductibles without reimbursement by PMA or the City. If any increase in such costs of insurance are attributable to PMA's non-compliance with this Service Contract or with the provisions of the respective insurance policies, such increased costs shall not be reimbursed by the City. If requested by City, PMA shall cause the Company to submit in a timely manner insurance cost proposals in response to variations in the Insurance Requirements as may be specified by the City from time to time.

(3) Materials Service

(a) Unscreened Compost. Unscreened Compost on the BRC Site at the Commencement Date shall be measured by a qualified third-party expert. The total Tons of Unscreened Compost shall not exceed 55,000 Wet Tons, provided that any Unscreened Compost in excess of such 55,000 amount ("Excess Unscreened Compost") shall be treated as remaining Class B Biosolids. PMA shall pay Company Four Dollars (\$4.00) for each Wet Ton of Unscreened Compost. Company shall invoice PMA at a rate of one thirty-sixth (1/36) of the total amount due during each month of the Interim Period or until all Unscreened Compost has been removed, at which time, PMA shall invoice the City for all unbilled tonnage.

(b) Class B Biosolids and Excess Unscreened Compost. Class B Biosolids remaining on the BRC Site at the Commencement Date shall be measured by a qualified third-party expert. The City shall pay PMA Fifty One Dollars and Thirty Cents (\$51.30) for each Wet Ton of such remaining Class B Biosolids and for each Wet Ton of any Excess Unscreened Compost. PMA shall invoice the City at a rate of one third (1/3) of the total amount for Class B Biosolids for the first three months of the Interim Period, and PMA shall invoice the City at a rate of one-thirty sixth (1/36) of the total amount for Excess Unscreened Compost during each month of the Interim Period, or until all Excess Unscreened Compost has been removed, at which time PMA shall invoice the City for all unbilled tonnage.

(c) Screened Compost. The City shall pay PMA Three Dollars (\$3.00) for each Wet Ton of Screened Compost that is loaded onto a truck at the direction of the City or otherwise is removed from the BRC Site.

(d) Generator Fees. The City shall pay for all generator fees up to Ninety Three Thousand Dollars (\$93,000) per year, subject to an annual adjustment provided in 8.4.A. All excess generator fees over Ninety Three Thousand Dollars (\$93,000) per year shall be paid by PMA.

(e) Reimbursable Costs from Assigned Contracts. The City shall reimburse PMA for all approved costs from assigned subcontracts listed in Appendix 15 relating to soil testing and liming for pH adjustment, tissue analysis and other regulatory imposed testing, subject to City reimbursement under the City's assigned subcontracts.

(4) Miscellaneous Credits ("MC").

(a) Nonperformance Credits. PMA shall cause the Company to perform an annual accounting of the Nonperformance Credits that have accrued to the City during each Contract Year within thirty (30) days of the end of the Contract Year. The total MC for the Contract Year shall be divided into four (4) equal amounts and applied to the Service Fee for the third through sixth Billing Periods of the following Contract Year.

City-PMA Service Contract

(i) Return Flow #1 Capture Credit. This credit shall equal Seventy Five Dollars (\$75.00) per Dry Ton for the Dry Tons of suspended solids returned to the SWWPCP in excess of the Company's Return Flow #1 Guarantee as described in Appendix 7.

(ii) Excess Total Suspended Solids Credit. This credit shall equal Seventy-Five Dollars (\$75.00) per Dry Ton for the Dry Tons of suspended solids returned to the SWWPCP in excess of Five Thousand Four Hundred Seventy Five (5,475) Dry Tons per Contract Year.

(b) Dewatering/Utilization Credit. If PMA processes less than 57,000 Dry Tons of Dewatered City Biosolids during a Contract Year in the Interim Period, this credit shall equal each Dry Ton of Dewatered City Biosolids during such Contract Year below 57,000 Dry Tons multiplied by Two Hundred Dollars (\$200). This credit shall be adjusted on an annual basis under Section 8.4 (A).

(c) Utility Reimbursement Credit. PMA shall reimburse the City for actual gas and electric consumption used at the BRC Site at the rate paid for such utilities by the City. The Utility Reimbursement Credit shall be issued for each Billing Period for the prior month's utility consumption.

(5) Reimbursable Costs. The Reimbursable Costs ("RC") for each Billing Period, if any, may include amounts payable by the City under this Service Contract for increased operation, maintenance, utilization, disposal, or other costs incurred by the PMA on account of: (i) Nonconforming City Biosolids; (ii) an Uncontrollable Circumstance, net of any operation, maintenance or other cost savings achieved by the Company in mitigating the effects of such Uncontrollable Circumstance; and (iii) handling and disposal of City Biosolids classified as Hazardous under Applicable Law. Any such Reimbursable Costs shall be determined in strict accordance with the requirements set forth in Section 8.5.

8.3 Class A Service Fee. From and after the ATSA Date and throughout the Class A Period, the City shall pay PMA the amounts set forth in this Section (the "Class A Service Fee"), provided that the City shall pay the costs of natural gas and electricity incurred by the operation of the Existing Facilities and Class A Facilities.

A. Formula. The Class A Service Fee shall be calculated in accordance with the following formula:

$$ASF = FCC + PTC + FOC + VOC - MC + PEI + RC$$

where,

ASF	=	Class A Service Fee
FCC	=	Fixed Capacity Charge
PTC	=	Pass Through Costs
FOC	=	Fixed Operating Charge
VOC	=	Variable Operating Charge
MC	=	Miscellaneous Credits
PEI	=	Processing Efficiency Incentive
RC	=	Reimbursable Costs

B. Class A Service Fee Components.

(1) Fixed Design Build Price

(a) The Fixed capital costs for the Design/Build Work is Sixty-Six Million One Hundred Twenty Five Thousand Dollars (\$66,125,000) (the "Fixed Design Build Price") as detailed in Attachment 8.1. For purposes of determining the Fixed Capacity Charge, the Fixed Design/Build Price is assumed to be financed by the Company using project financing totaling Fifty Nine Million One Hundred Twenty Five Thousand Dollars (\$59,125,000) (the "Project Financing"), and other capital totaling Seven Million Dollars (\$7,000,000) ("Additional Capital"). The Fixed Design Build price and Project Financing are subject to escalation as set forth in Section 8.4.

(2) Fixed Capacity Charge.

(a) The Fixed Capacity Charge ("FCC") per Contract Year shall be the amount calculated as the sum of:

(i) Subject to Section 8.3B.(2)(d), the net annual debt service amount which would be payable on the Project Financing necessary to fully amortize such Project Financing amount to a zero balance over a 20 year term assuming: (1) an initial principal amount outstanding equal to the amount of the Project Financing, and (2) a fixed interest using the actual stated interest rate (or weighted average fixed interest rate if multiple series of debt at different rates are issued) on debt entered into by the Company to finance the Design/Build Work at the Financial Close Date, and

(ii) the annual amount of Eight Hundred Forty Thousand Dollars (\$840,000) as a return on Company's equity investment.

(iii) The annual debt service amount calculated under Section 8.3B.(2)(a)(i) assumes a fixed rate of interest and a level annual debt

service based on “mortgage-style” amortization of principal over twenty (20) years for the Project Financing.

Variable Rate Financing. The Company may elect to use a variable rate of interest for the Project Financing. If such variable rate Project Financing is issued or secured by the Company, then both the FCC and the interest rate it is based on shall remain fixed during the Class A period regardless of the changes in the actual variable rate of interest. The fixed interest rate specified in Section 8.3B.(2)(a)(i) will be the fixed rate in the Bond Buyer “20-Bond Index” published in The Bond Buyer or its successors on the date closest to the Financial Close Date. The Company must demonstrate to PMA, in advance of Company’s closing on any such financing that Company’s variable rate financing payment shall amortize the Project Financing over a twenty (20) year term and shall always result in an outstanding Project Financing balance that is equal to or less than the Project Financing balance that would result from applying the Bond Buyer “20-Bond Index” rate to a twenty (20) year level-payment self-amortizing debt service. The cost of credit enhancements, interest rate swap arrangements and all other financing fees (“Financing Fees”) shall be paid by the Company. To the extent commercially reasonable, the Financing Fees shall be paid by the Company on or prior to the Financial Close Date. Under no circumstances shall the City pay for or reimburse the PMA for additional Financing Fees incurred by the Company after the Financial Close Date.

(b) Project Financing shall include a debt service reserve fund equal to one (1) year of debt service payments as calculated in Section 8.3B.(2)(a)(i) . During each Contract Year the interest earnings on the actual funds included in the debt service reserve fund shall accrue and shall be treated as a Miscellaneous Credit as defined in Section 8.4 B.(6).

(i) The use of proceeds and other constraints for the Project Financing shall be in accordance with the Financing Plan set forth in Appendix 11 and any variation shall be subject to written City approval prior to or on the Financial Close Date.

(c) For each Billing Period, the FCC shall be paid by the City in an amount equal to the FCC amount per Contract Year divided by twelve.

(d) If the FCC as calculated pursuant to section 8.3B (2)(a) is in excess of Six Million Three Hundred Thousand Dollars (\$6,300,000) per Contract Year (whether the Project Financing is arranged on a taxable or tax-exempt basis and regardless of what may cause such amount to be exceeded), then the City may immediately terminate the provisions of this Service Contract concerning the

Class A Facilities and the Class A Period. Notwithstanding the foregoing, should the Company agree to accept Six Million Three Hundred Thousand Dollars (\$6,300,000) per Contract Year as its FCC, then the City shall not have the right to terminate the Service Contract unless the actual FCC exceeds a total of Six Million Six Hundred Thousand Dollars (\$6,600,000). Upon such termination, the PMA shall continue to provide the Interim Services for such period as is set forth in Section 5.2(B)(2). Not later than ninety (90) days after such termination, the City shall pay to PMA the Reimbursable Expenses of the Company, but not to exceed the amount of Two Million Five Hundred Thousand Dollars (\$2,500,000), and the City shall have no further liability to PMA.

(e) The FCC shall be reduced to Eight Hundred Forty Thousand Dollars (\$840,000) starting when the amount of funds available in the debt service reserve fund established for such Project Financing is sufficient to redeem the outstanding principal amount of the Project Financing and such payment amount of Eight Hundred Forty Thousand Dollars (\$840,000) shall end upon expiration of the Initial Term.

(f) During any Renewal Term the FCC shall be Eight Hundred Thousand Dollars (\$800,000) annually to compensate PMA for Renewal and Replacement. Such amount shall be subject to adjustment as outlined in Section 8.4 D.

(3) Pass Through Costs. The following costs as actually incurred by the PMA shall be paid by the City each Billing Period and no markup for indirect costs or profit may be added by PMA:

(a) Insurance costs in an amount equal to one-twelfth of the PMA's Subcontractors' annual costs for providing the Required Insurance during the applicable Contract Year of the Class A Period. Such costs of insurance must be approved in advance by the City not later than sixty (60) days prior to the Contract Year in which such amount will be charged to the PMA. PMA shall cause the Company to be responsible for any deductibles without reimbursement by PMA or the City. If any increase in such costs of insurance are attributable to PMA non-compliance with this Service Contract or the provisions of the respective insurance policies, such increased costs shall not be reimbursed by the City. If requested by the City, PMA shall cause the Company to submit in a timely manner insurance cost proposals in response to variations in the Insurance Requirements as may be specified by PMA from time to time; and

(b) Property and business use and occupancy taxes, if any, paid to the City during the applicable Contract Year of the Class A Period.

(4) Fixed Operating Charge. The Fixed Operating Charge ("FOC") shall be an amount equal to Five Hundred Seventy-Nine Thousand One Hundred Sixty Six Dollars

(\$579,166) per Billing Period during the Class A Period, subject to adjustment as set forth in Section 8.4 C.

(5) Variable Operating Charge.

(a) The Variable Operating Charge ("VOC") shall be an amount equal to Seventy Five Dollars and Ninety Three Cents (\$75.92) per Dry Ton of Dewatered City Biosolids processed into Product at the BRC Site for each Billing Period during the Class A Period, provided that such unit price shall be reduced by the amount of Eight Dollars and Fifty Cents (\$8.50) per Dry Ton Dewatered City Biosolids at such time that direct rail service is provided at the BRC Site. Both prices are subject to the adjustments as set forth in Section 8.4 C.

(b) The VOC for Dry Tons of Dewatered City Biosolids above Sixty Three Thousand (63,000) Dry Tons of Dewatered Biosolids per year shall be One Hundred Three Dollars and Seventy-Five Cents (\$103.75).

(6) Miscellaneous Credits. The Class A Service Fee payable by the City shall be reduced by Miscellaneous Credits ("MC") due to the City. PMA shall cause the Company shall perform an annual accounting of the MC that has accrued during each Contract Year within forty-five (45) days of the end of the Contract Year. The total Miscellaneous Credits for the Contract Year shall be divided into four (4) equal amounts and applied to the Service Fee for the third through sixth Billing Periods of the following Contract year.

(a) Interest Earnings on Debt Service Reserve Fund. During each Contract Year the actual interest earnings on the actual funds included in the Debt Service Reserve Fund shall accrue to the benefit of the City and applied as Miscellaneous Credits.

(b) Nonperformance Credits.

(i) Class A Facility Nonperformance Credit. This credit shall equal the Dry Tons in excess of 4,000 Dry Tons of Dewatered City Biosolids not processed into Class A Product and which is shipped off-site during any Contract Year multiplied by Ninety Dollars (\$90).

(ii) Natural Gas Credit. The credit shall equal the additional actual costs incurred by City for natural gas utilized by Company in the operation of the Existing Facilities and the Class A Facilities during each Contract Year due to Company's consumption of natural gas in excess of the Maximum Natural Gas Guarantee.

(iii) Digester Gas Credit. In the event the Company does not meet its Minimum Digester Gas Utilization Guarantee as outlined in Appendix 7, the following credit will apply: PMA will credit to the City the amount of Therms of Digester Gas below the Minimum Digester Gas Utilization Guarantee times 50% of the cost of Therms for Natural Gas due to the Company's failure to meet its Minimum Digester Gas Utilization Guarantee.

(iv) Electricity Credit. This credit shall equal the additional actual costs incurred by the City for electricity utilized by Company in the operation of the Existing Facilities and the Class A Facilities during each Contract Year due to Company's consumption in excess of the Maximum Power Guarantee;

(v) Return Flow #1 Capture Credit. This credit shall equal Seventy Five Dollars (\$75) per Dry Ton and one-half (1/2) the Maximum Electrical Power Guarantee per Dry Ton for the Dry Tons of suspended solids returned to the SWWPCP in excess of the Company's Return Flow #1 Guarantee as described in Appendix 7;

(vi) Excess Total Suspended Solids Credit – Class A. This credit shall equal Seventy Five Dollars (\$75.00) per Dry Ton for the Dry Tons of suspended solids returned to the SWWPCP in excess of 6,570 Dry Tons per Contract Year;

(vii) Excess Total Flow Credit. This Credit shall equal the annual flow discharged to SWWPCP utilized by the Company in the Class A Facilities, in excess of the average daily maximum flow rate of 3.5 MGD multiplied by the then current City charge for sewage treatment of wastewater at normal solids loading rate (Water Department Regulations, Sewer Charges, Section 302.3(B) Quantity charges, and as subsequently promulgated by the City).

(7) Processing Efficiency Incentive. The Processing Efficiency Incentive ("PEI") for each Contract Year, if any, shall be the sum of (a) the Electricity Utilization Savings, (b) the Natural Gas Utilization Savings or (c) the Alternative Fuel Utilization Savings, and (d) the Digester Gas Utilization Savings. The PEI for the Contract Year shall be divided into four (4) equal amounts and applied to the Service Fee for the third through sixth Billing Periods of the following Contract Year.

(a) Electricity Utilization Savings. If the total kilo-watt hours of electricity utilization at the BRC Site during a Contract Year is less than the Maximum Electrical Power Guarantee multiplied by the Dry Tons of Dewatered City Biosolids processed into Product for such Contract Year, then PMA shall be

entitled to an incentive payment (the "Electricity Utilization Savings") equal to fifteen percent (15%) of the difference in costs incurred by the City for electrical power at the BRC Site for the Contract Year between the Maximum Electrical Power Guarantee and the actual electricity utilized in such Contract Year;

(b) Natural Gas Utilization Savings. If total Therms of Natural Gas utilization at the BRC Site during a Contract Year is greater than the Maximum Natural Gas Guarantee multiplied by the Dry Tons of Dewatered City Biosolids processed into Product for such Contract Year, then the Natural Gas Utilization Savings shall be equal to zero. If the total Therms of Natural Gas at the BRC Site during a Contract Year is less than the Maximum Natural Gas Guarantee multiplied by the Dry Tons of Dewatered City Biosolids processed into Class A Product for such Contract Year, then PMA shall be entitled to an incentive payment (the "Natural Gas Utilization Savings") equal to fifteen percent (15%) of the difference in costs incurred by the City for Natural Gas at the BRC Site for the Contract Year between the Maximum Natural Gas Guarantee amount and the actual Natural Gas utilized in such Contract Year;

(c) Alternative Fuel Utilization Savings. If Alternative Fuel is utilized as a primary heat source for the Class A Facility, and Alternative Fuel utilization for the Class A Facilities during a Billing Period is greater than the Maximum Alternative Fuel Guarantee (as described in Appendix 7) amount, then the Alternative Fuel Utilization Savings shall be equal to zero. If the Alternative Fuel utilization for the Class A Facilities during a Billing Period is less than the Maximum Alternative Fuel Guarantee amount, then PMA shall be entitled to an incentive payment (the "Alternative Fuel Utilization Savings") equal to fifteen percent (15%) of the difference between the Maximum Alternative Fuel Guarantee amount and the actual Alternative Fuel utilized for the Class A Facilities in such Billing Period;

(d) Digester Gas Utilization Savings. If the utilization of Natural Gas or Alternative Fuel for the Class A Facilities is reduced in a Billing Period through the utilization of Digester Gas, then PMA shall be entitled to an incentive payment (the "Digester Gas Savings") equal to ten percent (10%) of the reduction in the amount of the costs for Natural Gas or Alternative Fuel incurred by the City for such Billing Period due to the replacement of Natural Gas or Alternative Fuel through such utilization of Digester Gas.

(8) Reimbursable Costs. The Reimbursable Costs ("RC") for each Billing Period, if any, may include amounts payable by the City under this Service Contract for increased operation, maintenance or other costs incurred by PMA during such Billing Period or a prior Billing Period on account of: (i) Nonconforming City Biosolids, (ii) an Uncontrollable Circumstance, net of any operation, maintenance or other cost savings achieved by the Company in mitigating the effects of such Uncontrollable Circumstance,

and (iii) handling and disposal of City Biosolids classified as Hazardous under Applicable Law. Any such Reimbursable Costs shall be determined in strict accordance with the requirements set forth in Section 8.5 and Cost Substantiation.

8.4 Economic and Quantity Adjustments.

A. Interim Service Fee. The Fixed Dewatering/Utilization Charge, the Excess Dewatering Utilization Charge and the Miscellaneous Credits shall be adjusted for each Contract Year during the Interim Period from July 1, 2005 to the first day of each Contract Year the following manner:

(1) 9% of the charge shall be adjusted by the change in the Department of Energy's Energy Information Administration publication of monthly Central Atlantic (PADDIPP) No.2 Diesel Retail Sales by all Sellers in the on-Highway Diesel Fuel Table.

(2) 91% of the charge shall be adjusted by the change in CPI Index ID # CUUR0100SAO – All Urban Consumers – Northeast United States.

B. Project Financing. The Project Financing shall be adjusted from January 1, 2006, to the Financial Close Date, or not later than 15 months after the Service Agreement Date (or such other date as established pursuant to Section 5.6 B.) whichever occurs earlier (after which no further adjustment under this Section 8.4 B. shall be made), in the following manner:

(1) Fixed Design/Build Price Adjustments. The following shall constitute the Fixed Design/Build Price Adjustments:

(a) An adjustment for the cost of any Change Orders issued by the City with respect to the Facility not due to PMA Fault;

(b) An adjustment for the cost of any Uncontrollable Circumstances consistent with Section 12.1; and

(c) Design/Build Cost Escalation as set forth in Section 8.4 B.(2), (3) and (4).

(2) Design/Build Escalation - Fixed Design Build Price

(a) The Fixed Design Build Price ("FDBP") for the Work is \$66,125,000 as of the January 1, 2006. The factors for escalation of the FDBP, in accordance with this Article, are set forth below.

(b) A revised FDBP will be delivered to PMA at the Construction Date or fifteen months, whichever is sooner, based on the *Engineering News Record/McGraw-Hill*, construction escalation indices as provided in Section 8.4B.(3).

(3) Design/Build Cost Escalation – Escalation Factors

(a) An adjustment factor will be applied to 10% of the FDBP associated with the steel materials portion of the FDBP. The adjustment will be based on the *Engineering News Record/McGraw-Hill, Material Cost Index for Steel*. The percentage change to the index value from January 1, 2006 to the Construction Date shall be used to adjust the FDBP.

(b) An adjustment factor will be applied to 45% of the FDBP associated with the Consumer Price Index ID#CUUR0100SAO –All Urban Consumers – Northeast United states. The percentage change to the index value from January 1, 2006, to the Construction Date shall be used to adjust the FDBP.

(c) The remaining 45% of the FDBP not adjusted in the specific material indices above shall be adjusted by applying the *ENR Construction Cost Increase (CCI) for the City of Philadelphia*. The percentage change to the index value from the January 1, 2006, to the Construction Date shall be used to adjust the FDBP.

(d) The total aggregate of all adjustments shall be utilized to the revise the FDBP as of the Construction Date. Under no circumstances shall the FDBP be less than \$66,125,000.

(4) Design/Build Cost Escalation – Escalation of the ASF. The FCC component of the ASF shall be adjusted to reflect the escalation to the FDBP as calculated in Section 8.4 B. above, and approved by the City effective the Construction Date.

C. Class A Service Fee Components. The Fixed Operating Charge, the Variable Operating Charge, and the Class A Facility Nonperformance Credit shall be adjusted for each Contract Year of the Class A Period from July 1, 2006, to the first day of the Contract Year in the following manner.

(1) 10% of the charge shall be adjusted by the change in the Department of Energy's Energy Information Administration publication of monthly Central Atlantic (PADDIPP) No.2 Diesel Retail Sales by all Sellers in the on-Highway Diesel Fuel Table;

(2) 15% based upon the change in PPI Index ID# PCU325211325211 Plastics Material and Resins Manufacturing;

(3) 75% of the charge shall be adjusted by the change in CPI Index ID#CUUR0100SA0 – All Urban Consumers – Northeast United States.

D. Renewal Period. 100% of the FCC for the renewal period, as defined in Section 8.3 B.(2)(f) shall be adjusted by the change in CPI Index ID # CUUR0100SA0 – All Urban Consumers – Northeast United States.

8.5 Reimbursable Costs.

A. Prior Approval Required. Unless it is impractical or impossible to do so, any costs for which PMA intends to obtain payment from the City as Reimbursable Costs shall be subject to the written approval of the City before such costs are incurred by PMA or its Subcontractors. In requesting such approval, PMA shall cause the Company to submit a written proposal setting forth the scope of its intended actions, estimates or firm commitments for the costs to be incurred, reference to the express provisions of this Service Contract that may authorize PMA to bill the City for such costs as Reimbursable Costs, and such additional information and documentation that the City may require.

B. Allowable Markups. PMA may add markups to Reimbursable Costs as set forth in this Section. Costs for Design/Build Work may be marked up by PMA at the rate of 10% for wage and benefit costs of Company's employees and at the rate of 8% for non-affiliated Subcontractors or other third-party vendors or suppliers. Costs that are not for the Design/Build Work, such as operations, utilization, and disposal costs, may be marked up by PMA at the rate of 10% for wage and benefit costs of Company employees and at the rate of 8% for costs of non-affiliated Subcontractors or other third-party vendors or suppliers. PMA markup for any work, services or supplies provided by an Affiliate of the Company, Members of the Company, or Subcontractors shall be limited to 3% and shall be subject to prior written approval by the City. Subcontractors at any tier shall be limited to the markups set forth in this Section with respect to its costs.

8.6 Payment of the Service Fee.

A. The Fixed Dewatering/Utilization Charge of the Interim Service Fee shall not be subject to dispute and PMA shall invoice the City for the Fixed Dewatering/Utilization on or after the last day of each calendar month during the Interim Period and continuing throughout the Interim Period, except as may be otherwise provided in this Service Contract. All other components of the Interim Service Fee shall be paid in accordance with the procedure outlined in Section 8.6 D.

B. The Fixed Capacity Charge of the Class A Service Fee shall not be subject to dispute and shall be due and payable by the City on or before the first day of each calendar month during the Class A Period and continuing for 240 consecutive months except as may be otherwise provided in this Service Contract.

C. The Fixed Operating Charge Components of the Class A Service Fee shall not be subject to dispute and PMA shall invoice the City for the Fixed Operating Charge Components of the Class A Service Fee on or after the last day of each calendar month during the Class A Period.

D. Those portions of the Interim Service Fee and the Class A Service Fee not billed under Section 8.6A., 8.6 B. or 8.6 C., shall be paid by the City based on billing statements provided by PMA for each Billing Period. The Service Fee for each month shall be on account of the Biosolids Services rendered during the prior month. The City shall review each billing statement within ten (10) working days of receipt to determine accuracy and conformance with the applicable provisions of this Service Contract. If the billing statement is acceptable, the City shall pay the amount of the billing statement within thirty (30) days of receipt.

8.7 Billing Statement Disputes. If the City and PMA are not able within thirty (30) days of receipt of billing statement to resolve a discrepancy identified by the City in a billing statement, then the City shall pay the undisputed amount when originally due and provide PMA with a written objection indicating the amount that is being disputed and providing all reasons then known to the City for its objection to such amount. When any such billing dispute is finally resolved, the City shall make payment to the Company within thirty (30) days of the date of resolution.

ARTICLE 9

SERVICE COORDINATION AND CONTRACT ADMINISTRATION

9.1 Facility Manager. PMA shall cause the Company to appoint and train a manager for the Operated Facilities (the "Facility Manager"). The Facility Manager shall be a full time position located at the BRC Site hired at least thirty (30) days prior to the Commencement Date, and shall be trained in the operations of facilities similar to the Operated Facilities, so as to be proficient in the operations of the Operated Facilities. PMA shall cause the Company to provide the City with documentation evidencing the fact that the Facility Manager possesses such skills. The Company shall keep the City informed at all times of the identity of the person serving from time to time as Facility Manager, provided, however, that any individual serving as Facility Manager shall, prior to assuming such responsibility, demonstrate that the individual is proficient in the operations of the Operated Facilities. The Company shall provide the telephone and fax numbers and other means by which the Facility Manager may be contacted at the BRC Site, together with the telephone or beeper number at which a responsible Company official can be contacted at all times in the event of an emergency.

9.2 Senior Supervisor. PMA shall cause the Company to inform the City of the identity of the officials of the Company and the Company's Guarantor with senior supervisory responsibility for the Company's performance of the Biosolids Services from time to time (the "Senior Supervisors"), and of the telephone and fax numbers and other means by which such persons may be contacted.

9.3 Service Agreement Administration.

A. Contract Representative. The City shall designate and PMA shall cause the Company to designate in writing by the Commencement Date a person to transmit instructions, receive information and otherwise coordinate service matters arising pursuant to this Service Contract (each, a "Contract Representative"). Either party may designate a successor or substitute Contract Representative at any time by written notice to the other party. The Company's Contract Representative shall be intimately familiar with the full range of the Biosolids Services, including the day-to-day operation activities of the Operated Facilities and the Design/Build Work, and shall be in regular communication with the Facility Manager.

B. Company Monthly Meeting Attendance Required. PMA shall cause the Company to meet with the City each month to review the contents of the monthly reports required to be prepared pursuant to this Service Contract. The Facility Manager and, if requested by the City, the Senior Supervisors each shall personally attend the monthly operations meetings with the City, and all other City meetings which the City may reasonably request, to review management, operational, performance and planning matters arising out of this Service Contract. Any issue in dispute which the parties are unable to resolve at such monthly and any special meetings may be referred to Non-Binding Mediation, and the resolution of any issue resolved at such meetings or through Non-Binding Mediation shall be reflected in a Contract Administration Memorandum.

C Contract Administration Memoranda. The principal formal tool for the administration of matters arising under this Service Contract between the parties shall be a memorandum which shall be prepared, once all preliminary communications have been concluded, to evidence the resolution reached by the City and PMA as to matters of interpretation and application arising during the course of the performance of their obligations hereunder (the "Contract Administration Memorandum").

(1) Procedures. The Contract Administration Memorandum shall be prepared by the City and shall be dated and signed by the Contract Representative of each party, and signed by the City and by PMA. The Contract Administration Memorandum shall additionally be signed by the Company.

(2) Effect. Executed Contract Administration Memoranda shall serve to guide the ongoing interpretation of this Service Contract. Notwithstanding the foregoing, in the event of a conflict between Contract Administration Memoranda and this Service Contract, the Service Contract shall control. Moreover, any material change, alteration, revision or modification of this Service Contract shall be effectuated only through a formal written Service Contract amendment authorized, approved or ratified by resolution of PMA and properly authorized by the City.

9.4 Facility Records.

A. City Access to Facility Records. PMA shall cause the Company to make available to the City all operations, maintenance, performance and distribution data, documents and records relating to the Operated Facilities.

B. Financial Books and Records. PMA shall, and shall cause the Company, to prepare and maintain proper, accurate, complete and current financial books, records and accounts, in accordance with generally accepted accounting principles consistently applied. These financial records shall be in form and substance sufficient to support all financial reporting, including Cost Substantiation, required hereunder. In the event PMA or the Company fails to prepare or maintain any books, records or accounts as required under this Section, the PMA shall not be entitled to any requested payments or adjustments for which Cost Substantiation was required hereunder to the extent such failure prevented Cost Substantiation. PMA shall and shall cause the Company to keep the books, records and accounts maintained with respect to each Contract Year for five years after the end of the Term, or such longer period as may be appropriate to account for any dispute then pending or as required by Applicable Law. For those circumstances that require Cost Substantiation PMA and the Company shall make such books and records available to the City for inspection, audit and copying upon reasonable notice during business hours to the extent necessary to allow the City to determine to its reasonable satisfaction the accuracy, completeness, currency and propriety of any charge or request for payment hereunder. The provisions of this Section shall survive the termination of this Service Contract.

C Financial Reports. PMA shall cause the Company to promptly furnish the City with any copies of the annual and other periodic financial reports of the Company's Guarantor.

D. City Inspection Right, Audit and Adjustment. The City shall have the right to perform or commission an inspection or an independent audit of the financial information required to be kept under this Section, subject to possible reimbursement as provided in this Section. If an inspection or audit contemplated by this Section discloses a Billing Statement that either (i) overstates City payment amounts by more than 1% of the proper amount or (ii) understates City Credit Amounts by more than 1% of the proper amount, then PMA shall, in addition to the reimbursement or credit of such overstated (or understated) City payment amounts or City credit amounts, as applicable, with respect to such Billing Statement, with interest, reimburse the City for any and all fees and costs incurred in connection with the inspection or audit. The foregoing remedies shall be in addition to any other remedies the City may have under this Service Contract or Applicable Law.

9.5 Periodic Reports.

A. Monthly Reports. PMA shall cause the Company to provide the City with monthly operations reports no later than fifteen (15) days after the end of each month.

B Annual Reports. PMA shall cause the Company to furnish to the City, within sixty (60) days after the end of each Contract Year, the Annual Report with an annual summary of the information and statistical data provided in the monthly reports and such information as may be reasonably requested by the City.

ARTICLE 10

BREACH, DEFAULT, TERMINATION, AND DISPUTE RESOLUTION

10.1 Remedies For Breach. Except where damages for specific instances of breach or default are specified in this Service Contract, the City may, in the event that PMA breaches any provision of this Service Contract, exercise any legal rights it has under this Service Contract, under the security instruments and under Applicable Law to recover damages or to secure specific performance.

10.2 Events of Default by PMA.

A. Events of Default and Right to Termination. Each of the following shall constitute an Event of Default on the part of the Company for which the City, so long as the City is not in default under this Service Contract, may terminate all or certain portions of this Service Contract as provided in Section 10.2 B., unless PMA is excused from performance by the occurrence of an Uncontrollable Circumstance or City Fault (including, but not limited to, City's provision of Nonconforming City Biosolids.) Except as provided in Section 10.6, City Fault shall not include failure to pay PMA in accordance with Article 8 while PMA is in default of the Service Contract:

- (1) Security for Performance. The failure (i) of PMA to obtain or maintain in full force and effect, or renew within thirty (30) days prior to expiration, any security instrument required by Section 12.2 A. and either 12.2 B. or 12.2 C. as security for performance of this Service Contract; or (ii) of the Company's Guarantor to comply with any of its material obligations under the Guaranty Agreement;
- (2) Certain Performance Standards. The failure of the PMA (notwithstanding the payment by PMA of Nonperformance Credits or Liquidated Damages or the performance of any other related obligation to be paid or performed in connection with any such failure), except as excused by Uncontrollable Circumstances or City Fault, to meet any Performance Guarantee on a 12-month rolling average;
- (3) Failure to Comply with Applicable Law Requirements for Odors. The determination of non-compliance with Applicable Law for Odors by the appropriate regulatory agency at least once per month for a period of three (3) consecutive months.
- (4) Failure to Achieve Commencement Date. Subject to the provisions of Section 3.4 B, the failure of PMA to achieve the Commencement Date prior to or on the 180th day after the Service Contract Date.
- (5) Failure to Achieve Financial Close Date. Subject to the provisions of Section 5.6, the failure of PMA to cause the Company to achieve the Financial Close Date within fifteen (15) months of the Service Contract Date.

- (6) Failure to Achieve Construction Date. Subject to the provisions of Section 6.2 D., the failure of PMA to cause the Company to achieve the Construction Date prior to or on the third anniversary of the Service Agreement Date;
- (7) Failure to Obtain Acceptance Test Standards Achievement. Subject to the provisions of Section 6.18, the failure of PMA to cause the Company to obtain Acceptance Test Standards Achievement prior to or on the fifth anniversary of the Service Agreement Date;
- (8) Abandonment. The abandonment or failure to operate all or a substantial portion of the Operated Facilities for five (5) consecutive days in any Contract Year;
- (9) Non-Compliance with Standard City Contract Provisions. Failure to comply with the material terms set forth in Article 13, subject to the notice and cure provisions contained therein;
- (10) Failure to Make Payments. PMA fails, refuses or otherwise defaults in its duty to pay any undisputed amount required to be paid to Subcontractors or to PMA under this Service Agreement within sixty (60) days following the due date for such payment;
- (11) Insolvency. The insolvency of the of PMA, the Company or the Company's Guarantor as determined under the United States Bankruptcy Code;
- (12) Voluntary Bankruptcy. The filing by the Company or the Company's Guarantor of a petition of voluntary bankruptcy under the Bankruptcy Code; the consenting of the Company or the Company's Guarantor to the filing of any bankruptcy or reorganization petition against the Company or the Guarantor under the Bankruptcy Code; or the filing by the Company or the Guarantor of a petition to reorganize the Company or the Company's Guarantor pursuant to the Bankruptcy Code; or
- (13) Involuntary Bankruptcy. The issuance of an order of a court of competent jurisdiction appointing a receiver, liquidator, custodian or trustee of the Company or the Guarantor or of a major part of the Company's or Guarantor's property, respectively, or the filing against the Company or the Company's Guarantor of a petition to reorganize the Company or the Company's Guarantor pursuant to the Bankruptcy Code, which order shall not have been discharged or which filing shall not have been dismissed within ninety (90) days after such issuance or filing, respectively.
- (14) Failure to Perform Material Obligations. PMA's failure to perform any material obligation under this Service Contract.

B. Events of Default Not Requiring Notice or Cure Opportunity for Termination. If an Event of Default by PMA described under Section 10.2 A. (10), (11), (12), or (13) occurs, the City may terminate this Service Contract immediately upon written notice to the PMA subject to any cure rights provided herein to Company or Company's Lender.

C. Events of Default Requiring Notice or Cure Opportunity for Termination. If an Event of Default by PMA described under Section 10.2 A. and not set forth under Section 10.2 B. occurs, the City may terminate this Service Contract but only upon the notice and cure rights set forth in this Article or elsewhere in this Service Contract (including in Sections 3.4 B., 5.6, 6.2 D., 6.18 A. and Article 13) are afforded PMA. Such written notice shall state that a specified failure or refusal of PMA to perform in accordance with this Service Contract exists and which will, unless corrected within the cure period set forth in such notice (provided that such cure period is a reasonable and not shorter than may be required for PMA to effectuate the cure), constitute a breach of this Service Contract on the part of PMA and entitle the City to terminate this Service Contract for such breach. Upon expiration of such cure period without correction or without the initiation and continuation of diligent steps by PMA to correct the Event of Default, the City may terminate this Service Contract immediately upon written notice to the PMA.

D. Enforcement Costs. PMA shall pay the City all substantiated fees and costs directly incurred by or on behalf of the City in enforcing payment or performance of PMA's obligations hereunder.

E. Assignment Not Event of Default. Foreclosure of the Leasehold Mortgage or any sale thereunder whether by judicial proceeding or otherwise or any conveyance of the Class A Facilities and the interests of the Company under the Service Agreement from the Company to the Lender through or in lieu of foreclosure or other appropriate proceedings similar thereto shall not require the consent of the City nor constitute a breach of any provision of or a default under this Service Contract. Upon such foreclosure, sale or conveyance, the City shall recognize the Lender or any other sale buyer in such proceeding as the Company. In the event the Lender becomes the Company under this Service Contract and the Service Agreement, the Lender shall be liable for the obligations of the Company only for the period of time that the Lender remains the Company. Upon completion of the foreclosure, sale or conveyance, the Lender shall have the right to assign the Class A Facilities Obligations to any replacement operator recognized as competent in the biosolids industry and as being able to carry out the Company's obligations under this Service Agreement and financially capable of making any necessary improvements to the Operated Facilities and performing the obligations of the Company under the Class A Facilities Obligations, for the remaining Term. Any such replacement operator shall be subject to the approval of the City. No such assignment shall take place, and the Lender shall remain fully responsible for performing the obligations of the Company under the Class A Facilities Obligations, unless and until the replacement operator has executed and delivered to the City an agreement acknowledging and confirming its assumption of the Class A Facilities Obligations and all of the Company's obligations thereunder, together with all corporate authorizing documentation, without the consent of the City and without any restriction otherwise imposed on the Lender or the Company under the Class A Facilities Obligations. PMA shall cause any replacement Lender to execute and deliver to PMA and the City a notice and acknowledgment to the effect of the notice and acknowledgment set forth in subsection A. hereof to be delivered by the original Lender. All of the rights of the City with respect to the Class A Facilities, PMA, the Company and the Lender set forth in this Article shall be fully preserved with respect to the Class A Facilities, and any replacement operator and its Lender on any such conveyance,

assignment and assumption. Thereafter the Lender shall be released from all liability under this Service Contract without further action.

10.3 Default Notice and Lender Cure Right.

A, Default Notice. Should any Event of Default by PMA under this Service Contract occur, the City shall mail or deliver to the Lender a duplicate copy of any and all notices in writing that the City may from time to time give to or serve upon the PMA pursuant to the provisions of this Service Contract. Any such notice hereunder shall set forth the nature of the Event of Default and the actions required to cure such Event of Default. Each such notice shall be mailed or delivered to the Lender at or as near as possible to the time such notices are given to or served upon the PMA by the City if required to be so served or at the earliest opportunity if such notice is not required to be given to PMA. No notice by the City to PMA under this Section shall be deemed to be given to PMA unless and until a copy thereof shall have been mailed or delivered to the Lender.

B. Lender Cure Right. Should any Event of Default by PMA under this Service Contract occur and either (a) PMA has no cure right under this Service Contract, or (b) the PMA shall have failed to cure such Event of Default on or before the expiration of any applicable period of cure, the Lender shall have sixty (60) days after the expiration of such period of cure or receipt of written notice from the City, whichever is later, and a reasonable period of time after the expiration of such sixty (60) day period within which to remedy such default; provided that the Lender shall (1) have fully cured any default in the payment of any monetary obligations of PMA under this Service Contract within such sixty (60) day period and shall continue to pay current such monetary obligations as and when they are due, and (2) shall have commenced action to cure any non-monetary default within such sixty (60) day period (including but not limited to commencing foreclosure or other appropriate proceedings in the nature thereof designed to acquire the Company's rights in the Class A Facilities if such acquisition of the Company's rights in the Class A Facilities is necessary or appropriate to cause such cure) and (3) shall thereafter diligently prosecute such action or proceeding to completion. All rights of the City to terminate this Service Contract as a result of the occurrence of any Event of Default by PMA hereunder shall be subject to and conditioned upon the City having first given to the Lender written notice of such default as specified herein and the Lender having failed to act within the time specified in this subsection, or such longer time as extended by subsection 10.3 C. hereof.

C. Extension of Time for Cure. If the Lender is prohibited by any process or injunction issued by any Governmental Body or by reason of any action by any Governmental Body having jurisdiction or any bankruptcy reorganization, insolvency or debtor relief proceeding involving the Company or PMA or any material third-party from commencing or prosecuting foreclosure or other proceedings in the nature thereof or taking other appropriate curative action, the time specified in Section 10.5 B. above for commencing or prosecuting such foreclosure or other proceedings or taking such other appropriate curative action shall be extended for a period of such prohibition; provided that the Lender shall have fully cured any Event of Default in the payment of any monetary obligations of the Company and the Lender shall continue to pay

current such monetary obligation as and when they fall due to the extent such payments are not expressly prohibited.

D. Service Agreement to Lender. Provided that the Lender is attempting to cure in a manner consistent with this Section, if the Service Agreement is terminated by the action of any court in connection with any bankruptcy reorganization, insolvency or debtor relief proceeding involving the City, the Company or PMA or otherwise, then the City shall permit PMA to offer to the Lender or its assignee meeting the qualifications provided herein a new Service Agreement with the same tenure, terms and conditions as those in the terminated Service Agreement.

E. Service Fee Paid During Cure Period. During all periods in which PMA or the Lender are making efforts to cure an alleged Event of Default under this Service Contract, the City shall be obligated to continue paying the Service Fee as long as PMA is performing the Biosolids Services.

10.4 Termination of PMA for Default

A. Compensation After Termination. PMA shall not be entitled to any compensation for services provided subsequent to receiving a notice for termination for an Event of Default, so long as PMA is no longer providing the Biosolids Services.

B. Purchase of Class A Facilities, Materials and Equipment. Upon any termination for PMA Default under this Section, the City shall determine whether it desires to purchase any or all of the Class A Facilities, materials or equipment at the BRC Site, and if so, PMA shall cause Company to negotiate with the City a price for the Class A Facilities, materials and/or equipment on the BRC Site as they exist on the date of the Event of Default. If and to the extent that the parties cannot agree on a price within thirty (30) days from the Event of Default, the City, PMA and the Company shall appoint a qualified independent appraiser to determine the purchase price on the basis of fair market value. If the City determines not to purchase such Class A Facilities, materials or equipment as may be on the BRC Site at the date of termination, PMA shall cause the Company, within ninety (90) days of receipt of default notice, to remove such Class A Facilities and items with the right to re-use or re-sell such items.

10.5 Events of Default By City.

A. City Events of Default. So long as PMA is in compliance with the Service Contract, the following events shall be considered Events of Default by the City under this Service Contract, subject to Uncontrollable Circumstance or Company Fault, and such event shall entitle PMA to terminate this Service Contract upon expiration of the cure period (provided that such cure period is reasonable and not shorter than may be required for the City to reasonably effectuate a cure) set forth in written notice from PMA:

- (1) Representations and Warranties. Any representation or warranty of the City under Section 2.1 that was false or inaccurate in any material respect when made and the legality of this Service Contract that results in the inability of the City to carry out its obligations hereunder; or

(2) Failure to Pay. The failure, refusal or other default by the City in its duty to pay the amount required to be paid to PMA under this Service Contract within ninety (90) days following the due date for such payment; or

(3) Bankruptcy. The authorized filing by the City of a petition seeking relief under the Bankruptcy Code, as applicable to political subdivisions which are insolvent or unable to meet their obligations as they mature; provided that the appointment of a financial control or oversight board by the State for the City shall not in and of itself constitute an Event of Default hereunder; or

(4) Failure to Perform Material Obligations. The City's failure to perform any material obligation under this Service Contract.

B. Notice to the City and Cure Opportunity. If an Event of Default by the City described under Section 10.5 A. occurs, PMA may terminate this Service Contract but only upon written notice to the City and an opportunity for the City to cure such default. Written notice shall state that a specified failure or refusal of the City to perform in accordance with this Service Contract exists and which will, unless corrected within the cure period set forth in such notice (provided that such cure period is a reasonable and not shorter than may be reasonably required for the City to effectuate the cure), constitute a breach of this Service Contract on the part of City and entitle PMA to terminate this Service Contract for such breach. Upon expiration of such cure period without correction or without the initiation and continuation of diligent steps by the City to correct the Event of Default, PMA may terminate this Service Contract immediately upon written notice to the City.

C. No PMA Termination. Except for the Events of Default by the City under this Section, no City failure or refusal shall constitute an Event of Default giving the PMA the right to terminate this Service Contract.

10.6 Convenience Termination for Uncontrollable Circumstances.

A. City Ability to Terminate Due to Uncontrollable Circumstances. During the Class A Period, in the event an Uncontrollable Circumstance causes a total constructive loss of the Operated Facilities such that PMA is unable to provide the Biosolids Services the parties shall, within thirty (30) days of the Uncontrollable Circumstance, meet and discuss a course of action relative to the continuation or termination of the Service Contract, or alternatively, modification of PMA's services under the Service Contract. If City elects to exercise its right of termination under this Section, then the City shall pay the PMA an amount calculated to reimburse Company for Project Financing and Company's Additional Capital, any amounts due to PMA for the Biosolids Services to be paid as part of the Service Fee but not yet paid as of the date of termination, and reasonable demobilization costs. A "total constructive loss" for this purpose shall be deemed to have occurred: (1) if so determined by the casualty insurance carrier; or (2) if the Operated Facilities is reasonably anticipated to be inoperable for a period of at least twelve months following the occurrence of the Uncontrollable Circumstance.

B. City Ability to Terminate Due to an Extraordinary Increase in Costs. During the Class A Period, in the event an Uncontrollable Circumstance causes an extraordinary increase in City costs, the parties shall, within thirty (30) days of the Uncontrollable Circumstance, meet and discuss a course of action relative to the continuation or termination of the Service Contract, or alternatively, modification of the PMA's services under the Service Contract. "An extraordinary increase" in City costs shall be deemed to have occurred for purposes of this Section 10.6 B. if the total amount of annual Service Fee payments required to be paid by City to PMA together with the projected annual electric, gas or Alternative Fuel costs resulting from the Uncontrollable Circumstance would cause an increase of more than 20% from the prior Contract Year in the total Service Fee paid to PMA and the actual payments for electric, gas or Alternative Fuel costs. If City elects to exercise its right of termination under this Section 10.6 B. due to an extraordinary increase in City costs, in addition to City's payment to PMA of an amount calculated to reimburse Company for Project Financing and Company's Additional Capital, plus any amounts due for the Biosolids Services to be paid as part of the Service Fee but not yet paid as of the date of termination, the City shall pay the amount set forth in Section 14.1(E) of Appendix 14.

C. Modification of PMA Services. Notwithstanding the termination of the mutual obligations relative to the Class A Facilities pursuant to Sections 10.6 A. and 10.6 B., PMA may, upon mutual agreement of the parties provide Interim Period Services for a period not to exceed two (2) years after the termination of the obligations relative to the Class A Facilities, after which time this Service Contract shall terminate.

D. Payment Contingent Upon Surrender of Possession. The City shall have no obligation to pay any amounts provided for under this Section, except concurrently with the surrender of possession and control by PMA and the Company of the Operated Facilities to the City.

E. Adequacy of Payment. PMA agrees that the applicable payment amounts provided in this Section shall fully and adequately compensate PMA and all Subcontractors for all foregone potential profits, Loss-and-Expense, fees, costs and charges of any kind whatsoever (whether foreseen or unforeseen), including initial transition and mobilization costs and demobilization, employee transition and other similar wind-down costs, attributable to the termination of the PMA's right to perform this Service Contract.

10.7 PMA's Obligations upon Termination or Expiration of Term.

A. PMA Obligations. As set forth in the termination notice from the City, PMA shall, as applicable (provided that if all the Class A Facilities Obligations and any fees owed the Lender in connection therewith are not fully paid at time of the termination described herein, the legal rights of the Lender and the Lender's collateral provided herein or by operation of law are preserved):

- (1) cause Company to stop the Biosolids Services on the Termination Date;
- (2) cause Company to promptly take all action as necessary to protect and preserve all materials, equipment, tools, facilities and other property;

City-PMA Service Contract

- (3) cause Company to promptly remove from the Existing Facilities (and in the event that the City exercises its right to purchase the Class A Facilities, the Class A Facilities) all personal property owned or leased by employees of the Company or other Subcontractors;
- (4) cause Company to clean the Existing Facilities and the BRC Site (and in the event that the City exercises its right to purchase the Class A Facilities, the Class A Facilities) and leave them in a neat and orderly condition;
- (5) cause Company subject to subsection B. of this Section, to promptly remove all employees of the Company and any Subcontractors and vacate the Existing Facilities (and in the event that the City exercises its right to purchase the Class A Facilities, the Class A Facilities);
- (6) cause Company to promptly deliver to the City a list of all supplies, materials, machinery, equipment, property and special order items previously delivered or fabricated by the Company or any Subcontractor but not yet incorporated in the Operated Facilities;
- (7) cause Company to deliver to the City the Operation and Maintenance Manual and all computer programs used at the Existing Facilities (and in the event that PMA exercises its right to purchase the Class A Facilities, the Class A Facilities) in the performance of the Biosolids Services, including all revisions and updates thereto;
- (8) cause Company to deliver to the City a copy of all books and records in its possession relating to the performance of the Biosolids Services;
- (9) cause Company to provide to the City with a list of all files, and access and security codes with instructions and demonstrations which show how to open and change such codes;
- (10) cause Company to advise the City promptly of any special circumstances which might limit or prohibit cancellation of any Subcontract;
- (11) cause Company to promptly deliver to the City copies of all Subcontracts, together with a statement of:
 - (a) the items ordered and not yet delivered pursuant to each agreement;
 - (b) the expected delivery date of all such items;
 - (c) the total cost of each agreement and the terms of payment; and
 - (d) the estimated cost of canceling each agreement;

(12) cause Company to assign to the City any Subcontract that the City elects in writing, at its sole election, to have assigned to it. The City shall assume, and PMA shall be relieved of its obligations under, any Subcontract so assigned;

(13) unless the City directs otherwise, cause Company to terminate all Subcontracts and make no additional agreements with Subcontractors;

(14) cause Company as directed by the City, to transfer to the City by appropriate instruments of title, and deliver to the Operated Facilities (or such other place as the City may specify), all special order items pursuant to this Service Contract for which the City has made or is obligated to make payments;

(15) cause Company to promptly transfer to the City all warranties given by any manufacturer or Subcontractor with respect to particular components of the Design/Build Work or the Biosolids Services;

(16) cause Company to notify the City promptly in writing of any Legal Proceedings against the Company by any Subcontractor or other third party relating to the termination of the Design/Build Work or the Biosolids Services (or any Subcontracts);

(17) cause Company to give written notice of termination, effective as of the date of termination of this Service Contract, promptly under each policy of Required Insurance (with a copy of each such notice to the City), but permit the City to continue such policies thereafter at its own expense, if possible;

(18) cause Company to arrange its dealings with employees such that no "successor clause" or accrued benefit liability will bind the City in the event the City determines to offer employment to the Company's employees at the Operated Facilities following the Termination Date; and

(19) cause Company to take such other actions, and execute such other documents as may be necessary to effectuate and confirm the foregoing matters, or as may be otherwise necessary or desirable to minimize PMA's costs, and take no action which shall increase any amount payable by PMA under this Service Agreement.

B. Hiring of Company Personnel. Upon a termination due to an Event of Default by PMA or upon expiration of this Service Contract at the end of the Term, the City or any successor operator of the Operated Facilities designated by the City shall have the right to offer employment on any terms it may choose to any Company employee, including those employed at the Operated Facilities. No Company employment agreement, job offer, letter or similar document may contravene this right.

10.8 No Waivers. No action of the City or PMA pursuant to this Service Contract (including any investigation or payment) and no failure to act shall constitute a waiver by either party of the other party's obligation to comply with any term or provision of this Service Contract. No course of dealing or delay by the City or PMA in exercising any right, power or remedy under this

City-PMA Service Contract

Service Contract shall operate as a waiver thereof or otherwise prejudice such party's rights, powers and remedies. No single or partial exercise of (or failure to exercise) any right, power or remedy of City or PMA under this Service Contract shall preclude any other or further exercise thereof or the exercise of any other right, power or remedy.

10.9 No Consequential or Punitive Damages. In no event shall either party hereto be liable to the other, or obligated in any manner, to pay to the other any special, incidental, consequential, punitive or similar damages based upon claims arising out of or in connection with the performance or non-performance of its obligations or otherwise under this Service Contract, whether such claims are based upon contract, tort, negligence, warranty or other legal theory.

10.10 Non-Binding Mediation.

A. Right to Request and Decline. Either party may request Non-Binding Mediation of any dispute arising under this Service Contract, whether technical or otherwise. The non-requesting party may decline the request in its sole discretion. If there is concurrence that any particular matter shall be mediated, the provisions of this Section shall apply. The costs of such Non-Binding Mediation shall be divided equally between the City and PMA.

B. Procedure. The mediator shall be a professional engineer, attorney or other professional mutually acceptable to the parties who has no current or on-going relationship to either party. The mediator shall have full discretion as to the conduct of the mediation. Each party shall participate in the mediator's program to resolve the dispute until and unless the parties reach agreement with respect to the disputed matter or one party determines in its sole discretion that its interests are not being served by the mediation.

C. Non-Binding Effect. Mediation is intended to assist the parties in resolving disputes over the correct interpretation of this Service Contract. No Mediator shall be empowered to render a binding decision.

D. Relation to Judicial Legal Proceedings. Nothing in this Section shall operate to limit, interfere with or delay the right of either party under this Article to commence judicial Legal Proceedings upon a breach of this Service Contract by the other party, whether in lieu of, concurrently with, or at the conclusion of any Non-Binding Mediation.

10.11 Notice of Loss, Damage or Destruction of the Operated Facilities.

A. Prevention and Notification. PMA shall use care and diligence, and shall take all reasonable appropriate precautions, to protect the Operated Facilities from loss, damage or destruction. PMA shall cause the Company shall report to the City and the insurers, immediately upon obtaining knowledge thereof, any damage or destruction to the Operated Facilities and as soon as practicable thereafter shall submit a full report to the City. The PMA shall also submit to the City, within 24 hours of receipt, copies of all accident and other reports filed with, or given to the Company by, any insurance company, adjuster or Governmental Body. The parties shall cooperate so as to promptly commence and proceed with due diligence to determine the party responsible for the costs of the loss, damage or destruction, to determine the procedure for repair

of the Operated Facilities in accordance with this Service Agreement, or in the event of total destruction of the Operated Facilities, to determine whether to replace the Operated Facilities or to mutually terminate this Service Agreement, as applicable. The City shall have the right to monitor, review and inspect the performance of any repair, replacement or restoration work by the Company as if such work constituted Design/Build Work.

B. Insurance and Other Third-Party Payments. To the extent that any repair, replacement or restoration costs incurred pursuant to this Section can be recovered from any insurer or from another third-party, each party shall assist each other in exercising such rights as it may have to effect such recovery.

C. Repair of City and Private Property. PMA shall cause the Company to promptly repair or replace all property belonging to the City and all private property damaged by the Company or any officer, director, employee, representative or agent of the Company in connection with the performance of, or the failure to perform, the Biosolids Services. The repair and replacements shall restore the damaged property, to the maximum extent reasonably practicable, to its character and condition existing immediately prior to the damage.

ARTICLE 11

TERM AND SURVIVAL OF CERTAIN PROVISIONS UPON TERMINATION

11.1 Effective Date; Term. This Service Contract shall become effective on the Service Contract Date and shall continue in effect until the first to occur of (i) the twentieth anniversary of the ATSA Date or (ii) twenty-five (25) years from the Service Contract Date (the "Initial Term"), or, if renewed at the option of the City as provided in Section 11.2, until the last day of the Renewal Term (the "Renewal Term"; the Initial Term and the Renewal Term, if any, being referred to as the "Term"), unless earlier terminated in accordance with its terms, in which event the Term shall be deemed to have expired as of the date of such termination (the "Termination Date").

11.2 Option To Renew. The City shall have the option, in its sole discretion, to renew this Service Contract for an additional five (5) year term or terms aggregating five (5) years (the "Renewal Term") on the same conditions as are applicable during the Initial Term except as may be otherwise agreed by the parties. If the City renews this Service Contract pursuant to this Section, the City shall give PMA written notice of its election on or before the 90th day preceding the last day of the Initial Term. During such Renewal Term, the Service Fee payable by the City shall be in accordance with the Section 8.3.

11.3 Option to Acquire or Remove. Upon the expiration of the Initial Term or any Renewal Term, the City shall have the option, at its sole discretion, to acquire the fixed and moveable assets included as the Class A Facilities, the improvements to the Existing Facilities and any other improvements made by the Company at the BRC Site for a payment equal to the fair market value of the Company-owned Facilities, and PMA shall require the Company to remove all assets with any commercial value (for reuse by Company) and restore the BRC Site to a commercially safe and useable condition.

11.4 City Lease Extension. For each Renewal Term of the Service Contract, the term of the City Lease, shall be automatically extended so that each agreement ends not earlier than one month following the end of the Renewal Term.

11.5 Survival Of Certain Provisions Upon Termination. The rights and obligations of the parties pursuant to Article 2 [Representations/Warranties], Article 8 [Service Fee], , Section 12.4 [Property Rights], Section 12.5 [Proprietary Information/IP], Section 12.16 [Notices] Section 13.13 [Indemnification]and all other provisions of this Service Contract that so provide shall survive the termination of this Service Contract Termination of this Service Contract shall not (i) limit or otherwise affect the respective rights and obligations of the parties accrued prior to the date of such termination or expiration, or (ii) preclude either party from impleading the other party in any Legal Proceeding originated by a third party as to any matter occurring during the Term.

ARTICLE 12

GENERAL PROVISIONS

12.1 Uncontrollable Circumstances.

A. Relief from Obligations. Except as expressly provided under this Service Contract, PMA shall not be liable for any loss, damage, delay, default or failure to perform any obligation to the extent it results from an Uncontrollable Circumstance. The occurrence of an Uncontrollable Circumstance shall not excuse or delay the performance of a party's obligation to pay monies previously accrued and owing under this Service Contract, or to perform any obligation hereunder not affected by the occurrence of the Uncontrollable Circumstances.

(1) The City shall pay the Service Fee during the occurrence or continuance of any Uncontrollable Circumstance, adjusted to account for any insurance payments and cost reductions achieved through PMA mitigation measures required by subsection B. of this Section, as well as for any cost increases to which the PMA is entitled under subsection C. of this Section.

(2) If the Uncontrollable Circumstance is related to the construction of the Class A Facilities the Fixed Capacity Charge portion of the Service Fee shall be adjusted pursuant to Section 8.4 B.(1) provided that the adjustment shall include any insurance payments and cost reductions achieved through PMA mitigation measures required by Section 12.1 B.

B. Notice and Mitigation. The party that asserts the occurrence of an Uncontrollable Circumstance shall notify the other party by telephone or facsimile, on or promptly after the date the party experiencing such Uncontrollable Circumstance first knew of the occurrence thereof, followed within fifteen (15) days by a written description of: (1) the Uncontrollable Circumstance and the cause thereof; and (2) the date the Uncontrollable Circumstance began, its estimated duration, the estimated time during which the performance of such party's obligations hereunder shall be delayed, or otherwise affected. As soon as practicable after the occurrence of an Uncontrollable Circumstance, the affected party shall also provide the other party with a description of: (a) the amount, if any, by which the Service Fee is proposed to be adjusted as a result of such Uncontrollable Circumstance; (b) any areas where costs might be reduced and the approximate amount of such cost reductions; and (c) its estimated impact on the other obligations of such party under this Service Contract. The affected party shall also provide prompt written notice of the cessation of such Uncontrollable Circumstance. Whenever such act, event or condition shall occur, the party claiming to be adversely affected thereby shall, as promptly as practicable, use all reasonable efforts to eliminate the cause, reduce costs and resume performance under this Service Contract. While the Uncontrollable Circumstance continues, the affected party shall give notice to the other party, before the first day of each succeeding month, updating the information previously submitted. The party claiming to be adversely affected by an Uncontrollable Circumstance shall bear the burden of proof, and shall furnish promptly any

additional documents or other information relating to the Uncontrollable Circumstance reasonably requested by the other party.

C. Conditions to Performance, Service Fee and Schedule Relief. If and to the extent that Uncontrollable Circumstances interfere with, delay or increase the cost of PMA's performing the Biosolids Services in accordance herewith, PMA shall be entitled to an increase in the Service Fee and/or an extension of schedule which properly reflects the interference with performance, the amount of the increased cost, or the time lost as a result thereof, in each case only to the minimum extent reasonably forced on the Company by the event, and PMA shall perform all other Biosolids Services. The proceeds of any Required Insurance available to meet any such increased cost, and the payment by the Company of any deductible, shall be applied to such purpose prior to any determination of cost increase payable by the City under this Section. Any cost reduction achieved through the mitigating measures undertaken by PMA pursuant to subsection 12.1 B. upon the occurrence of an Uncontrollable Circumstance shall be reflected in a reduction of the amount by which the Service Fee would have otherwise been increased or shall serve to reduce the Service Fee to reflect such mitigation measures, as applicable. In the event that the PMA believes it is entitled to any Service Fee or schedule relief on account of any Uncontrollable Circumstance, it shall cause the Company to furnish the City written notice of the specific relief requested and detailing the event giving rise to the claim within thirty (30) days after the giving of notice delivered pursuant to subsection B. of this Section, or if the specific relief cannot reasonably be ascertained and such event detailed, within such thirty-day period, then within such longer period with which it is reasonably possible to detail the event and ascertain such relief. Within thirty (30) days after receipt of such a timely submission from the Company, the City shall issue a written determination as to the extent, if any, it concurs with the PMA's claim for performance, price or schedule relief, and the reasons therefor.

12.2 Security for Performance.

A. Guaranty Agreement. The Company's Guaranty Agreement has been provided on or prior to the Service Contract Date and shall be maintained throughout the Term in the form attached hereto as a Transaction Agreement.

(1) Reporting Requirements. PMA shall cause the Company and Company's Guarantor to deliver to the City, within one hundred twenty (120) days after the end of each fiscal year of Company's Guarantor, a copy of the annual audited financial statement of Company's Guarantor, which statement shall be prepared in accordance with generally accepted accounting principles consistently applied and certified by a nationally recognized independent public accountant selected by Company's Guarantor.

(2) Material Adverse Change. If a material adverse change occurs in the financial condition of the Company's Guarantor, PMA shall cause the Company to promptly notify the City.

B. Performance and Payment Bonds.

(1) Service Agreement Performance Bond. PMA shall cause the Company to provide to the City a Service Contract Performance Bond in form set forth in the Transaction Agreement Forms and in the amount equal to 100% of the annual Interim Service Fee or Class A Service Fee less the FCC, as applicable (the "Service Contract Performance Bond") as reasonably estimated in the most recent estimate filed by the Company and approved by the City. The Service Contract Performance Bond shall secure the faithful performance of the Biosolids Services and the payment of labor, outside services, and supplies required for the PMA's obligations under this Service Contract, including the Biosolids Services but excluding the Construction Work and excluding any obligation of the PMA to cause the Company to provide Project Financing and all costs and Liquidated Damages associated with such failure. Notwithstanding the foregoing, PMA shall require the Company (and the Company's Guarantor) shall remain responsible to pay any Liquidated Damages associated with the failure to provide Project Financing. The Service Contract Performance Bond may be provided on an annual basis and the liability to the surety for each period shall not be cumulative. The first such bond shall be provided to the City on or before the Commencement Date. Each subsequent bond or other adequate security shall be provided to the City not later than thirty (30) days prior to the expiration of the current bond.

(2) Construction Performance Bond and Labor and Materials Payment Bond. PMA shall cause the Company to provide, in accordance with the forms set forth in the Transaction Agreement Forms, as financial security for the performance of its construction obligations and prompt payment of moneys that are due to all persons furnishing construction labor and materials at the BRC Site, a Construction Performance Bond and a Labor and Materials Payment Bond. PMA shall cause the Company to have the Construction Performance Bond and Labor and Materials Payment Bonds issued in the name of PMA (as one of the obligees), in the amount of the Fixed Design-Build Price less financing transaction costs.

(3) Cost of Obtaining Security for Performance. The cost and expense of obtaining and maintaining the security instruments required under this Article as security for the performance of PMA's obligations hereunder shall be borne by the PMA without reimbursement from the City except indirectly by way of the Service Fee.

(4) Form of Bonds and Surety Company Requirements. The Service Contract Performance Bond, the Construction Performance Bond and the Labor and Materials Payment Bond shall (a) be in the form approved by the City and (b) issued by a surety listed on the then-current annual "Surety List" promulgated by the Commonwealth Insurance Department. The Service Contract Performance Bond amount must be in an amount permitted by the Surety List. If the surety issuing the Service Contract Performance Bond fails to meet the requirements of this Section, PMA shall cause the Company to obtain a Service Agreement Performance Bond issued by a surety that meets the requirements of the Surety List within thirty five (35) days from the date the inadequate Service Contract Performance Bond was rejected by the City.

C. Letter of Credit. In lieu of the required Service Contract Performance Bond, PMA may permit Company to provide a Letter of Credit in accordance with the provisions in this Section.

(1) The Letter of Credit shall comply with all applicable requirements of this Service Contract.

(2) The Letter of Credit shall be available to draw against up to and including the maximum amount thereof for any and all claims that may arise for ninety (90) days after the expiration of the then-current Letter of Credit, if no acceptable renewal Letter of Credit or performance bond is timely provided.

(3) The Letter of Credit shall be issued by a bank that has a long-term credit rating of at least AA by Standard and Poors, Inc. and Aa by Moody's Investors Service, Inc. ("Acceptable Credit Rating") and shall be approved by the City, which approval shall not be unreasonably withheld. If the bank issuing the Letter of Credit is incorporated/chartered outside the United States of America and does not have a domestic branch, the Letter of Credit must be confirmed by a domestic bank with an Acceptable Credit Rating. If the credit rating of the bank issuing the Letter of Credit or the confirming bank drops below an Acceptable Credit Rating, the Company must supply a substitute Letter of Credit with an Acceptable Credit Rating within thirty-five (35) days of notice to or knowledge of the Company of such event.

(4) The Company shall furnish or shall cause to be furnished a legal opinion acceptable to the City from independent counsel or the bank's counsel stating that the Letter of Credit is legally enforceable in the United States as to the issuing bank, and, if applicable, the confirming bank.

(5) The duly authorized representative of the City for the Letter of Credit is the Executive Director.

(6) The Letter of Credit shall be in a form acceptable to the City. The issuing bank must furnish an acceptable form of draw certificate and sight draft with the Letter of Credit.

(7) The Letter of Credit shall provide for annual renewal, after successful completion of the first twelve (12) months of operation following the Commencement Date. During each subsequent twelve (12) month period, the stated amount of the Letter of Credit amount shall be adjusted to an amount equal to the anticipated value of the Service Fee for that period.

(8) Any Letter of Credit issued during the Term shall contain a clause providing for the automatic annual renewal of the Letter of Credit on the beginning day of the City's fiscal year (July 1).

(9) In the event the Letter of Credit is not automatically renewed as contemplated in this Section, a substitute Letter of Credit or performance bond shall be delivered to the

City for each annual renewal period at least sixty (60) days before the expiration of the Letter of Credit. The failure by the Company to provide such surety by such date shall constitute an Event of Default as provided in Article 10.

D. Monitoring of Sureties. PMA shall cause the Company to be responsible throughout the Term for monitoring the financial condition of any surety company issuing bonds under this Service Contract and for making inquiries no less often than annually to confirm that each such surety company maintains at least the minimum rating level specified in this Section. In the event the rating of any issuing surety company falls below such minimum level, the Company shall promptly notify PMA and PMA shall notify the City of such event and shall promptly furnish or arrange for the furnishing of a substitute or an additional bond of a surety company whose rating and other qualifications satisfy all above requirements.

12.3 Relationship of the Parties. PMA and its Subcontractors are independent of the City and the relationship between the the City and PMA shall be limited to performance of this Service Contract in accordance with its terms. Unless otherwise specifically stated herein, neither party shall have any responsibility with respect to the services to be provided or contractual benefits assumed by the other party. Nothing in this Service Contract shall be deemed to constitute either party a partner, agent or legal representative of the other party. No liability or benefits, such as workers compensation, pension rights or liabilities, or other provisions or liabilities arising out of or related to a contract for hire or employer/employee relationship, shall arise or accrue to any party's agent or employee as a result of this Service Contract or the performance thereof.

12.4 Property Rights.

A. Protection from Infringement. PMA shall cause the Company to pay all royalties and license fees in connection with the Biosolids Services, including the Design/Build Work. PMA shall, and shall cause the Company, to protect, indemnify, defend and hold harmless the City in the manner provided in Section 13.13, from and against all Loss-and-Expense arising out of or related to the infringement or unauthorized use of any patent, trademark, copyright or trade secret relating to, the Biosolids Services (including the Design/Build Work), or at its option, shall acquire the rights of use under infringed patents, or modify or replace infringing equipment with equipment equivalent in quality, performance, useful life and technical characteristics and development so that such equipment does not so infringe. The provisions of this Section shall survive termination of this Service Contract.

B. Intellectual Property Developed by the Company. The City agrees that all intellectual property developed by the Company at or directly due to the use of the Operated Facilities or otherwise in connection with the performance of the Biosolids Services shall be owned by the Company subject to the terms and conditions of this Section, and is hereby licensed to the City via PMA on a non-exclusive cost free, perpetual basis for use by the City and any successor operator of the Operated Facilities (but, with respect to any successor operator, only in connection with the operation of the Operated Facilities). Such intellectual property shall include technology, inventions, innovations, processes, know-how, formulas and software, whether protected as proprietary information, trade secrets, or patents. The City shall not license, transfer

or otherwise make available such intellectual property to any third-party for remuneration except with the consent of the Company.

C. Company's Right to Protection of Proprietary Information. If PMA requires Company to provide City or the public with reports, data, information or documentation of any kind, the Company may provide such information either with proprietary information belonging to the Company redacted, withheld or clearly marked as confidential and proprietary. "Confidential and Proprietary" information shall be marked by the Company, on each page where confidential and proprietary information appears. City shall, to the extent it may obtain clearly identified proprietary information belonging to the Company, make reasonable efforts not disclose such proprietary information to the public. Should City receive a request from the public to which City must reply under Applicable Law, City shall notify Company of the request and, if City is required to respond in a short time period, City shall immediately request an extension of time to respond to the requesting party. Upon notification, if the Company determines that the request to City would require City to disclose proprietary information which the Company seeks to protect from public disclosure, the Company shall immediately take the proper steps to become involved as a party to the request and shall assert its objections and/or defend City, at Company's cost, in responding to the open records or public disclosure request.

12.5 Cost Substantiation. All costs proposed or incurred by PMA which are directly or indirectly chargeable to the City in whole or in part shall be the fair market price for the good or service provided, or, if there is no market, (including costs related to emergency actions and other additional work necessitated or additional costs to be borne on account of Uncontrollable Circumstances, City Fault or at City direction) shall be a commercially reasonable price. PMA shall cause the Company to provide certified Cost Substantiation for all such other costs invoiced to the City. To the extent reasonably necessary to confirm direct costs required to be Cost Substantiated, copies of timesheets, invoices, canceled checks, expense reports, receipts and other documents, as appropriate, shall be delivered to the City with the request for reimbursement of such costs.

12.6 Subcontractors.

A. Use Restricted. PMA shall cause the Company to operate the Operated Facilities with its own employees and in accordance with Article 5 and Article 7. Other Subcontractors may be used to perform Biosolids Services, subject to the City's right of approval set forth in Subsection 12.6 and the approvals required by the City's Minority Business Council, as set forth in Section 13.4 and Appendix 13.

B. City Review and Approval of Permitted Subcontractors. the City shall have the right to approve all Subcontractors which PMA and the Company are permitted to engage under Subsection 12.6 A. for Biosolids Services, such approval not to be unreasonably withheld, except that no approval shall be necessary for use of approved Subcontractors listed on Appendices 13 and 15 and Subcontractors hired by the Company for purposes of remedying an emergency situation. PMA shall cause the Company to furnish the City written notice of its intention to engage such Subcontractor, along with its proper entity name and address. In no

City-PMA Service Contract

event shall any Subcontract be awarded to any person debarred, suspended or disqualified from State, City or PMA contracting.

C. Subcontract Terms and Subcontractor Actions. PMA shall retain full responsibility to the City under this Service Contract for all matters related to the Biosolids Services notwithstanding the execution or terms and conditions of any Subcontract. No failure of any Subcontractor used by PMA in connection with the provision of the Biosolids Services shall relieve PMA from its obligations to perform the Biosolids Services, unless such failure, if experienced directly by the PMA, would be excused under the terms of this Service Contract such as in the case of an Uncontrollable Circumstance or City Fault. PMA shall be responsible for settling and resolving with all Subcontractors all claims arising out of delay, disruption, interference, hindrance, or schedule extension.

D. Subcontractor Claims. PMA shall pay or cause to be paid to all Subcontractors all amounts due in accordance with their respective Subcontracts. No Subcontractor shall have any right against the City for labor, services, materials or equipment furnished for the Biosolids Services.

E. Assignability. All Subcontracts entered into by PMA or its Subcontractors with respect to the Operated Facilities shall be assignable to PMA, and PMA shall assign the same to the City, solely at the City's election and without cost or penalty, upon the expiration or termination of this Service Contract.

12.7 Rights of the City in its Governmental Capacity Not Limited. Nothing in this Service Contract shall be interpreted as limiting the rights and obligations of the City under Applicable Law in its governmental or regulatory capacity.

12.8 No City Obligation to Issue Governmental Approvals. The City retains all issuance and approval rights it has under Applicable Law with respect to any Governmental Approval required with respect to the Biosolids Services and other obligations of PMA under this Service Contract, and none of such rights shall be deemed to be waived, modified or amended as a consequence of the execution of this Service Contract. Notwithstanding the foregoing, failure by the City to issue Governmental Approvals when PMA or the Company has complied with all Applicable Law relative to the securing of such Governmental Approvals shall be considered an Uncontrollable Circumstance as to PMA and the Company.

12.9 Assignment by PMA. PMA shall not assign, transfer, convey, sell, lease, encumber or otherwise dispose of this Service Contract, its right to execute the same, or its right, title or interest in all or any part of this Service Contract or any monies due hereunder whatsoever prior to their payment to PMA, without the prior written consent of City. Any such approval given in one instance shall not relieve the PMA of its obligation to obtain the prior written approval of the City to any further assignment. Any such assignment of this Service Contract which is approved by the City shall require the assignee of PMA to assume the performance of and observe all obligations, representations and warranties of PMA under this Service Contract, and no such assignment shall relieve the Company's Guarantor of any of its obligations under the Guaranty Agreement, which shall remain in full force and effect during the Term, unless a new Company's

City-PMA Service Contract

Guarantor is proposed by an approved assignee of the Service Contract, and the City consents. The approval of any assignment, transfer or conveyance shall not operate to release PMA in any way from any of its obligations under this Service Contract unless such approval specifically provides otherwise. Notwithstanding the provisions of this Section, PMA may permit the Company to assign and grant a security interest in the Service Agreement to the Lender or to a Company Financing Entity for the purpose of securing the Class A Financing Obligations.

12.10 Assignment by the City. The City may, assign its rights and obligations under this Service Contract, without the consent of PMA, to another Governmental Body if such assignee assumes, and is legally and financially capable of discharging, the duties and obligations of the City hereunder.

12.11 Binding Effect. This Service Contract shall inure to the benefit of and shall be binding upon the City and PMA and any assignee acquiring an interest hereunder consistent with this Article.

12.12 Amendment and Waiver. This Service Contract may not be amended except by a written agreement signed by the parties. Any of the terms, covenants, and conditions of this Service Contract may be waived at any time by the party entitled to the benefit of such term, covenant or condition if such waiver is in writing and executed by the party against whom such waiver is asserted.

12.13 Non-Discrimination. The PMA, Company, its Subcontractors and its suppliers in performing under this Service Contract shall comply with the requirements of Article 13.

12.14 Notices.

A. Procedure. Any notices or communications required or permitted hereunder shall be in writing and shall be sufficiently given if transmitted by hardcopy telecommunication or delivered in person, or by overnight courier to the following:

If to the PMA:

Philadelphia Municipal Authority
1515 Arch Street, 9th Floor
Philadelphia, PA 19102

Attention: Executive Director

With Copy to:

Philadelphia Biosolids Services, LLC
7014 E. Baltimore Street
Baltimore, MD, 21224

If to the City of Philadelphia:

City-PMA Service Contract

Philadelphia Water Department
1101 Market Street, 5th Floor
Philadelphia, PA 19107

Attention: Water Commissioner

B. Notice Address Change. Changes in the respective addresses to which such notices may be directed may be made from time to time by any party by written notice to the other party. Notices and communications given by mail hereunder shall be deemed to have been given five (5) days after the date of dispatch; all other notices shall be deemed to have been given upon receipt.

12.15 Notice of Litigation. In the event the City or PMA receives notice of or undertakes the defense or the prosecution of any Legal Proceedings, claims, or investigations in connection with the Operated Facilities or the Biosolids Services, the party receiving such notice or undertaking such prosecution shall give the other party timely notice of such proceedings and shall inform the other party in advance of all hearings regarding such proceedings in accordance with Section 12.14.

12.16 Further Assurances. PMA and the City each agree to execute and deliver such further instruments and to perform any acts that may be necessary or reasonably requested in order to give full effect to this Service Contract. PMA and the City, in order to carry out this Service Contract, each shall use all commercially reasonable efforts to provide such information, execute such further instruments and documents and take such actions as may be reasonably requested by the other and not inconsistent with the provisions of this Service Contract and not involving the assumption of obligations or liabilities different from or in excess of or in addition to those expressly provided for herein.

ARTICLE 13

STANDARD CITY CONTRACT PROVISIONS

13.1 General. This Section contains standard City contract provisions required by the City of PMA and the Company as its contractor.

13.2 Requisite Licensure and Qualifications. PMA and all of the persons acting on PMA's behalf, including, without limitation, the Company, Subcontractors, in connection with the services and materials under this Service Contract, possess and, at all times during the Term, shall possess all licenses, certifications, qualifications or other credentials required in accordance with Applicable Law and the terms of this Service Contract and Lease, to perform the Services and provide the Materials. PMA shall cause the Company to provide the City with copies of all licenses, credentials and certifications required within ten (10) days of request by the City.

If Company is a "business" as defined in The Philadelphia Code, Section 19-2601, PMA shall cause the Company to maintain during the Term, a valid, current Business Privilege License, issued by the City's Department of Licenses and Inspections, to do business in the City. Each Subcontractor, if any, shall hold a valid, current Business Privilege License to do business in the City, if required by Applicable Law.

13.3 Prevailing Wage Requirements. PMA shall cause the Company and other Subcontractors to pay Prevailing Wages as defined in the Philadelphia Code Section 17-107 (k) for all building or construction work performed at the BRC Site.

A. Such Philadelphia Code definition of Prevailing Wages includes the following occupational classifications and wage rate determinations:

(1) With respect to any occupational classification for which the Secretary of Labor of the United States has calculated a prevailing wage pursuant to the Davis-Bacon Act, 40 U.S.C. § 276(a), et seq., as follows: The aggregate of (1) the hourly wage for the respective occupational classifications within a given craft, trade or industry for the Philadelphia area, determined by the Secretary of Labor of the United States in accordance with the provisions of the Davis-Bacon Act; provided, however, that during the period of any substantial work stoppage involving rates of wages in a given craft, trade or industry, such wages for such craft, trade or industry shall be those as last so determined by the Secretary of Labor prior to such work stoppage and (2) the additional benefits, for which a monetary equivalent may be determined, and which are given employees pursuant to a bona fide collective bargaining agreement for such craft, trade or industry in the Philadelphia area, or the monetary equivalent of such benefits.

(2) With respect to all other occupational classifications, as follows: The aggregate of (a) the wage paid to the majority (more than fifty (50) percent) of the workers in the classification on similar projects in the Philadelphia area, or, if the same wage is not paid

to a majority of those employed in the classification, the average of the wages paid weighted by the total employed in the classification; provided that the Director is authorized to determine a reasonable approximation of the foregoing, and in doing so may, but need not, rely on the wages determined by the Secretary of Labor under the Service Agreement Act, 41 U.S.C. § 351 or other related acts; and (b) the additional benefits, for which a monetary equivalent may be determined, and which are given employees pursuant to a bona fide collective bargaining agreement for such service in the Philadelphia area, or the monetary equivalent of such benefits.

13.4 Participation of Minority, Woman and Disabled Business Enterprises Under Executive Order 2-05.

A. In accordance with Executive Order 2-05 attached hereto in Appendix 13, as it may be amended from time to time, the City has established an anti-discrimination policy that relates to the solicitation and inclusion of Minority Business Enterprises ("MBE"), Woman Business Enterprises ("WBE"), and Disabled Business Enterprises ("DSBE") (collectively, "M/W/DSBE") in City contracts. The purpose of Executive Order 2-05 is to ensure that all businesses desiring to do business with the City have an equal opportunity to compete by creating access to the City's procurement process and meaningfully increasing opportunities for the participation by M/W/DSBEs in City contracts at all tiers of contracting, as prime contractors, subcontractors and joint venture partners. In furtherance of this policy, the City has established participation ranges for this Agreement.

B. PMA has committed itself, the Company and Subcontractors to providing significant portions of the Biosolids Services to individual MBEs, WBEs and/or DSBEs such that their work under this Service Contract will make a material difference in the individual MBEs', WBEs' and/or DSBEs' capacity to engage in future contracts with the City or private parties.

C. PMA covenants and represents to the City that the Company is a joint venture of three firms including a MBE and a WBE, and that the MBE and WBE firms have equity ownership in the Company as specified in Appendix 13.

D. In furtherance of the participation commitments identified above, PMA agrees and shall cause the Company and Subcontractors to comply with and be subject to Executive Order 02-05 and the following special provisions to this Service Contract:

(1) PMA shall cause the Company to provide Solicitation and Commitment Forms to the City's Minority Business Enterprise Council ("MBEC") identifying the MBEs, WBEs and/or DSBEs in accordance with the Service Contract and Appendix 12. Prior to the commencement of any Biosolids Services including Interim Period operations, Design Work, Construction Work and Class A Period operations, Company shall secure the prior written approval of the MBEC of the MBEs, WBEs and/or DSBEs to be utilized for the respective work. PMA shall cause the Company to have obtained MBEC approval prior to making any changes or modifications to the MBEC-approved Service Contract commitments made by Company herein, including, without limitation, substitutions for its MBEs, WBEs and/or DSBEs, changes or reductions in work

provided by its M/W/DSBE Subcontractors, or changes or reductions in the dollar and/or percentage amounts of commitments with its M/W/DSBE Subcontractors.

(2) PMA shall cause the Company, within thirty (30) business days after receipt of a payment from PMA for work performed under the Service Contract, to deliver to its M/W/DSBE Subcontractors the proportionate share of such payment for Work performed by its M/W/DSBE Subcontractors. In connection with payment of its M/W/DSBE Subcontractors, PMA shall cause the Company to comply fully with the City's and PMA's payment reporting process which may include the use of electronic payment verification systems.

(3) PMA shall cause the Company, in the event of an increase in units of Work and/or compensation under the Service Contract, to increase its commitments with its M/W/DSBE Subcontractors proportionately. The MBEC may from time to time request documentation from PMA evidencing compliance with this provision.

(4) PMA shall cause the Company to submit, within the time frames prescribed by the City, any and all documentation the City may request, including, but not limited to, copies of Subcontract(s) with M/W/DSBEs, participation summary reports, M/W/DSBE Subcontractor invoices, telephone logs and correspondence with M/W/DSBE Subcontractors, cancelled checks and certification of payments. PMA shall cause the Company to maintain all documentation related to Executive Order 02-05 for a period of five (5) years from the date of Company's receipt of final payment under the Service Agreement.

(5) PMA shall cause the Company to permit the City, in its sole discretion, conduct periodic reviews to monitor Company's compliance with the terms of Executive Order 02-05.

(6) PMA shall cause the Company to agree that in the event the City's Director of Finance determines that Company has failed to comply with any of the requirements of Executive Order 02-05, so long as Company has been given written notice and a reasonable opportunity to cure, the City may, in addition to any other rights and remedies it may have under the Service Contract, exercise one or more of the following remedies which shall be deemed cumulative and concurrent:

(a) Debar Company from proposing on and/or participating in any future contracts for a maximum period of three years.

(b) Recover as Liquidated Damages, one percent (1%) of the total dollar amount of the annual Service Fee in any applicable Contract Year, which amount shall include any increase by way of amendments to the Service Contract, for each one percent (1%) (or fraction thereof) of the shortfall in commitment(s) to Company's M/W/DSBE Subcontractors.

City-PMA Service Contract

(c) Upon a failure by Company to meet M/W/DSBE Subcontractor participation commitments in this Service Contract for twenty four (24) consecutive months, the City may declare an Event of Default, with the right to terminate under the Service Contract.

Notwithstanding the foregoing, the City shall not exercise any of the rights and remedies it may have under the Service Agreement or this Section during the pendency of any appeal by PMA of a determination by the City's Director of Finance under this Section.

E. There is no privity of contract between the City and any M/W/DSBE Subcontractor identified herein and the City does not intend to give or confer upon any such M/W/DSBE Subcontractor(s) any legal rights or remedies in connection with the subcontracted Work under Executive Order 02-05 or by reason of this Service Contract except such rights or remedies that the M/W/DSBE Subcontractor may seek as a private cause of action under any legally binding contract to which it may be a party. The remedies enumerated above are for the sole benefit of the City and the City's failure to enforce any provision or the City's indulgence of any non-compliance with any provision hereunder, shall not operate as a waiver of any of the City's rights in connection with this Service Contract nor shall it give rise to actions by any third parties including identified M/W/DSBE Subcontractors.

It is understood that false certification or representation is subject to prosecution under Title 18 Pa. C.S. §§ 4107.2 and 4904.

13.5 Federal Laws. PMA shall, and shall cause the Company to comply with the provisions of Title VI of the Civil Rights Act of 1964 (42 U.S.C. §§ 2000d – 2000d.7), Section 504 of the Federal Rehabilitation Act of 1973 (29 U.S.C. § 794), the Age Discrimination Act of 1975 (42 U.S.C. §§ 6101 – 6107), Title IX of the Education Amendments of 1972 (20 U.S.C. § 1681), and 45 C.F.R. Part 92, as they may be amended from time to time, which together prohibit discrimination on the basis of race, color, national origin, sex, handicap, age and religion.

13.6 No Indebtedness to the City.

A. PMA, the Company and any and all entities controlling Company, under common control with Company or controlled by Company are not currently indebted to the City, and will not at any time during the Term of this Service Agreement be indebted to the City, for or on account of any delinquent taxes (including, but not limited to, taxes collected by the City on behalf of the School District of Philadelphia), water bills, sewer bills, liens, judgments, fees or other debts for which no written agreement or payment plan satisfactory to the City has been established. PMA shall cause the Company to remain current during the Term of this Service Contract under all such agreements and payment plans, and shall inform the City in writing of Company's receipt of any notices of delinquent payments under any such agreement or payment plan within five (5) days after receipt. In addition to any other rights or remedies available to the City at law or in equity, PMA acknowledges that any breach or failure to conform to this representation, warranty and covenant may, at the option of City, result in the withholding of payments otherwise due to PMA under this Service Contract or any other agreement with the City under which the City may

then owe payment of any kind, and, if such breach or failure is not resolved to the City's satisfaction within a reasonable time frame specified by the City in writing, may result in the offset of any such indebtedness against said payments. In addition, PMA understands that false certification, representation or warranty by it, is subject to prosecution under Title 18 Pa. C.S.A. § 4904.

B. PMA shall require the Company and all Subcontractors performing work in connection with this Service Contract, with appropriate modifications to the language regarding the parties, to be bound in writing by the following provision and PMA shall reasonably cooperate the City in exercising the rights and remedies described below or otherwise available at law or in equity:

"Subcontractor hereby certifies and represents that Subcontractor and Subcontractor's parent company(ies) and subsidiary(ies) are not currently indebted to the City and will not at any time during the term of PMA's Service Contract with City, including any extensions or renewals thereof, be indebted to the City, for or on account of any delinquent taxes (including, but not limited to, taxes collected by the City on behalf of the School District of Philadelphia), liens, judgments, fees or other debts for which no written agreement or payment plan satisfactory to the City has been established. In addition to any other rights or remedies available to the City at law or in equity, Subcontractor acknowledges that any breach or failure to conform to this certification may, at the option and direction of the City, result in the withholding of payments otherwise due to Subcontractor for services rendered in connection with the Service Contract and, if such breach or failure is not resolved to the City's satisfaction within a reasonable time frame specified by the City in writing, may result in the offset of any such indebtedness against said payments otherwise due to Subcontractor and/or the termination of Subcontractor for default (in which case Subcontractor will be liable for all excess costs and other damages resulting from the termination)."

To the best of PMA's knowledge, information and belief, the representations made in any Subcontract that Subcontractor is not indebted to the City are true and correct. 13.7 Non-Suspension; Debarment. PMA, Company and all of the individuals acting on Company's behalf including, without limitation, Subcontractors, are not under suspension or debarment from doing business with the Commonwealth of Pennsylvania, any other state, or the federal government, or any department, agency or political subdivision of any of the foregoing. If PMA cannot so warrant, then PMA shall submit to the Responsible Official a full, complete written explanation as to why PMA cannot so warrant. For purposes of this Service Contract, the "Responsible Official" shall mean the City of Philadelphia Procurement Commissioner. PMA shall reimburse the City for the reasonable cost of investigation incurred by the City or the Commonwealth of Pennsylvania Office of Inspector General for investigation of Company's compliance with the terms of this Service Contract or any other contract between Company and the City which results in the suspension or debarment of Company. Such costs shall include, but are not limited to, salaries of investigators, including overtime, travel and lodging expenses, expert witness and documentary fees and attorney fees and expenses. PMA shall not be responsible for costs of investigations which do not result in Company's suspension or debarment.

13.8 City Audit. From time to time during the Term of this Service Contract, and for a period of five (5) years after the expiration or termination of this Service Contract, the City may audit

any and all aspects of PMA's performance under this Service Contract, including but not limited to its billings and invoices. Audits may be conducted by representatives, agents or contractors of the City, or other authorized by the City representatives including, without limitation, the City Controller. If requested by the City, PMA shall submit and shall cause the Company to submit all vouchers or invoices presented for payment pursuant to this Service Contract, all cancelled checks, work papers, books, records and accounts upon which the vouchers or invoices are based, and any and all documentation and justification in support of expenditures or fees incurred pursuant to this Service Contract. All books, invoices, vouchers, records, reports, cancelled checks and other materials related to PMA's obligations under the Service Contract shall be subject to periodic review or audit by the City.

13.9 Availability of Records. PMA shall and shall cause Company to make available, in the City at reasonable times during the Term of this Service Contract and for the period set forth in Retention of Records below, all records pertaining to this Service Contract for the purpose of inspection, audit or reproduction by any authorized representative (including any agent or contractor and the City Controller) of the City, the Commonwealth of Pennsylvania Auditor General, and any other federal and state auditors, as may be applicable.

13.10 Retention of Records. PMA shall and shall cause Company to retain all records, books of account and documentation pertaining to this Service Contract for a period of five (5) years following expiration or termination of the Service Contract, Service Agreement, City Lease or Lease; however, if any litigation, claim or audit is commenced prior to expiration of said five (5) year period, then the records shall be retained until all litigation, claims or audit findings have been completely terminated or resolved, without right of further appeal, or if Applicable Law requires a longer period, then the records shall be retained for such longer period.

13.11 Independent Contractor. PMA is an independent contractor and shall not in any way or for any purpose be deemed or intended to be an employee or agent of the City. Neither PMA nor its agents, employees or Subcontractors shall in any way represent that they are acting as employees, officials or agents of the City

13.12 No Joint Venture. The Parties do not intend to create, and nothing contained in this Service Contract shall be construed as creating, a joint venture arrangement or partnership between PMA and the City.

13.13 Indemnification

A. PMA's Indemnification. PMA shall indemnify, defend and hold harmless the City (including all officers, board members and commissioners, and employees) from and against any and all losses, costs (including, but not limited to, litigation and settlement costs and counsel fees and expenses), claims, suits, actions, damages, liability and expenses, occasioned wholly or in part by Company's failure to perform any of its obligations under the Service Agreement or Company's negligence, omission or fault, or the negligence, omission or fault of PMA's agents, Subcontractors, independent contractors, suppliers, employees or servants in connection with this Service Contract, including, but not limited to, those in connection with loss of life, bodily injury, personal injury, damage to property, contamination or adverse effects on the environment,

intentional acts, failure to pay any Subcontractors and suppliers, any breach of the Service Contract, and any infringement or violation of any proprietary right (including, but not limited to, patent, copyright, trademark, service mark and trade secret).

B. Company Indemnification of City. PMA shall cause Company to indemnify, defend and hold harmless the City (including all officers, board members and commissioners, and employees) from and against any and all losses, costs (including, but not limited to, litigation and settlement costs and counsel fees and expenses), claims, suits, actions, damages, liability and expenses, occasioned wholly or in part by Company's failure to perform any of its obligations under the Service Agreement or Company's negligence, omission or fault, or the negligence, omission or fault of Company's agents, subcontractors, independent contractors, suppliers, employees or servants in connection with the Service Agreement, including, but not limited to, those in connection with loss of life, bodily injury, personal injury, damage to property, contamination or adverse effects on the environment, intentional acts, failure to pay any Subcontractors and suppliers, any breach of the Service Agreement, and any infringement or violation of any proprietary right (including, but not limited to, patent, copyright, trademark, service mark and trade secret).

C. City's Indemnification of PMA. Subject to the provisions and limitations of this Section, City hereby indemnifies and holds harmless PMA and each member, officer, and employee of PMA against any and all claims, losses, damages or liabilities, joint and several, to which PMA or any member, officer or employee of PMA or any member, officer or employee of PMA may become subject, insofar as such losses, claims, damages or liabilities (or actions in respect thereof) arise out of this Service Contract or the Service Agreement, unless the losses, damages or liabilities arise from an adjudication of bad faith, fraud or deceit of the member, officer or employee or PMA. In the event any claim is made or action brought against PMA, or any member, officer, or employee of PMA, PMA may request City assume the defense of the claim and any action brought thereon and pay all reasonable expenses incurred therein; or PMA may assume the defense of any such claim or action, provided, however, that counsel selected by PMA shall be approved by City, and further provided that City may engage its own counsel to participate in the defense of any such action. The defense of any such claim shall include the taking of all actions necessary or appropriate thereto.

13.14 Litigation Cooperation. If, at any time, the City becomes involved in a dispute or receives notice of a claim or is involved in litigation concerning the Biosolids Services provided under this Service Contract, the resolution of which requires the services or cooperation of PMA or the Company, and PMA or the Company is not otherwise obligated to indemnify and defend the City pursuant to the provisions for Indemnification of the City, PMA agrees and shall cause the Company to provide such services and to cooperate with the City in resolving such claim or litigation as additional services under this Service Contract the costs of which service shall be Reimbursable Costs.

13.15 Notice of Claims. If PMA or its Subcontractors receives notice of a legal claim against it in connection with this Service Contract, PMA shall and shall cause the Company to submit

appropriate written notice of such claim to its insurance carrier within the time frame required for submission of claims by the applicable insurance policy and, within ten (10) business days of receipt of notice of the claim, to the Responsible Official.

13.16 Non-Discrimination; Fair Practices. This Service Contract is entered into under the terms of the Philadelphia Home Rule Charter, as it may be amended from time to time, and in performing this Service Contract, PMA shall not and shall prohibit Company from discriminating or permitting discrimination against any individual because of race, color, religion, sex, sexual orientation, ancestry or national origin.

A. PMA shall and shall cause the Company, in performing under the Service Agreement, to comply with the provisions of the Fair Practices Ordinance of The Philadelphia Code (Chapter 9-1100) and the Mayor's Executive Order No. 4-86, as each may be amended from time to time, both of which prohibit, among other things, discrimination against individuals because of race, color, sex, sexual orientation, religion, national origin, ancestry, age, handicap (including, but not limited to, Human Immunodeficiency Virus infection), marital status, presence of children or source of income, in employment, housing and services in places of public accommodation. In the event of any breach of these provisions, the City may, in addition to any other rights or remedies available under this Service Contract, at law or in equity, suspend or terminate this Service Contract forthwith.

B. In accordance with Chapter 17-400 of The Philadelphia Code, as it may be amended from time to time, PMA shall require the Company to agree that its payment or reimbursement of membership fees or other expenses associated with participation by its employees in an exclusionary private organization, insofar as such participation confers an employment advantage or constitutes or results in discrimination with regard to hiring, tenure of employment, promotions, terms, privileges or conditions of employment on the basis of race, color, sex, sexual orientation, religion, national origin or ancestry, constitutes a substantial breach of this Service Contract entitling the City to all rights and remedies provided in this Service Contract or otherwise available at law or in equity.

C. PMA agrees and shall cause Company to cooperate with the Commission on Human Relations of the City ("Commission") in any manner which the Commission deems reasonable and necessary for the Commission to carry out its responsibilities under Chapter 17-400 of The Philadelphia Code. Company's failure to so cooperate shall constitute a substantial breach of this Service Contract entitling the City to all rights and remedies provided in this Service Contract or otherwise available at law or in equity.

D. PMA shall include the above non-discrimination and fair practice provisions in the Service Agreement all subcontracts or subleases relative to the Service Contract.

13.17 Americans With Disabilities Act. PMA understands and agrees that no individual with a disability shall, on the basis of the disability, be excluded from participation in this Service Contract or from providing services or materials under this Service Contract. By executing and delivering this Service Contract, PMA covenants to comply with all provisions of the ADA and all regulations promulgated thereunder, as the ADA and regulations may be amended from time

to time, which are applicable (a) to PMA and its Subcontractors; (b) to the benefits, services, materials, activities, facilities and programs provided in connection with this Service Contract; (c) to the City or the Commonwealth of Pennsylvania; (d) to the benefits, services, activities, facilities and programs of the City or of the Commonwealth; and (e) if any funds under this Service Contract are provided by the federal government, which are applicable to the federal government and its funds, benefits, services, activities, facilities and programs applicable to this Service Contract. Without limiting the applicability of the preceding sentence, PMA shall comply with the "General Prohibitions Against Discrimination," 28 C.F.R. Part 35.130, and all other regulations promulgated under Title II of the ADA, as they may be amended from time to time, which are applicable to the benefits, services, facilities, programs and activities provided by the City through contracts with outside contractors.

13.18 Northern Ireland Provisions.

A. In accordance with Section 17-104 of The Philadelphia Code, PMA by execution of this Service Contract certifies and represents that (i) PMA (including any parent company, subsidiary, exclusive distributor or company affiliated with Company) does not have, and will not have at any time during the Term of this Service Contract (including any extensions of the Term), any investments, licenses, franchises, management agreements or operations in Northern Ireland and (ii) no product to be provided to the City under this Service Contract will originate in Northern Ireland, unless PMA has implemented the fair employment principles embodied in the McBride Principles.

B. In the performance of this Service Contract, PMA agrees that it will not use any suppliers, Subcontractors or subconsultants at any tier (1) who have (or whose parent, subsidiary, exclusive distributor or company affiliate have) any investments, licenses, franchises, management agreements or operations in Northern Ireland or (2) who will provide products originating in Northern Ireland unless said supplier, subconsultant or Subcontractor has implemented the fair employment principles embodied in the McBride Principles.

C. PMA agrees and shall cause Company to cooperate with the City's Director of Finance in any manner which the said Director deems reasonable and necessary to carry out the Director's responsibilities under Section 17-104 of The Philadelphia Code. PMA expressly understands and agrees that any false certification or representation in connection with the Philadelphia Code 17-104 and any failure to comply with the provisions of the Philadelphia Code 17-104 shall constitute a substantial breach of this Service Contract entitling the City to all rights and remedies provided in this Service Contract or otherwise available at law (including, but not limited to, Section 17-104 of The Philadelphia Code) or in equity. In addition, PMA understands that false certification or representation is subject to prosecution under Title 18 Pa. C.S.A. § 4904.

13.19 Limited English Proficiency. PMA agrees that no individual who is limited in his or her English language proficiency shall be denied access to services provided under this Service Contract on the basis of that limitation. As a condition of accepting and executing this Service Contract, PMA shall and shall require all Subcontractors to comply with all provisions of Title VI of the Civil Rights Act of 1964, the President of the United States of America Executive

Order No. 12250, the Mayor of the City of Philadelphia's Executive Order "Access to Federally Funded City Programs and Activities for Individuals with Limited English Proficiency" dated September 29, 2001, and all regulations promulgated thereunder, as the Act and regulations may be amended from time to time, which are applicable (a) to PMA or its Subcontractors, (b) to the benefits, services, activities and programs provided in connection with this Service Contract, (c) to PMA or the City or the Commonwealth of Pennsylvania, and (d) to the benefits, services, activities and programs of the City or of the Commonwealth, and if any funds under this Service Contract are provided by the federal government, which are applicable to the federal government and its benefits, services, activities and programs. Without limiting the applicability of the preceding sentence, PMA shall comply with 45 C.F.R. 80 et. seq. and all other regulations promulgated under Title VI of the Civil Rights Act of 1964, as they may be amended from time to time, which are applicable to the benefits, services, programs and activities provided by the City through contracts with outside contractors.

13.20 Governing Law. This Service Contract shall be deemed to have been made in Philadelphia, Pennsylvania. This Service Contract and all disputes arising under this Service Contract shall be governed, interpreted, construed, enforced, and determined in accordance with the laws of the Commonwealth of Pennsylvania, without giving effect to principles of Pennsylvania law concerning conflicts of laws.

13.21 Forum Selection Clause; Consent to Jurisdiction. The Parties irrevocably consent and agree that any lawsuit, action, claim, or legal proceeding involving, directly or indirectly, any matter arising out of or related to this Service Contract, or the relationship created or evidenced thereby, shall be brought exclusively in the United States District Court for the Eastern District of Pennsylvania or the Court of Common Pleas of Philadelphia County. It is the express intent of the Parties that jurisdiction over any lawsuit, action, claim, or legal proceeding shall lie exclusively in either of these two (2) forums. The Parties further irrevocably consent and agree not to raise any objection to any lawsuit, action, claim, or legal proceeding which is brought in either of these two (2) forums on grounds of venue or forum non conveniens, and the Parties expressly consent to the jurisdiction and venue of these two (2) forums. The Parties further agree that service of original process in any such lawsuit, action, claim, or legal proceeding may be duly effected by mailing a copy thereof, by certified mail, postage prepaid.

13.22 Waiver of Jury Trial. PMA hereby waives and shall cause company to waive trial by jury in any legal proceeding in which the City is a party and which involves, directly or indirectly, any matter (whether sounding in tort, contract or otherwise) in any way arising out of or related to this Service Contract or the relationship created or evidenced hereby. This provision is a material consideration upon which the City relied in entering into this Service Contract.

13.22 Third Party Beneficiaries. The Company is a third-party beneficiary to this Service Contract. Otherwise, the rights and obligations of PMA and the City as enumerated in this Service Contract and the Transaction Agreements are for the sole and exclusive benefit of the City and PMA.

[SIGNATURE PAGE FOLLOWS]

City-PMA Service Contract

IN WITNESS WHEREOF, the parties have caused this Service Contract to be executed and delivered by their duly authorized officers or representatives as of the date first above written.

THE CITY OF PHILADELPHIA

By: _____
William Gamble
Procurement Commissioner

By: _____
Bernard Brunwasser
Water Commissioner

APPROVED AS TO FORM

By: _____
Law Department
Romulo L. Diaz, Jr.
City Solicitor

THE PHILADELPHIA MUNICIPAL AUTHORITY

By: _____
Name:
Title:

Attest

By: _____
Name:
Title:

APPENDICES

Table of Contents

- 1. Transition Period and Interim Period Scope of Work**
- 2. Class A Facilities Design/Build Scope of Work**
- 3. Odor and Air Emissions Control**
- 4. Project Schedule**
- 5. Project Plans and Specifications**
- 6. Acceptance Test Standards**
- 7. Company's Performance Standards, Measurements and Guarantees**
- 8. Class A Period Operation and Maintenance**
- 9. Class A Product Reuse and Disposal**
- 10. Government Permits and Approvals**
- 11. Financing Plan**
- 12. Insurance Requirements**
- 13. M/W/DSBE Participation**
- 14. Class A Period Buy Out Schedule**
- 15. City Contract Assigned to Company**

Appendix 1

Transition Period and Interim Period Scope Of Work

1.0 City/PMA Obligations or Actions

Where PMA is required under the Service Agreement to cause the City to take any action or to undertake any responsibility, those acts or responsibilities will be referred to in this Appendix as acts and responsibilities of the "City." Where the City has undertaken any obligation under the Service Contract, those obligations are also referred to in this Appendix as "City" obligations. Where PMA has authorized the City to receive, review or approve Company submittals these will be referred to in this Appendix as the "City" receipt, review or approval.

1.1 Before the Transition Period

(A) Transition Plan. On or before the Service Agreement Date, the Company shall provide to the City a proposed detailed plan to facilitate transition of responsibility for management of City Biosolids and to identify the various documents and other matters that must be completed by the Company and the City before the Commencement Date ("Proposed Transition Plan").

(B) Security Plan. On or before the Service Agreement Date, the Company shall provide to City a proposed detailed plan for security of the BRC Site and the Existing Facilities ("Proposed Security Plan"). Company recognizes that the BRC Site is a critical part of wastewater treatment for Philadelphia and many surrounding communities. At a minimum the Proposed Security Plan will require that the Company institute a program to insure that the BRC Site is closed to the public and that site access gates are closed and/or locked at all times. Only Company personnel, identified and approved visitors and subcontractors, and City personnel previously approved by City, shall be admitted to the BRC Site. The plan must prevent the unauthorized public from entering, either by driving or walking, onto the site.

1.2 The Transition Period

The Transition Period shall begin on the Service Agreement Date and shall end on the Commencement Date.

1.3 City Responsibilities During the Transition Period

1.3.1 City General Responsibilities

(A) Transition Plan. City shall respond with any questions or comments regarding the Proposed Transition Plan within fifteen (15) days of the Service Agreement Date, and the

FINAL VERSION

Company shall respond to such question or comments within seven (7) days of receipt. Out of such discussions the parties shall agree on a final transition plan (“Transition Plan”) within thirty (30) days of the Service Agreement Date. Notwithstanding the foregoing, City may authorize Company to begin certain Transition Period activities even prior to finalization of the Transition Plan.

(B) Security Plan. City shall respond with any questions or comments regarding the Proposed Security Plan within fifteen (15) days of the Service Agreement Date, and the Company shall respond to such question or comments within seven (7) days of receipt. Company shall submit a final security plan (“Security Plan”) within thirty (30) days of the Service Agreement Date. Notwithstanding the foregoing, City may authorize Company to begin certain Transition Period activities even prior to finalization of the Security Plan. Company shall update the Security Plan for the Construction Period and the Class A Period.

1.3.2 Operational Processing Capacity Demonstration. Within sixty (60) days of the Service Agreement Date, City shall perform dewatering operations, witnessed by the Company, for a period of five (5) days, to demonstrate the operational processing capacity of the Existing Facilities. If the operational processing capacity of the Existing Facilities is below the minimum operational processing capacity listed in this Section 1.3.2, the City shall make all municipally reasonable efforts to increase the operational processing capacity of the Existing Facilities to the minimum capacity listed herein prior to the Commencement Date, unless the parties agree that such efforts to increase the operational capacity may be completed after the Commencement Date.

Operational Processing Capacity Demonstration Guidelines

The following guidelines identify the minimum operational processing capacity to be demonstrated during the Operational Processing Capacity Demonstration. The guidelines will be used by the City and the Company to develop mutually accepted protocol for the Demonstration.

Facility Capacity

The Existing Facility (also referenced as the “Dewatering Facility”) will demonstrate the ability to dewater the equivalent of 70,000 DTPY of incoming City Biosolids with a capture rate of 93% as defined in Appendix 7 of the Service Agreement. For purposes of this Service Agreement, the “Dewatering Facility” shall be as defined in Section 1.6.16.

Sludge Receiving

Demonstrate

- Tank integrity
- All tank access ports are functional
- Tank level indicators functional

Sludge Feed Systems

Demonstrate

- At a minimum, 2/3 of all installed sludge feed pumps can flow material to pump design capacity
- At a minimum, 2/3 of all installed polymer feed pumps can flow material to pump design capacity.
- At a minimum, 2/3 of all installed grinders can operate for five consecutive days.

Polymer Make-up/Storage Systems

Demonstrate

- At a minimum, 2/3 of all installed tanks are functional and leak free.
- At a minimum, 2/3 of all tank level indicators function.

Centrifuges #1, #2, #3, #4

Demonstrate

- All process functions; mechanical, electrical, instruments up and to the conveyance system can operate trouble free for 5 consecutive days with a minimum of three (3) centrifuges in operation, whilst processing to full design capabilities for the same time period.

Centrifuges, #5, #6, #7, #8, #9, #10

Demonstrate

- During this same time frame used to demonstrate Centrifuges #1 through #4, four out of the remaining six centrifuges can operate continuously and process at least 75% of their original design capabilities.

Conveyance System

Demonstrate

- Both conveyors operate both locally and remotely. All safety alert and shut down devices are fully operational. All truck-loading plows operate remotely and locally.

Centrate System

Demonstrate

- Collection tank (clearwell) integrity.
- All level indicators function
- 2/3 of all installed pumping equipment can operate for 5 consecutive days trouble-free at 100% of original design flows.
- All piping from the centrifuges to the clearwell and from the clearwell pumps to the SW Sewage plant have been recently cleared of any process build-up.

Plant Auxiliary Equipment

Demonstrate

The recently installed oil-fired boiler Dewatering Facility heating system is fully operational.

All maintenance and repair activities have been completed to the Dewatering Facility elevator as noted in the past two years' inspection reports.

The Dewatering Facility's fire suppression systems, including all yard hydrants are fully operational.

1.3.3 **Existing Technical Documents.** Within thirty (30) days of the Service Agreement Date, the City shall provide Company with copies of BRC technical documents including any existing operating and maintenance manuals and permits for the Existing Facilities.

1.4 Company Responsibilities During the Transition Period

1.4.1 **Facility Manager and Staffing.**

(A) **Facility Manager.** Subject to City's review and approval of qualifications and experience, the Company will designate a full-time Facility Manager at least thirty (30) days before the Commencement Date who will serve as the Company's primary point of contact with City in accordance with Section 9.1 of the Service Agreement.

(B) **Staffing.** Company shall hire and train appropriate personnel (which may include former City personnel) to assume responsibility for the operational and maintenance obligations of the Company on the Commencement Date. Company shall provide a staffing plan to the City.

1.4.2 **Safety Program.** Within sixty (60) days of the Service Agreement Date, the Company will submit a comprehensive project-specific safety, health, and loss prevention program and employees substance abuse program for the Biosolids Services ("Safety Program") to the City, including the name and qualifications of the safety manager, safety goals, standards and guidelines, a framework for a safety review process, a schedule of regular meetings to address safety issues, a list of any forthcoming submittals that will become part of the Safety Program and submission schedule, and all information necessary to demonstrate that the Safety Program meets the requirements of applicable local, state, and federal regulations and insurance carriers for all phases of the Biosolids Services. City may review and comment on the Safety Program, but City shall have no right to approve the Safety Program or to direct the conduct of the Company, its personnel or Subcontractors in matters of safety.

1.4.3 **Public Relations.** The Company will prepare, regularly update, and implement a plan to foster positive public relations with respect to each aspect of the Biosolids Services ("Public Relations Plan"). The Public Relations Plan will be submitted to the

FINAL VERSION

City for review and comment not later than sixty (60) days after the Service Agreement Date.

1.4.4 Biweekly Meetings. The Company will meet with City on a biweekly basis to discuss the Biosolids Services conducted during the prior two (2) weeks and scheduled or planned future activities, including design, construction, operations and maintenance issues, environmental and permit compliance, invoicing issues, public relations and any other relevant issues. The Company will prepare meeting minutes and distribute them to the attendees in draft form five (5) working days after each meeting. The Company will incorporate City comments on the minutes and distribute final minutes with five (5) working days of receipt of City comments.

1.4.5 Emergency Spill Clean-Up Plan

(A) Prior to the Commencement Date and prior to the operation of any trucks on public roads during the Transition Period, the Company shall submit a plan to City for cleanup should any truck spill its contents, in whole or in part, on any public road. The Company will describe steps that will be taken in the event of a spill on state or non-state routes within two (2) hours of a spill incident on local routes. Any Subcontractor proposed by the Company for emergency clean-up efforts should be identified and its willingness to undertake this work demonstrated.

(B) If the Company begins trucking operations during the Transition Period, the Company shall implement its emergency spill clean-up plan in the event that any truck spills its load on a public road. The Company shall immediately verbally notify State Police or State Department of Transportation if the spill occurs on a state highway. The Company shall also immediately notify the appropriate state agency, PADEP, MDE or VDH. The Company shall notify the City immediately upon occurrence of the spill and shall keep City informed of the status of clean-up operations. The Company shall follow emergency spill or cleanup requirements of any permit.

1.4.6 Nuisance Mitigation Plan. Prior to the Commencement Date, the Company shall submit a plan for mitigating nuisances associated with the handling and land application of City Biosolids, Dewatered City Biosolids and Class B Product. The Company must address how it will minimize odors in the event that Class B Product cannot be incorporated the same day it is delivered to a land application site, including equipment and materials intended to be used under the Site Acquisition Plan as defined in Section 1.4.7 of this Appendix. The Company must address how it will minimize odors during the making of mine-mix. The Company shall also describe, as appropriate, information in its plan for vehicle cleaning, hours of operation, and control of public access, as may be necessary to fully describe nuisance mitigation.

1.4.7 Site Acquisition Plan. Prior to the Commencement Date, the Company shall submit a plan for obtaining permits for agricultural utilization sites ("Site Acquisition Plan"). Included in this plan should be information regarding the Company's site selection method and public relations plan. Specific information should include farms identified for biosolids utilization under this Service Agreement, including the state,

FINAL VERSION

county, site number, total acres and permit number. The plan will also identify the agricultural districts in which the Company intends to solicit farmer participation.

1.4.8 Interim Period Operation Plan. Prior to the Commencement Date, the Company shall submit a plan detailing how it will operate the Existing Facilities during the Interim Period (“Interim Period Operation Plan”). Such Interim Period Operation Plan shall include a plan for the continued training of personnel involved in the Biosolids Services, including operation and maintenance of the Existing Facilities (“Training Plan”).

1.4.9 Existing Facilities Operations and Maintenance Manual. Prior to the Commencement Date, the Company shall revise material provided by the City and/or write an operations and maintenance manual for the Existing Facilities, as referenced in Section 4.3(A) of the Service Agreement.

1.5 Interim Period

Activities described in the Transition Period shall continue during the Interim Period, as applicable, and will be updated as appropriate.

1.5.1 Interim Period Operations Assumptions. The Company assumes the following for the Interim Period for purposes of operations:

(A) Processing Capacity. Maximum quantity of City Biosolids delivered shall be 70,000 Dry Tons/Contract Year, but the Company shall process City Biosolids in excess of such quantity as Nonconforming City Biosolids.

(B) Dewatering Operation:

(1) Cake Dryness, Design Average	30% Total Solids
(2) Number of centrifuges installed	10 Existing
(3) Number of Liquid Storage Tanks	3 Existing
(4) Total Liquid Storage Capacity	3 million gallons
(5) Average Annual Liquid Sludge Total Solids Content	2.50%/ ± 0.50%
(6) Maximum Total Solids (based on 24 hour composite)	6 .00%
(7) Minimum Total Solids (based on 24 hour composite)	1.50%

(C) Class B Land Application & Disposal Programs. The Class B and application and disposal programs are generally designed to operate at 800-900 Wet Tons per day for five (5) days per week of operation.

1.5.2 Interim Period Pricing Assumptions. The Company assumes the following during the Interim Period for purposes of pricing:

(A) The existing Dewatering Facility is transferred to the Company in full operational order, in accordance with Section 1.3.2;

FINAL VERSION

(B) The Company implementation plan calls for a reintroduction of Class B Product into strip mine locations. In order to facilitate this reintroduction, the Company intends to make “mine mix” as previously formulated by City. Therefore, the Company requires a backlog of Unscreened Compost, in order to mix with the Class B Product. City will provide not more than 55,000 tons of such material left on the BRC Site upon the shut down of the compost operations;

(C) City shall complete the heating modifications to Dewatering Facility and the HVAC Ventilation in the Dewatering Facility;

(D) City shall pay the Company for removal and disposal of Excess Unscreened Compost. Prior to the Commencement Date, the parties shall obtain independent verification of the amount of Excess Unscreened Compost [Needs definition] left by the City on the BRC Site;

(E) City shall pay the Company for removal and disposal of all wet tons of Class B Biosolids and Nonconforming Class B Biosolids left on the BRC Site. Within five (5) days of the Commencement Date and prior to any addition, removal or disposal by Company, the parties shall obtain independent verification of the amount of wet tons of Class B Biosolids and Nonconforming Class B Biosolids left by the City on the BRC Site;

(F) City shall pay the Company for loading of Screened Compost left on the BRC Site and any other required services including uncovering and windrowing. Consistent with regulatory requirements, City will sample and analyze the Screened Compost left on the BRC site. Prior to any loading by Company, the parties shall obtain independent verification of the amount of Screened Compost left by the City on the BRC Site.

1.6 Company's Interim Period Responsibilities

1.6.1 General Services

- (A) City Biosolids reception and storage;
- (B) Dewatering of City Biosolids, including associated subsystems and material handling;
- (C) Dewatered City Biosolids transportation, temporary storage, reuse and disposal;
- (D) Preparation, storage, transportation and reuse of mine mix;
- (E) Operated Facility infrastructure management and maintenance within the BRC Site;
- (F) Implement Odor Control procedures set forth in Section 3.2 of Appendix 3.

FINAL VERSION

1.6.2 Major Activities

- (A) take over the existing Dewatering Facility, including operation, maintenance, repair and capital improvements;
- (B) divert 100% of the Dewatered City Biosolids to land application, mine reclamation and/or landfill utilizing existing Truck Loadout Bay (“TLB”) adjacent to the Dewatering Facility;
- (C) Utilize unscreened compost for mine mix;
- (D) Utilize or dispose of Class B Biosolids left on the BRC Site at the end of the Transition Period;
- (E) convert the existing compost drying structures into a Temporary and Emergency Cake Transfer and Storage Facility (“CTSF”) capable of storage of no more than 10,000 tons of Class B Product;
- (F) take over the existing Truck Wash facility (“Truck Wash”) and existing warehouse (“Warehouse”);
- (G) cleaning grates and stormwater channels and pipes on the BRC Site;
- (H) provide security for the BRC Site;
- (I) prevent and extinguish fires;
- (J) maintain existing fire hydrants with properly functioning backflow prevention or air-gap separation devices; and
- (K) windrow and loadout screened compost.

1.6.3 Dewatering Operation

After the City transfers the Dewatering Facility to the Company, the Company shall be responsible for:

- (A) reception, measurement and storage of incoming City Biosolids;
- (B) dewatering centrifuge operation, including feed pumps and controls;
- (C) polymer preparation and supply system;
- (D) pumping centrate and miscellaneous liquid discharges to the City;
- (E) Dewatered City Biosolids conveyance and truck loadout;
- (F) equipment maintenance, repair, capital improvements and upgrades in accordance with a Company schedule;
- (G) boiler house operation;
- (H) personnel recruitment and training.

1.6.4 Dewatered City Biosolids. A portion of Class B Product will be used to make the mine mix on-site. Typically, the Class B Product will be loaded at the TLB and transported to the CTSF as required and then to application sites or landfills. Class B Product for land application and mine reclamation will be transported to permitted sites. The truck units will be inspected, licensed and appropriately marked, as required, for the purpose of transporting dewatered biosolids. The dump trailers will be equipped with full

FINAL VERSION

rear mud flaps. Highway regulations, weight limits and other ordinances will be identified for each haul route and will be observed.

1.6.5 Class B Operations. The Company will assume responsibility for dewatering operations at the Dewatering Facility and for management of City Biosolids, from Commencement Date until ATSA Date. The Company may continue to utilize existing City contractors and suppliers, as well as substantially expanding the Company's own programs for the Interim Period. The Company will also arrange for multiple landfill capacity for backup purposes. The Class B Product and other Dewatered City Biosolids will be reloaded at the TLB and transferred either directly to land application, mine reclamation or landfill, or stored temporarily at the CTSF.

1.6.6 Operating Reports

(A) The Company will, in addition to any operating data provided separately, provide a monthly report to the City that includes the following:

- (1) Quantity of Class B Product, on a Wet Ton basis, which is delivered, dewatered from City Biosolids, processed, reused and disposed of by the Company, including the processing method and the reuse and disposal locations;
- (2) Summary of significant operational and maintenance activities from the preceding month (including departures from standard operating procedures and corrective measures) and forecast for the next three-month period;
- (3) Narrative description of operational procedures and any operational changes;
- (4) A summary of accident reports and other safety-related issues;
- (5) A summary of staff and an updated organization chart, noting all filled and vacant positions; and
- (6) A summary of electricity, natural gas, digester gas, alternative fuel, and chemical usage for the prior month.

The monthly operating reports will also include such additional information that the City may reasonably request.

(B) The Company will submit to City an annual report no later than sixty (60) days after each Contract Year. The content of such annual report will be as agreed by the City and the Company.

(C) The Company will, in addition to any operating data provided separately, provide to City a monthly equipment status report.

(D) The Company will, in addition to any operating data provided separately, provide the City with real time but read-only access to computer monitoring of the three storage tanks, the three flow lines (A flow line, B flow line, and Centrate flow line), and the NEWPCP barge transfer meter.

FINAL VERSION

1.6.7 Biosolids Measurement. There are existing flowmeters on the liquid biosolids delivery lines. The Company assumes these flowmeters are operational and of sufficient accuracy for billing purposes. The flowmeters shall be calibrated by the Company at any time that the Company has evidence that a flowmeter is out of calibration but at least once a year by a certified company. The Company will follow procedures outlined in Appendix 7 to determine the quantities of City Biosolids and Dewatered City Biosolids. If the Company determines that the measurement equipment is not accurate, the Company shall submit a plan to the City for approval to upgrade the measurement system for billing purposes.

1.6.8 Governmental Approvals. Company shall be responsible for obtaining and maintaining site approvals and permits, as identified in Appendix 10, appropriate for and applicable to the Interim Period and for submitting all required information and reports to local state and federal regulatory agencies.

1.6.9 Monitoring and Testing

(A) The Company will be responsible for (i) daily analyses performed for the purpose of process control and system operations and maintenance (including implementation of the process monitoring protocol currently utilized by the City in its operation of the Existing Facilities, as such protocol may be amended by the Company and approved by the City), (ii) the performance of all sampling and laboratory analyses required to determine compliance with Applicable Law, and (iii) the performance of all sampling and delivery of such samples to the City laboratory to determine compliance with the Performance Requirements as well as accurate preparation of invoices of the Interim Service Fee and the Service Fee. The City may, at any time, request, or itself perform, additional sampling and independent analyses to verify Company testing.

(B) The Company shall provide quality assurance and quality control (“QA/QC”) testing in conjunction with laboratory work. A description of the QA/QC program and supporting analytical results shall be maintained in orderly files by Company’s laboratory and shall be summarized in an annual report and otherwise made available upon request by the City. The Company shall provide an electronic copy of all laboratory records on demand for auditing and other purposes.

1.6.10 Notice of Necessary Information. The Company will prepare a Notice and Necessary Information (NANI) form certifying to the preparation of the biosolids in conformance to Federal and State regulations for signature by the City.

1.6.11 Maintenance Management and Databases

(A) The Company shall implement a computerized maintenance management system (“CMMS”) to track and administer (including record keeping) maintenance activities and spare parts inventories.

(B) The Company shall perform all testing as may be required by warranties, commercial or industrial standards and Applicable Law. The Company shall ensure that

FINAL VERSION

all protective shields, screens, and other safety devices are in place and fully functional at all times for the protection of personnel. The Company shall set up a separate database containing all biosolids equipment included in the Existing Facilities. All new equipment shall be set up in the database prior to generating preventive maintenance work orders.

1.6.12 Predictive Maintenance. The Company shall conduct predictive maintenance to minimize the likelihood of machinery failure and to extend the useful life span. Process variables, such as temperature and amperage, shall be tracked by the Company using the CMMS to identify statistical trends that predict equipment failure. These analyses will identify present and potential problems and predict when corrective action should be taken by the Company.

1.6.13 Preventive Maintenance. The CMMS shall alert the Company's maintenance personnel to investigate and make any necessary adjustments or repairs in order to avoid equipment failure. The Company's preventive maintenance shall include, but is not limited to:

- (A) lubrication;
- (B) maintenance of oil levels;
- (C) drainage of condensate;
- (D) verification of proper operation;
- (E) inspection and replacement of normal wearing parts; and
- (F) overhauls required by manufacturer or past history.

1.6.14 Renewal and Replacement. The Company shall be responsible for renewal and replacement of equipment and fixtures comprising the Existing Facilities and shall perform such additional renewal and replacement of the Existing Facilities as may be necessary for the Company to provide the Biosolids Services and to meet the Contract Standards. Company shall use commercially reasonable judgement in determining whether any equipment is to be renewed or replaced. The renewal and replacement of equipment shall be of a quality and durability equal to or greater than the equipment being replaced. Equipment renewal shall restore the equipment's performance to a level equal to or greater than its level on the Commencement Date. Equipment replaced or renewed shall also meet, at a minimum, prudent industry practice, the original engineering design specification, and the requirements defined in the manufacturer operations and maintenance manual.

1.6.15 Building and Grounds. The Company shall maintain a high state of cleanliness in all aspects of its operations. The biosolids handling area shall be cleaned daily. Vehicles and solids containers shall be cleaned at least weekly. The Company shall maintain the BRC Site grounds and landscaping in an aesthetically attractive and clean condition in accordance with all applicable provisions of the Lease.

1.6.16 Dewatering Facility. The Dewatering Facility shall be the responsibility of the Company. It contains liquid storage tanks; dewatering centrifuges; polymer supply system; pumping and material handling equipment; HVAC; electrical; instrumentation

FINAL VERSION

and controls; offices; maintenance shops; men's and women's locker facilities; laundry facilities and a lunchroom. The Dewatering Facility also contains one control room on the third floor, equipped with television monitors, read-outs, computers, alarms and controls of the major equipment in the building. The Dewatering Facility has a sump pumping system on the lower floor and a hoisting system for the centrifuges on the top floor. New water heaters were installed and construction of new boilers largely completed in 2004. The Dewatering Facility shall be operated in a manner to achieve the percent capture requirement and flow and solids set forth in Appendix 7.

1.6.17 Dewatered Biosolids Truck Loadout Bay. The TLB shall be the responsibility of the Company. It is a part of the Dewatering Facility containing two lanes for truck loading. The Company will make necessary upgrades to the TLB to meet its requirements.

1.6.18 Mixing Building. The Mixing Building shall be demolished by the Company. The mixing equipment, dewatered biosolids and woodchip conveyance and other equipment shall be dismantled by the Company and returned to the City.

1.6.19 Receiving Building. The Receiving Building shall be demolished by the Company.

1.6.20 Compost Drying Structures. The Compost Drying Structures shall be the responsibility of the Company. The Compost Drying Structures shall be converted by the Company into temporary and emergency Cake Transfer and Storage Facility ("CTSF").

1.6.21 Instrument and Maintenance Building. The Instrument and Maintenance Building shall be the responsibility of the Company. The Instrument and Maintenance Building contains offices, I&C hardware and software, and spare parts inventory. The Instrument and Maintenance Building shall be transferred to the Company in operational condition and in compliance with O&M manuals and manufacturers' specifications.

1.6.22 Truck Wash. The Truck Wash shall be the responsibility of the Company. The Truck Wash shall be transferred to the Company in operational condition and in compliance with O&M manuals and manufacturers' specifications.

1.6.23 Construction Laydown Area. Compost, biofilter and drying structure aeration fans, ductwork, electrical and controls shall not be removed by the Company, except those that are located in the area which occupies the alignment of the proposed construction laydown area.

1.6.24 Warehouse. The 10,000 square foot Warehouse shall be the responsibility of the Company. The Warehouse containing offices, mechanized spare parts storage, and facility and spare part inventory shall be transferred to the Company in operational condition.

FINAL VERSION

1.6.25 Woodchip Feeders and Supply System. Woodchip feeders and air supply system shall be demolished by the Company.

1.6.26 Rolling Stock. The Company shall maintain all rolling stock leased from City or otherwise acquired in accordance with Section 4.10 of the Service Agreement.

1.6.27 Disposal Documents. The Company shall furnish to City, upon request, all documentation regarding the proper disposal of all demolished buildings, demolished equipment, waste material, and debris.

1.6.28 Utility Infrastructure

(A) The Company shall be responsible for all potable water lines, meters, and backflow prevention device from the City's water main to the Existing Facilities and to any new facilities constructed by the Company.

(B) The Company shall be responsible for all stormwater and drainage pipes on the premises leased to the Company and shall take reasonable steps to minimize solids returned through the stormwater drains to the Southwest Plant.

(C) The Company shall be responsible for any natural gas lines or telephone phone lines on the premises leased to the Company.

(D) The Company shall install and be responsible for the new digester gas line.

(E) If the Company needs to modify the two electrical feed lines from the SWWPCP to the BRC sub station to supply additional power, those modifications will be the responsibility of the Company.

(F) The Company shall be responsible for any polymer build-up in the first 150 feet of the underground portion of the sixteen-inch centrate line to the SWWPCP.

(G) The Company shall maintain City access to BRC operations information.

1.6.29 Existing Facilities

(A) The Company shall operate all components of the Existing Facilities in accordance with the Contract Standards, including the O&M Manual, Applicable Law, and other requirements of the Service Agreement. The Company shall provide computer-based management, process control and maintenance management systems; quality assurance systems; laboratory analysis, quality analysis and quality control; odor and noise control; security of sites, facilities and equipment; and building and grounds up-keep and maintenance.

(B) The Company shall maintain the Existing Facilities to ensure their long-term reliability and preservation. Maintenance shall be accomplished in accordance with manufacturers' specifications and recommendations, O&M manuals, and generally accepted industry standards. Company shall employ predictive, preventive and corrective

FINAL VERSION

maintenance programs, enforce existing equipment warranties, and maintain all warranties on equipment.

1.6.30 Land Application of Class B Product

(A) The Company will manage the Class B Product and other Dewatered City Biosolids during the Interim Period Program through a matrix of reuse/disposal options. These options include land application, mine reclamation, and landfill in Pennsylvania, Maryland, Virginia, and other states.

(B) The Company will assume complete responsibility for Interim Period reuse/disposal operations to manage all Class B Product and all other materials generated or remaining at the BRC Site (Such as Dewatered City Biosolids that do not meet Class B Product criteria due to Nonconforming City Biosolids or due to Company Fault). Availability of reuse options is limited by public opposition, crop rotations, seasonal weather patterns and short-term weather impacts. When reuse sites are open for application, biosolids will be transported and applied as produced. When reuse sites are unavailable, biosolids will be stored at application sites in permitted temporary storage areas or at the CTSF. In addition, when necessary, biosolids will be transported and disposed at permitted landfills.

1.6.31 Land Application Requirements

(A) The Company's project management approach will be to emphasize communication and coordination with the City's staff to provide seamless management of the Interim Period project under all conditions and weather constraints.

(B) The Company shall meet with participating farmers individually prior to any biosolids application to their farms. The Company must review with farmers the requirements for biosolids management in Pennsylvania, Maryland, Virginia, or other states, particularly as they apply to nutrient management and conservation plans. The Company shall utilize soil samples and biosolids analyses to evaluate nutrient management for the next season's crop. The Company shall calculate and present to the farmer total nitrogen, phosphorus and potassium supplied by the biosolids. This information should determine the need for supplemental fertilizer, and recommendations shall be made by the Company based on the farmer's yield goals.

(C) The Company will be required to have a minimum of one site supervisor available at all times at each operational site. Each site supervisor shall have a full knowledge of pertinent state regulations and permit requirements and shall have demonstrated successful experience with biosolids application operations. It is preferred that the supervisor shall have university training in an agricultural discipline or an equivalent combination of education and experience.

(D) The Company will be responsible for preparing daily log sheets and in submitting, as necessary, to meet state requirements, such records to the appropriate officials, which may be the county Conservation District or to the appropriate state agencies. The

FINAL VERSION

Company is responsible for assuring that, in accordance with state regulations, all site management restrictions governing placement of biosolids are met, such as setbacks from property lines and from waterways.

1.6.32 Transportation

(A) The Company shall be responsible for all trucks having gasket watertight sealed and positive locking tailgates and impermeable tarp covering during the transport of material. Mesh tarps are not acceptable due to the higher risk of spillage and water infiltration. The Company shall be responsible for all trucks being washed on a routine basis. The Company shall be responsible for all permits, licenses, bonds, tolls, fees, and fines associated with the transportation of Product and other City Biosolids over public roadways. The Company is responsible for obeying all laws regarding the transportation of biosolids materials over state, county and local roadways (for example, weight limitations and placards).

(B) The Company must have a spill plan. This spill plan will be placed and kept in all trucks used to transport City Biosolids. All trucks shall be properly placarded as required by federal, state or local laws and regulations.

(C) The Company must provide certain management procedures connected with the transportation City Biosolids, such as tonnage reports, weight slips and other information requested by the City for administrative coordination.

1.6.33 Application and Incorporation

(A) Prior to the application of Product, the Company shall if required by the state, measure soil pH of each field to which biosolids are planned for application to ensure that the pH of the soil at each field meets or exceeds levels required by state regulation.

(B) Application rates shall not exceed those determined in consultation with the farmer as part of the nutrient management plan, neither shall rates exceed those established as maximum rates by state guidelines. Rates shall be confirmed by flagging or staking plots of known acreage within the site boundaries and by applying appropriate total tonnage to each plot as confirmed by net truck weight measurements. The Company shall provide the landowner with advice on the maximum allowable supplemental nutrients which may be applied to fields in addition to the nitrogen supplied in the biosolids, in accord with the nutrient management plan developed for the site.

(C) All setback distances from wells, streams, surface waters, occupied dwellings, and property boundaries shall be marked accordingly by flagging or staking prior to application of biosolids products.

(D) The Company shall spread and incorporate Product in accordance with state regulation.

FINAL VERSION

1.6.34 Environmental Monitoring. The Company shall provide labor, materials, and laboratory services to meet environmental monitoring requirements. The following monitoring tasks are, or may be, required.

- (A) Soil samples for all sites are to be collected in accordance with the appropriate state agency's permitting requirements.
- (B) The Company shall take such additional samples of Class B Product delivered to farm sites as may be useful to demonstrating compliance with various state regulations. This may include moisture and nutrient analyses. Such analytical work shall be performed by a certified laboratory. All results shall be submitted to the state as required with a copy to City. All costs for sampling and analysis shall be borne by the Company.
- (C) Groundwater sampling may be, in special circumstances, required at application sites. The Company will perform groundwater sampling as directed by the state. Whereas the states of Pennsylvania, Maryland and Virginia are considering a change in regulation governing agricultural phosphorus, the Company may be directed by one or more states to conduct such analysis of biosolids, soil, crops and water as may contribute to an improved understanding of phosphorus movements in the environment of biosolids application sites.

1.6.35 Site Acquisition

- (A) The Company will be required to supply farms for agricultural utilization of biosolids products in Pennsylvania, Maryland, Virginia or other states, sufficient to meet the anticipated requirements of the Company to provide Biosolids Services under this Service Agreement. City expects the Company to identify farms that employ good agricultural management activities, specifically implemented conservation and nutrient management plans. Further, the City expects that the Company will provide evidence that the application of Product to the farm meets sound agronomic requirements at each farm.
- (B) The Company will be responsible for all costs and activities associated with the acquiring approved utilization sites. Permit documents may be held in the name of the owner or the Company.
- (C) The Company shall also provide to the City, in a timely manner and upon request, all such information about existing and proposed agricultural utilization sites which may be required by the USEPA to be furnished in connection with a "sludge-only" NPDES permit application for the operation of the BRC Site.

1.6.36 Public Relations. Due to the nature of biosolids application projects, City may call upon the Company, from time to time, to answer inquiries, give presentations, and develop reports which enhance the image of City Biosolids and increase acceptance of City Biosolids from Philadelphia. The Company shall participate in agricultural and

FINAL VERSION

environmental shows open to the public in Pennsylvania, Maryland, Virginia, and other states for the purpose of explaining benefits of biosolids recycling.

1.6.37 Reports and Records of Biosolids Applications. The Company will be required to develop and maintain operational records of its biosolids applications in an accurate and timely manner. The records shall meet all requirements imposed by appropriate state regulations, and shall also meet all federal requirements of 40 CFR Part 503, Federal Biosolids Use and Disposal Standards, and of whatever “sludge-only” NPDES permit may be issued by the USEPA to the BRC.

1.6.38 Company Assessment. The Company shall regularly assess performance and implement operational changes and adjustments in routine operating procedures as necessary and appropriate to maintain and improve the quality of the Biosolids Services. The Company shall periodically report to the City on the results of such assessments and changes in operations.

1.6.39 Labor Requirements. The Company shall be required to provide qualified operators and supervisory personnel at sufficient levels for the performance of work and shall offer such evidence as is required that all operators meet applicable local, state, and federal regulations.

1.6.40 Electrical Requirement. The Company shall cooperate in meeting the 10 (ten) megawatt electrical demand requirement under PECO’s LILR.

1.7 City’s Interim Period Responsibilities

1.7.1 General Operations

(A) The City shall deliver City Biosolids to the BRC Site. The City Biosolids will be delivered to the BRC Site from three water pollution control plants in Philadelphia: The Northeast; Southeast and Southwest Plants, owned and operated by the Philadelphia Water Department (PWD). The Northeast Water Pollution Control Plant (“NEWPCP”), located near Frankford Creek, serves the northeast region of Philadelphia and adjoining northern suburbs and has a design average flow of 210 MGD. The Southeast Water Pollution Control Plant (“SEWPCP”), located near the Walt Whitman Bridge, serves the southeastern and central regions of Philadelphia with a design average flow of 112 MGD. The Southwest Water Pollution Plant (“SWWPCP”), located adjacent to the BRC and the Philadelphia International Airport, serves the western and southern regions and portions of the west suburbs of Philadelphia with a design average flow of 200 MGD. The three water pollution control plants employ conventional primary physical and secondary biological treatment of wastewater.

(B) The liquid biosolids from the three water pollution control plants are first thickened and then stabilized by mesophilic anaerobic digestion at the plants. Biosolids from the SEWPCP are pumped to the SWWPCP and combined for treatment by

FINAL VERSION

digestion. The combined biosolids are digested and then pumped, via two ten-inch force mains (Line A and Line B) directly to two holding tanks inside the Dewatering Facility at the BRC. The "A" line is used to pump liquid biosolids from the extra storage tanks located at the SWWPCP, which are used for storage over weekends and holidays, when dewatering is not operational. Line "B" is used for regular daily flow from SWWPCP every day. The flow rate in this line may vary from 600 to 1500 GPM.

(C) The biosolids from the NEWPCP are digested at the plant and then transported each day via two barges on the Delaware River to the Docking Facility located along the Schuylkill River just east of the site. Each of the barges has the capability to transport approximately one million gallons of biosolids. The barges unload at the Docking Facility and pump the biosolids via an eighteen-inch force main directly to one holding tank inside the Dewatering Facility at the BRC. The barge typically takes three to three and one-half hours to discharge approximately 850,000 – 900,000 gallons. There are two pumps on the barge which are rated at 4,000 GPM each, so the maximum flow may reach 8,000 gallons GPM if both pumps are operational.

(D) The City anticipates that the foregoing general conditions will continue during the Transition Period, Interim Period, and the entire Term of the Service Agreement.

1.7.2 Major Activities

- (A) City shall leave on the BRC Site not more than:
- (1) 55,000 tons of Unscreened Compost to be used for Company's "mine mix" program;
 - (2) approximately 10,000 wet tons of Class B Biosolids; and
 - (3) all City processed Screened Compost left at the BRC Site at the end of the Transition Period.
- (B) City shall minimize the amount of Class B Biosolids and Screened Compost left on site at the end of the Transition Period;
- (C) City shall transfer the Dewatering Facility to the Company in operational condition in accordance with the guidelines set forth in this Appendix 1;
- (D) City shall deliver the City Biosolids that are to be processed and managed by the Company to the BRC;
- (E) City shall deliver an adequate amount of process and potable water from the SW plant at no charge including pumping and maintenance of lines as called for in Section 1.7.10;
- (F) City shall receive centrate and other Return Flows, as outlined in Appendix 7, from the Operated Facilities at no charge;
- (G) City shall remove existing rolling stock not transferred to Company under the Lease;
- (H) City shall manage stormwater outside the BRC Site;
- (I) City shall maintain roads and landscaping outside the BRC Site;

FINAL VERSION

- (J) City shall maintain existing security fence, gates, parking, external lighting outside the BRC Site;
- (K) City shall complete the HVAC ventilation and heating modifications to the Dewatering Facility; and
- (L) City shall maintain infrastructure on City's side of utility demarcation, as outlined in Section 1.7.10 of this Appendix.

1.7.3 Permits. City shall cause City to be responsible for obtaining and maintaining permits as identified in Appendix 10.

1.7.4 Operation and Maintenance Center. The Operation and Maintenance Center shall remain the responsibility of the City.

1.7.5 Compost Screening System, Control Tower, and Personnel Building. The Compost Screening System, the Screening Control Tower, and the Screening Personnel Building shall remain the responsibility of the City.

1.7.6 Truck Scales and Scale Control House. Truck Scales and Scale Control House shall remain the responsibility of the City until such time it ceases operation of the scales. The Truck Scales and Scale Control House shall be transferred to the Company when the City begins operation of a new scale at the SWWPCP.

1.7.7 Fuel Storage and Supply Station. The Fuel Storage and Supply Station shall remain the responsibility of the City, including fuel pumps and associated underground storage tanks.

1.7.8 Barge Docking Facility. The Barge Docking Facility along the Schuylkill River and Sludge Pumps and Pipelines to the BRC shall remain the responsibility of the City

1.7.9 Technical Documents. City shall transfer to the Company any copies of BRC technical documents, including operating and maintenance manuals and permits for the Existing Facilities, which were not transferred to Company during the Transition Period.

FINAL VERSION

1.7.10 Utility Infrastructure

(A) The City shall be responsible for the City's two (2) ten-inch sludge transfer lines (lines A and B) from the SWWPCP and the eighteen-inch sludge transfer line from the City's barge unloading facility up to the point at which it reaches the foundation wall of the Dewatering Facility.

(B) The City shall be responsible for the City's sixteen-inch centrate line to the SWWPCP, 150 feet outside of the foundation wall of the Dewatering Facility.

(C) The City shall be responsible for the City's eight-inch plant water line from the SWWPCP up to the foundation wall of the Dewatering Facility .

(D) The City shall be responsible for the City's two (2) electrical feed lines from the SWWPCP to the BRC sub station.

(E) The City shall be responsible for the City's eight-inch plant water line from the SWWPCP up to the foundation wall of the Company's Facilities.

1.8 City Access to Facility

Access to the Facility shall be as set forth in Section 4.11 of the Service Agreement.

Appendix 2

Class A Facilities Design/Build Scope of Work

2.0 City/PMA Obligations or Actions

Where PMA is required under the Service Agreement to cause the City to take any action or to undertake any responsibility, those acts or responsibilities will be referred to in this Appendix as acts and responsibilities of the “City.” Where the City has undertaken any obligation under the Service Contract, those obligations are also referred to in this Appendix as “City” obligations. Where PMA has authorized the City to receive, review or approve Company submittals these will be referred to in this Appendix as the “City” receipt, review or approval.

2.1 Class A Facilities Scope of Work

The Company shall design, permit, finance, construct, and test the Class A Facilities and modify the Existing Facilities in compliance with this Service Agreement, including the Project Drawings in Appendix 5, the Project Schedule in Appendix 4, the Design Requirements in this Appendix 2, Applicable Law, the Contract Standards, and all environmental and other permits during construction. All Design and Construction Work pertinent to the Class A Period shall be implemented during the five year Interim Period.

2.2 Process Design Basis

The Major Design Criteria for the Class A Facilities are as follows:

2.2.1 Processing Capacity: Maximum quantity of Dewatered City Biosolids delivered shall be 65,000 Dry Tons per Contract Year

2.2.2 Dewatering Operation

(A)	Cake Dryness, Design Average	28% Total Solids
(B)	Number of centrifuges	ten (10) (Existing)
(C)	Number of Liquid Storage Tanks	three (3) (Existing)
(D)	Liquid Storage Capacity, Total	3 million gallons
(E)	Average Annual Liquid Sludge Total Solids Content	2.50%/ ± 0.50
(F)	Maximum Total Solids (based on 24 hour composite)	6.00%
(G)	Minimum Total Solids (based on 24 hour composite)	1.50%

2.2.3 Thermal Drying Operation

(A)	Class A Product	93% Total Solids
(B)	Processing Capacity	65,000 Dry Tons/year
(C)	Number of Drying Trains	two (2)

FINAL

(D)	Drying Train Manufacturer & Model	Andritz DDS 110
(E)	Type of sludge	Anaerobically Digested
(F)	Primary Fuel	Natural Gas
(G)	Secondary Fuel	Digester Gas
(H)	Alternate Fuel	#2 Fuel Oil
(I)	Mode of Operation	5-6 days/week, 24hr/day
(J)	Number of Product Storage Silos	three (3)
(K)	Class A Product Storage Capacity, Total	1,800 Tons

2.3 Design Assumptions

The following are major design assumptions with regards to Class A Design/Build Work and pricing for same:

- (A) Non-hazardous soils excavated during construction shall be used for backfilling or placed on the existing BRC site. No landfilling of such soils is included.
- (B) Company shall design for an annual average use of Digester Gas at thirty percent of the total thermal requirement of the Class A Facilities.

2.4 Modifications to Existing BRC Facility

The Company shall perform the following modifications to the Existing Facilities:

- (A) Reuse of existing belt conveyors and addition of new conveyors to deliver cake from the Dewatering Facility to the Thermal Drying Facility (“TDF”) through a new extended conveyor room.
- (B) Upgrade of the existing Truck Loading Bay (“TLB”) with the addition of four roll-up doors at the entrance and exit of each of the two lanes; two additional roll-up doors in the Dewatering Facility will also be replaced.
- (C) New Odor Control Scrubber System to control air emission and odors from the Dewatering Facility and the TDF.

2.5 New Buildings and Infrastructure

The Company shall design and construct the following new buildings and infrastructure:

2.5.1 Thermal Dryer Facility

- (A) The TDF building will be designed and constructed using materials and methods consistent with applicable codes and the City’s RFP to assure a minimum 25-year life. The TDF building will be a steel-framed structure using non-combustible materials to satisfy applicable building code requirements for Type II B construction (IBC Table

503). The ground level will comprise Process Area, Control and MCC room and Fire Pump room. The Process Area is classified as F-1 Industrial Moderate Hazard, according to IBC, and as Class 2, Division 2, according to NFPA 820 and NFPA 499. Electrical and Control Rooms are classified as F-2 (Factory Industrial Low Hazard). The digester gas trap room is Class 1, Division 1. The building will be sprinkled for fire protection and equipped with fire alarm with the exception of the electrical room which does not require sprinklers.

(B) The Thermal Dryer Facility will include:

- (1) Two Andritz model DDS 110 drying and pelletizing trains and related subsystems, materials handling, supports, ductwork, insulations, electrical, instrumentation and controls including:
 - (a) Motor control center, control room, instrumentation, telephone and intercom,
 - (b) HVAC and lighting;
 - (c) Fire alarm and sprinkler systems;
 - (d) Safety equipment and materials;
- (2) Odor and Air Emission Controls System (“OCS”) as detailed in Appendix 3.
- (3) Finished Product Storage and Distribution System including:
 - (a) three (3) product silos adjacent to the TDF and situated on frame supports forming a covered area for loading trucks;
 - (b) a pellet coating oil storage and supply system;
 - (c) nitrogen storage and supply system.

Location of the new buildings and structures is depicted on the Drawings in Appendix 5.

2.6 Utilities

2.6.1 New Utilities and Subsystems. The following new utilities and subsystems shall be included, but may not be limited to:

- (A) New electrical substation connection;
- (B) Natural and digester gas connections;
- (C) Potable water connection.

2.6.2 Potable Water

(A) Potable water for process purposes will be supplied from the 12” water main located in front of the BRC. The process potable water to the TDF is provided through a new 10” line connected to the existing 12” City water main located on Penrose Ferry Road. Potable water for TDF fire suppression services will be provided through a new 8” line connected to the existing 10” hydrant system.

FINAL

(B) Potable water will be required for the following uses and in the following estimated amounts:

- (1) Operation of the TDF: The TDF will require a flow rate up to 2,200 GPM at the peak water demand;
- (2) Odor Control Scrubber: The new Odor Control Scrubber (OCS), to be located adjacent to the Dewatering Building, will require approximately 20 GPM;
- (3) Washdowns: Washdowns in the TDF and other areas will require an estimated 20 GPM during washdown periods;
- (4) Fire Protection: activation of Fire Protection flows will shut down operational plant flows;
- (5) Staff uses and miscellaneous consumption: 20 GPM.

(C) The City shall deliver the required amount of potable water at no charge to the Company during the Interim and the Class A Periods.

(D) Potable water for process purposes shall be metered by the Company. It is assumed that the existing 10" backflow preventer can be reused and maintained by the Company.

2.6.3 Plant Water. The Dewatering Facility will continue to be supplied with plant water from the existing connections.

2.7 Design and Construction Standards

Except where the Design Requirements include more stringent requirements, the Company shall design the Class A Facilities and the Improvements to the Existing Facilities in accordance with the applicable codes standards and regulations set forth in this section. If any codes and standards are duplicative or conflicting, the Company will determine the proper code/standard necessary to meet the Design Requirements and Performance Standards and Guarantees. All design drawings shall be stamped by a qualified engineer duly licensed by the Commonwealth of Pennsylvania. All design personnel shall perform their work in conformance with all applicable laws and regulations and shall be qualified for the design worked being performed.

2.7.1 National, State, and Local Codes and Standards

- American Association of State Highway and Transportation Officials (AASHTO)
- American Concrete Institute (ACI)
- American Institute of Steel Construction (AISC)
- American Boiler Manufacturer's Association (ABMA)
- American National Standards Institute (ANSI)
- American Society of Mechanical Engineers (ASME)
- American Society for Testing and Materials (ASTM)

- American Society of Heating, Refrigeration, and Air Conditioning Engineers (ASHRAE)
- American Welding Society (AWS)
- Illuminating Engineers Society (IES)
- Instrument Society of America (ISA)
- Sheet Metal and Air Conditioning National Company's Association (SMACNA)
- International Standards Organizations (ISO)
- National Board of Fire Underwriters (NBFU)
- National Electric Code (NEC)
- National Fire Protection Association (NFPA)
- National Electrical Manufacturer's Association (NEMA)
- National Electrical Safety Code (NESC)
- Occupational Safety and Health Administration (OSHA)
- Steel Structures Painting Council (SSPC)
- Underwriters Laboratories (UL)
- American Gear Manufacturer's Association (AGMA)
- National Roofing Companies' Association (NRCA)
- American Society of Civil Engineers (ASCE)
- American Water Works Association (AWWA)
- Conveyor Equipment Manufacturer's Association (CEMA)
- Pre-stressed Concrete Institute (PCI)
- American with Disabilities Act (ADA), as applicable

2.7.2 Applicable Law and Standards. The following state and local standards are included in Applicable Law:

- PA – Department of Environmental Protection (PA DEP)– Design Guidance Manual for Wastewater Facilities
- PA – Department of Transportation (PENNDOT) Standards
- Philadelphia Water Department – Standard Details for Sewers
- City of Philadelphia – Codes for Building, Plumbing and Electrical
- City of Philadelphia – Department of Health - Demolition Standards
- City of Philadelphia - Air Management Services – Asbestos Control Regulations
- City of Philadelphia – Zoning Ordinance
- City of Philadelphia Department of Streets – Standard Construction Items and Specifications
- City of Philadelphia – Noise Ordinance

2.8 Facility Design Specifications, Drawings, Product Data and Samples

Before initiation of the Design Work, the Company shall prepare and submit to City a

FINAL

comprehensive submittal register and schedule regarding the availability of design specifications, drawings, product data and samples that will be submitted to City for its review. City may review and comment on such drawings, specifications, data and samples but shall have no authority or responsibility relative to the approval, appropriateness or accuracy of such design submittals, provided that if City comments indicate that any requirement of this Service Agreement is not being met, then the Company shall make the necessary correction in accordance with the terms of the Service Agreement. In any event, the Company shall verify the accuracy and appropriateness of such drawings, data, samples, field measurements and field construction criteria. Any such City review will be completed within two weeks and the City will have no responsibility for the accuracy or appropriateness of such drawings, specifications, data, samples, field measurements and criteria.

2.9 Construction Work

The Construction Work shall be performed in accordance with the design documents reviewed by City. The Company shall provide qualified personnel to supervise and oversee the Construction Work. The Company shall be solely responsible for all construction, fabrication, delivery, erection, installation, tests, means, methods, techniques, sequences, safety, and procedures.

2.10 Site Security

During its performance of the Construction Work and at all other times, the Company shall be responsible for security of the Leased Premises.

2.11 Labor and Materials

The Company shall provide and pay for all labor, materials, equipment, tools, construction equipment and machinery, transportation and other facilities and services necessary for the proper execution and completion of the Construction Work. The Company shall at all times enforce discipline and good order among all personnel involved in the Construction Work, including Company and subcontractor employees, and shall not employ (or allow any subcontractor to employ) any unfit person or anyone not skilled in the task assigned them.

2.12 Construction Quality Assurance/Quality Control Plan

(A) The Company shall submit to the City a construction quality assurance/quality control plan ("Construction QA/QC Plan") not later than 90 days before starting any Construction Work. Any comments or questions provided by the City within 30 days shall be addressed by the Company to the City's reasonable satisfaction. The Construction QA/QC Plan shall establish a protocol to maintain an effective construction quality control system. Such plan shall identify the personnel, their qualifications, inspection procedures, sampling and test procedures, frequency and number of tests, laboratory and field test standards, and materials requiring testing that will be used to ensure that the completed Construction Work complies with the final design and

specifications. The Construction QA/QC Plan shall address all construction and manufacturing operations, both at and away from the construction sites, and shall be keyed to the proposed construction sequence. The City shall be notified in advance of all testing and may attend shop and other tests related to the construction elements.

(B) All testing and inspection, whether required by Applicable Law, or whether performed by Company for quality control, shall be at Company’s expense. The Company shall procure and pay for the services of an independent testing and inspection agency registered in the Commonwealth of Pennsylvania.

2.13 Documents and Samples at the Site

The Company shall maintain at the site, on a current basis, one record copy of all drawings, specifications, submittals, samples, product data, addenda, change orders, modifications and other documents related to the Construction Work marked currently to record all changes made during construction. These shall be available to the City and shall be delivered to the City upon completion of the work. The Company shall advise the City on a current basis of all changes in the Construction Work made during construction.

2.14 Construction Progress Meetings

Construction progress meetings shall be held at least monthly throughout the construction phase and may be combined with monthly operations meetings, as appropriate. Topics covered should include actual vs. scheduled progress; schedule revisions; planned construction activities; fabrication and delivery schedules; measures to regain projected schedule; submittal schedules; field observations, problems and conflicts; quality control; actual and potential changes; and safety issues.

2.15 Equipment List – Table 2-1

Subject to completion of the final design work, the following is a list of the Facility Equipment and Structures that are to be built by the Company.

Table 2-1

Preliminary Equipment List

	MAJOR EQUIPMENT ITEM	QTY	TYPE DESCRIPTION
Sludge Dewatering Scrubber			
	PROCESS EQUIPMENT		

	Odor control scrubber	1	Two Stage
	Recirculating pumps	2	
	Sump pumps	2	
	Exhaust Fan	1	
	caustic storage tank	2	10,000 gal. FRP storage tank
	Hypo storage tank	2	10,000 gal. FRP storage tank
	Acid storage tank	1	500 gal. FPR
	Caustic metering pump	2	
	Hypo metering pump	2	
	Acid metering pump	1	
Thermal Drying Facility			
	PROCESS EQUIPMENT		
	24" Primary transfer screw conveyor	2	Shaftless screw conveyor from belt conveyor
	24" secondary transfer conveyor	2	Shaftless screw conveyor from primary transfer conveyor to second dryer with partial stainless cladding
	Furnace	2	Furnace with gas trains and blower
	Dryer drum	2	carbon steel
	Preseparator	2	AR steel
	Induced draft fan	2	carbon steel
	Rotary valve	2	cast iron
	Polycyclone screw conveyor	2	carbon steel with UHMW liner
	Rotary valve	2	cast iron
	Vibrating screen	2	carbon steel
	Crusher	2	
	Recycle feed screw conveyor	2	carbon steel with UHMW liner
	Recycle feed bucket elevator	2	316 s steel
	Recycle bin	2	s. steel with bin activator & slide gate
	Recycle dosing screw conveyor	2	carbon steel with UHMW liner
	Wet material bin	2	carbon steel with UHMW liner
	Wet material dosing screw conveyor	2	carbon steel with UHMW liner
	Mixer feed pump	2	
	Mixer	2	carbon steel w/ wear liner
	Final product bucket elevator	2	316 s steel
	Final product screw conveyor	2	
	Pellet cooler	2	316 s. steel
	Pneumatic conveyor	2	carbon steel

	Air compressor	2	with carbon steel receiver and dryer
	Saturator	2	s. steel
	Saturator pump	2	
	Venturi	2	s. steel
	Venturi blower	2	s. steel
	Regenerative thermal oxidizer	2	
Sludge Pellet Unloading Facility			
	PROCESS EQUIPMENT		
	Final product storage silo	3	with bin activator & slide gate
	loadout Chute	1	Air cones
	Silo outloading conveyors	3	
	Final product blender	1	
	Main Dust Process Collector	2	carbon steel fan
	Silo area dust collector	1	carbon steel fan
	Rotary Airlock	2	cast iron
	Silo Dust Collector Airlock	1	cast iron
	Nitrogen System	1	
	Pellet Coating System	1	

Appendix 3

Odor and Air Emission Control

3.1 Odor and Air Emission Control General Requirements

The Company will implement the following odor and air emission control procedures and improvements to reduce odors and air emissions and shall meet all requirements of Applicable Law.

3.2 Interim Period Odor and Air Emission Control

(A) The Company shall not compost Dewatered City Biosolids. 100% of the Dewatered City Biosolids shall be utilized in land application or disposed of in a landfill. Company shall remove all existing composting materials from the BRC Site during the Interim Period in accordance with the Service Agreement.

(B) The Company shall use odor control agents and specific operational practices for Class B Product and other Dewatered City Biosolids odor control during the Interim Period as necessary to comply with all permits and Applicable Law.

3.3 Class A Period Odor and Air Emission Control

3.3.1 Design of Class A Period Odor and Air Emission Control

(A) The Company shall design, procure, construct, test, startup, and operate a new Odor Control Scrubber (OCS) to control odorous emissions from the Dewatering Facility, Truck Loadout Bay, and Thermal Drying Facility.

(B) The Company shall design, procure, construct test, and startup a new Thermal Drying Facility (TDF) to reduce biosolids volume and produce dried pellets while using Best Available Control Technology (BACT) for odor and air emission control.

3.3.2 Odor Control Scrubbing System

(A) The OCS will control odors at the following sources:

- (1) Dewatering Facility including liquid biosolids storage tanks;
- (2) Modified Truck Loading Bay (TLB)
- (3) New Thermal Drying Facility and Process

(B) Odorous air will be contained and ventilated to the OCS from the following areas:

- (1) Headspace on the liquid sludge storage tanks in the Dewatering Building (to collect the volume of air displaced by sludge pumping)

FINAL VERSION

- (2) Centrifuge cake and centrate discharge chutes
- (3) Cake conveyor floor of the Dewatering Facility
- (4) Cake Truck Loading Bays
- (5) Cake conveyors to the Thermal Drying Facility
- (6) Cake conveyors inside the Thermal Drying Facility
- (7) Exhaust air from the fabric filters of the Andritz Drying Train
- (8) Cake receiving bins inside the Thermal Dryer Facility
- (9) Ambient air ventilated from the Thermal Drying Facility will be used as makeup air to the conveyor floor of the Dewatering Facility. Ambient air from the Thermal Drying Facility will also be ventilated through the modified Truck Loading Bay and the extended conveyor room. These air flows will be directed to the OCS for treatment.
- (10) All fugitive dust baghouses (including those at the pellet silos) in the new Thermal Drying Facility will be vented to the OCS.

(C) The ventilation air inside the Thermal Drying Facility is generally not considered odorous. It will be collected and used as makeup air to other spaces and then vented to the OCS. This air reuse approach will serve two purposes. First, this allows further assurance that the low-level odors from the Thermal Drying Facility are collected and treated before release. Secondly, this allows for a more energy efficient system that reuses this already preheated air as makeup air for the Truck Loading Bay and the conveyor floor of the Dewatering Facility. Approximately 37,500 Cubic Feet per Minute (CFM) of the ambient air from the Thermal Drying Facility will be used as makeup air to ventilate the conveyor floor of the Dewatering Facility and the Truck Loading Bay. This makeup air will then be vented directly to the OCS.

(D) Table 3.1 summarizes the odorous air ventilation rates.

Table 3.1 Ventilation Rate by Odor Source (Preliminary)

Source	No. Of Units	Each Unit CFM	Total Ventilation, CFM
Sludge Storage Tanks	3	733	2,200
Centrifuge Cake Chute	10	200	2,000
Centrifuge Centrate Chute	10	200	2,000
Belt Conveyors @ Dewatering (2 nd floor)	Lot		24,000 @ 12 ACH
Truck Loadout Bay	Lot		9,500 @ 20 ACH
Cake Conveyance to TDF	Lot		1200
Centrate Tanks	Lot		300
Dust Bag House Exhaust	3	2@2,500 1@2,000	7,000

Wet Cake Bins @ TDF	2	1,800	3,600
Total			51,800

(E) The planned OCS is characterized as follows:

Flow	51,800 acfm
Manufacturer	DuAll, or equal
Removal Efficiency	99% of H ₂ S or better 99% of NH ₃

(F) The OCS Process Flow Diagram is depicted on Drawing M-001, Appendix 5. The Air Flow Diagram is depicted on Drawing H-501, Appendix 5.

(G) The normal operating mode will use caustic/hypochlorite chemistry for absorption and oxidation of H₂S odors. However, flexibility is provided to allow for an acid first stage should ammonia or amine based odors prove to be an issue. The treated exhaust is also discharged through a tall exhaust stack that will promote additional dilution of the exhaust through dispersion. The elevation of the exhaust stack is to be approximately 20 feet above the roadway elevation of the Platt Bridge, which is at the same approximate elevation as the roof of the Dewatering Facility. Final stack height is subject to regulatory approval and limits, and cost of final stack is Company's responsibility.

3.3.3 Andritz Drying System

(A) The major design features of the Andritz Drying system with regards to air emission and odor control are as follows:

- (1) High rate exhaust gas recirculation (up to 85%);
- (2) State-of-the-art multi-step exhaust gas treatment comprising high efficiency polycyclones, impingement tray scrubber, condenser/sub-cooler, multiple venturis and three chamber Regenerative Thermal Oxidizer (RTO) to remove particulate matter and odorous gaseous components;
- (3) Enclosed and ventilated processing and material handling equipment with exhaust treated by Best Available Control Technology (BACT);
- (4) Fabric filters to control fugitive emission from dry material equipment and storage silos; and
- (5) Oil coating to improve product quality, reduce potential product odor and dust during transportation.

(B) The Andritz system exhaust gas will pass through several stages of odor destruction prior to its discharge to the atmosphere. Air will enter the drying process at the dryer combustion furnace and will be heated in the furnace by natural gas, Digester

Gas and/or Alternative Fuel. The heated air will be discharged into the dryer where it will be mixed with the evaporated water vapor within the sealed dryer drum. From the drum, process air is discharged into the air/solids separator where odor containing exhaust gas is separated from the dried pellets. The pellets exit the bottom of the separator and process air exits the top of the separator into the air emissions/odor control equipment.

(C) The first air emissions/odor/dust control device encountered by the exhaust gas after the air/solids separator is the set of high efficiency polycyclones followed by the impingement tray condenser/sub-cooler. Here, the exhaust gas is sprayed with water with a high liquid-to-gas ratio. The primary purposes of the impingement tray condenser/sub-cooler are: (a) to remove particulate matter left in the exhaust gas after polycyclones, and (b) to cool process air to facilitate condensation of water vapor and condensable VOCs.

(D) After the impingement tray condenser/sub-cooler, the cooled and cleaned exhaust gas is divided into two streams: (a) up to 85% of the total flow is recycled back to the dryer furnace; and (b) the remaining exhaust gas flow (15%) is transported to a venturi-scrubber. In the venturi-pak, the exhaust gas is routed through a set of venturis to agglomerate and remove submicron particles. Again the exhaust gas will be sprayed with water on a "once-through" basis with a high liquid-to-gas ratio. At this point, the exhaust gas is further cooled and the majority of the condensable pollutants, including the VOCs, are dissolved into the liquid discharge. This results in extremely high odor absorption and heat transfer efficiency.

(E) Process air recycled back to the inlet of the dryer furnace is again subjected to the same clean up processes. Exhaust gas is routed to the three-chamber RTO.

(F) Air vented from the Andritz dewatered biosolids cake bins and from the wet biosolids conveyance will be treated by the OCS as previously described in this section.

(G) All process equipment handling dried biosolids (screen, crusher, bucket elevators, pneumatic transfer system, etc.) will be enclosed, dust-tight, and vented to fugitive dust collectors (fabric filters) for dust removal. The fabric filter exhaust will be routed to the OCS. The pellet storage silos and the silo load-out telescopic spout will also be equipped with fabric filters and the exhaust will be routed through the OCS for deodorization prior to its discharge to the atmosphere.

3.4 Class A Period Odor and Air Emissions Control Operations

3.4.1 Operational Procedures

(A) To ensure that the Class A Facilities are operating within the constraints of the applicable laws, operating permits and contract requirements, the Company will rely on a

detailed, written operation and maintenance program for the odor and air emission control equipment (OAECE). This O&M program will be documented in the O&M Manual that will be prepared for the Class A Facilities. The program will be implemented using the computer-based management system. This program will be used to schedule the routine maintenance of the OAECE and to document that it has been completed to the satisfaction of manufacturer's recommendations and/or the Company's requirements.

(B) Operational control panels and measurement instrumentation on the OAECE train will be monitored to ensure that they are fully functional at all times. Appropriate operational information will be recorded by automatic devices to ensure that data is collected to document the performance of the OAECE. All control equipment will be observed by the appropriate shift according to a set schedule to ensure the proper function of the OAECE train to document that it is operating accurately. The control and recording equipment will also be maintained according to the maintenance schedule specified in the O&M Manual and the maintenance software program.

(C) The collection of OAECE equipment operations data combined with routine maintenance of both the actual OAECE equipment and its associated measurement and recording devices will form the basis of the demonstration to the City and environmental agencies having jurisdiction, that the OAECE train is functioning properly and according to permit requirements and design specifications.

3.5 Class A Period Separate Air Permit

The Company will apply for a separate Facility Air Permit (not combined with the SWWPCP) for the Class A Period. The Class A Facilities combined with the dewatering operation of the Existing Facilities are designed to emit VOCs and NO_x at a rate of less than twenty-five (25) Tons per year each (the regulatory threshold to be considered a Major Stationary Source) The Class A Facilities will be designed to comply with all applicable air regulations and permits. The Company will conduct odor and air emission control system testing as required by environmental regulations and permits.

Appendix 4
Project Schedule

PHILADELPHIA BIOSOLIDS SERVICES, LLC
Thermal Dryer Building
Preliminary Design-Build Schedule

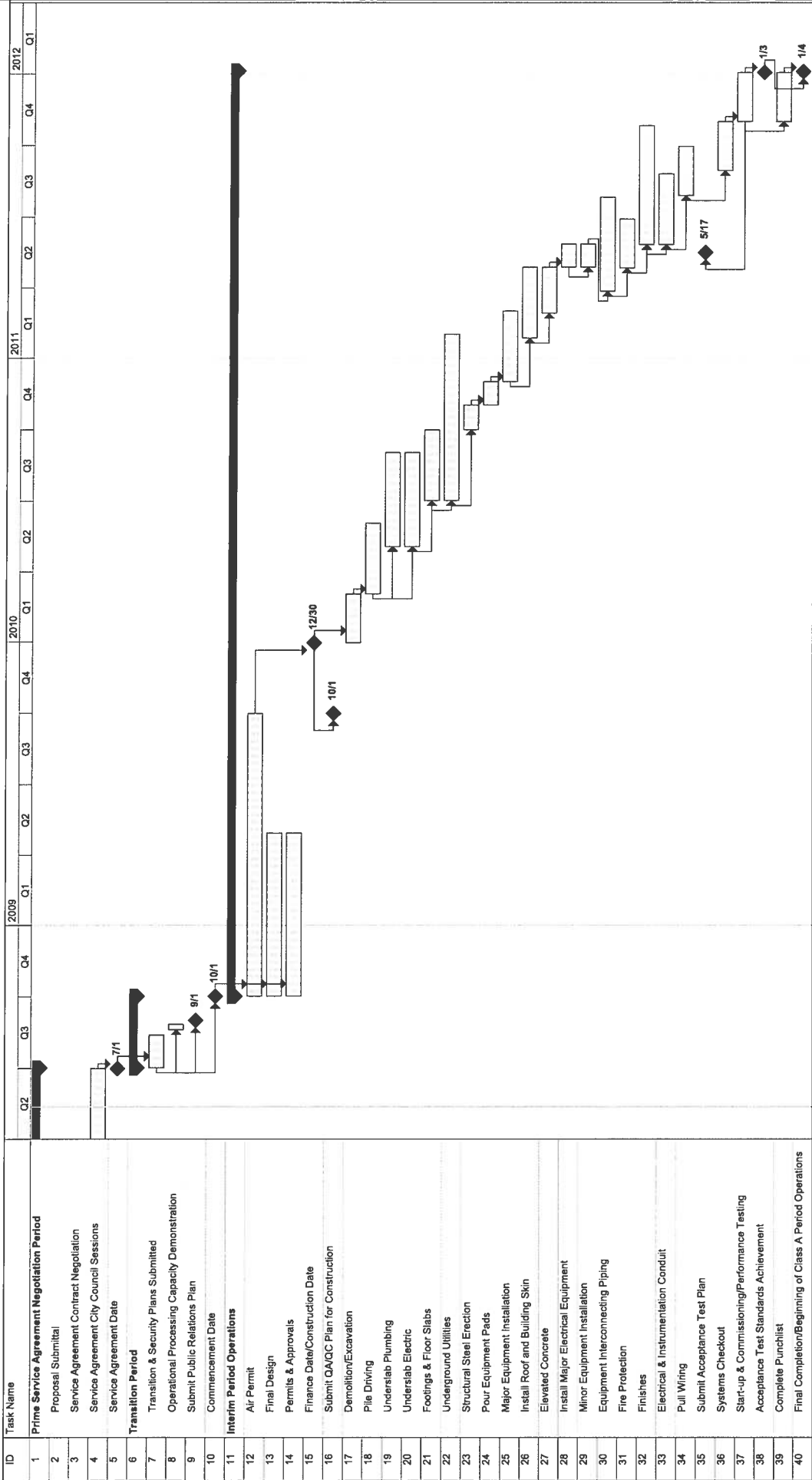

Legend:

- Task: [Bar]
- Split: [Bar]
- Progress: [Bar]
- Milestone: [Diamond]
- Summary: [Bar]
- Project Summary: [Bar]
- External Tasks: [Bar]
- External Milestone: [Diamond]
- Deadline: [Arrow]

Project: Preliminary PHL BRC
Date: Mon 5/1/2008

Appendix 5

Project Plans and Specifications

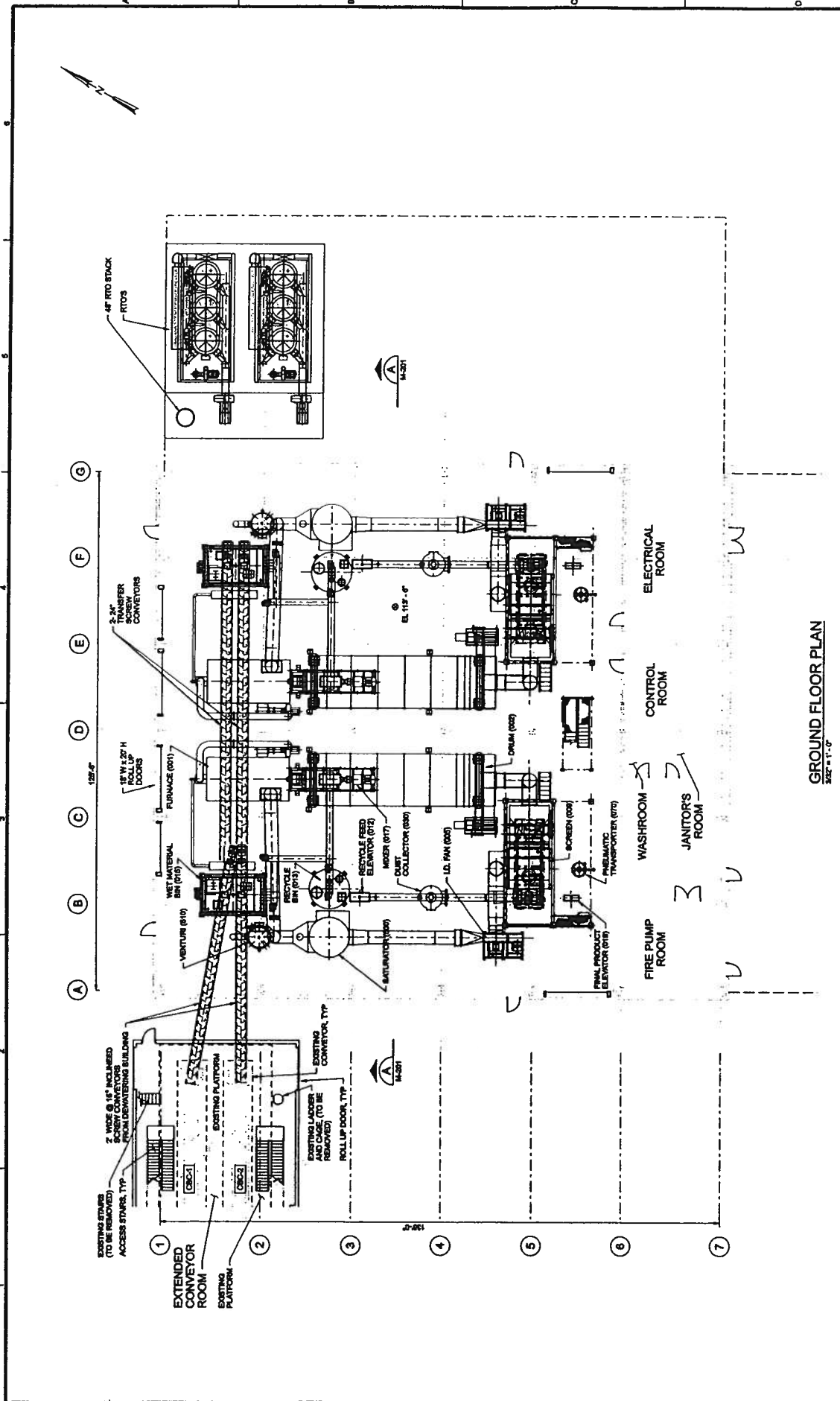

NOT FOR CONSTRUCTION		REVISION		DATE		BY	
NO.	DATE	BY	DATE	NO.	DATE	BY	DATE
2	04 / 2004			1	04 / 2004		
1	04 / 2004						
0	04 / 2004						
PHILADELPHIA WATER DEPARTMENT CONTRACT OPERATIONS OF THE BIOSOLIDS RECYCLING CENTER				CH2MHILL			
THERMAL DRYING FACILITY MECHANICAL PLAN				Project: 04-00141_202784.dwg			
DWG: 04-04-141		DATE: 04-04-141		PROJ: 202784		SHEET: 04-04-141	

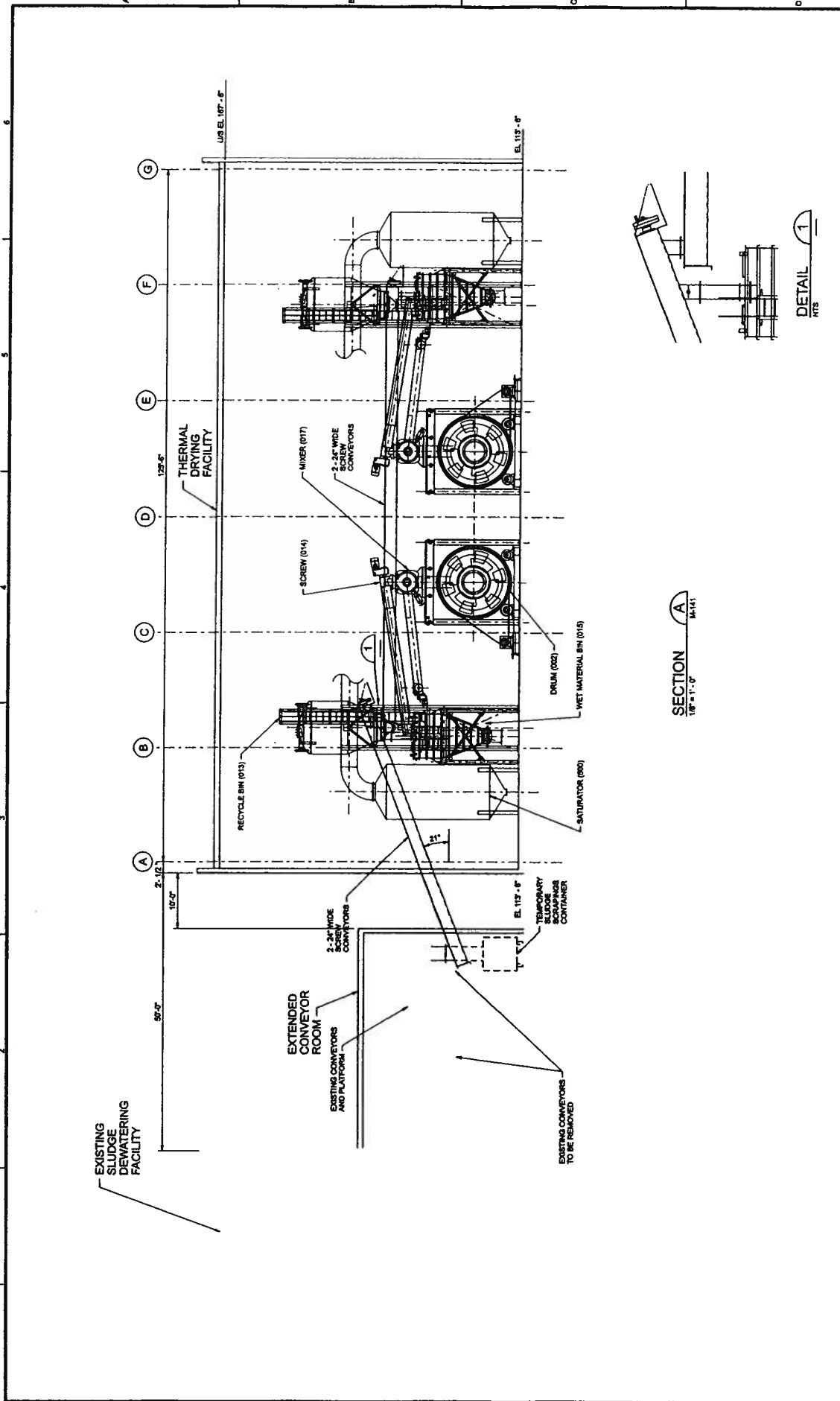

SECTION
1/8" = 1'-0"
A
M-141

DETAIL
1
M-141

NOT FOR CONSTRUCTION	ISSUE NO.	2	24 / 2005	ISSUED FOR PROPOSAL	BY: JAP/D	DATE	REVISION	PHILADELPHIA WATER DEPARTMENT CONTRACT OPERATIONS OF THE BIOSOLIDS RECYCLING CENTER	THERMAL DRYING FACILITY MECHANICAL SECTION	DWG. NO. 40-40-001
	DATE	11 / 2004	ISSUED FOR PROPOSAL	DATE						
PROJECT NO.	40-40-001	222788.dgn	PROJECT	24-UTR-2005						

PROPOSAL

REUSE OF DOCUMENTS:
THIS DOCUMENT AND THE IDEAS AND DESIGNS INCORPORATED HEREIN MAY BE REPRODUCED OR TRANSMITTED IN ANY FORM OR BY ANY MEANS, ELECTRONIC OR MECHANICAL, INCLUDING PHOTOCOPYING, RECORDING, OR BY ANY INFORMATION STORAGE AND RETRIEVAL SYSTEM, WITHOUT THE WRITTEN PERMISSION OF CH2M HILL.

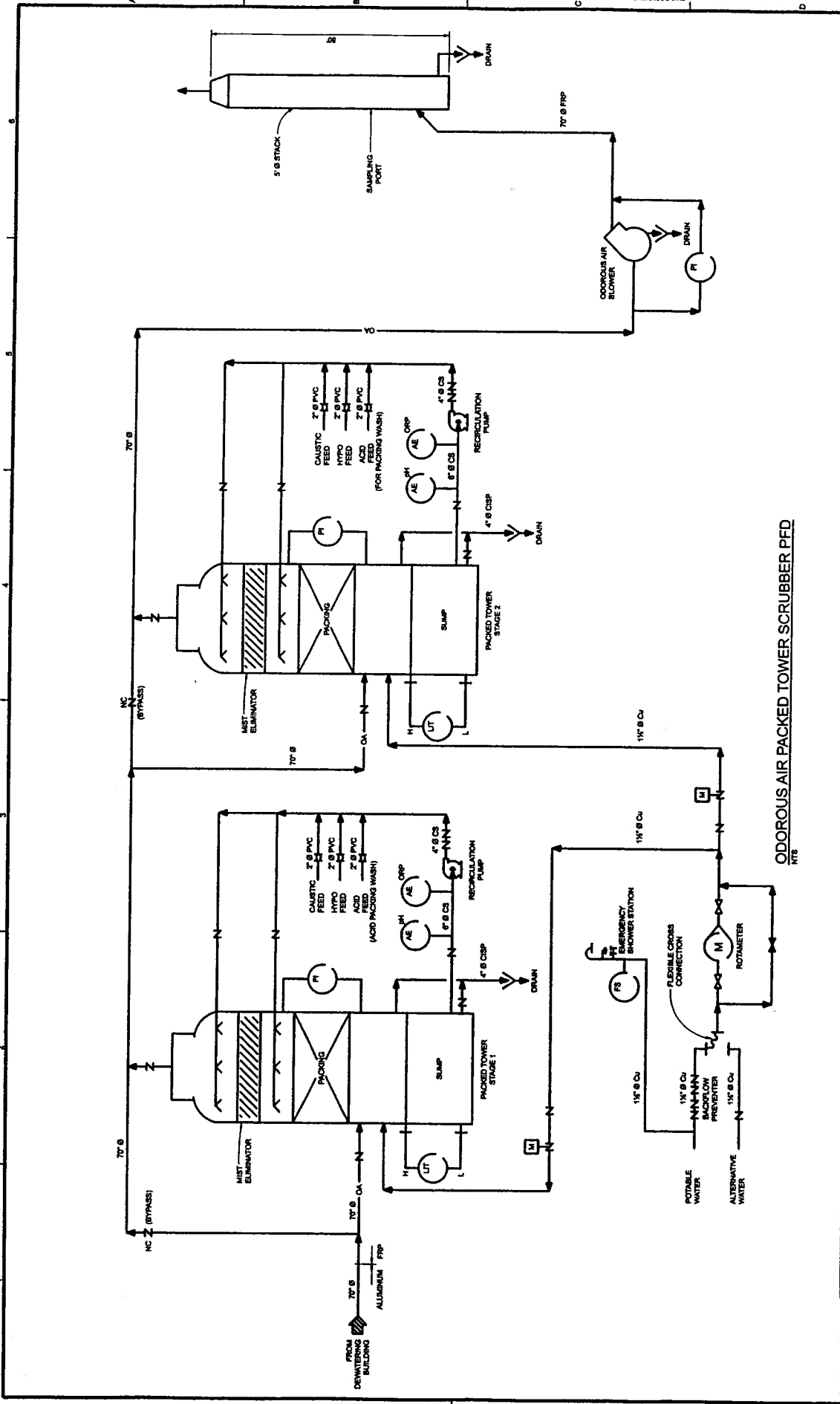

ODOROUS AIR PACKED TOWER SCRUBBER PFD

NOT FOR CONSTRUCTION

DESIGN	BY	DATE	REVISION
DR			
CHK			
APP			

VERIFY SCALE
 1" = 10' (VERTICAL)
 1" = 10' (HORIZONTAL)
 ALL DIMENSIONS UNLESS OTHERWISE SPECIFIED

PHILADELPHIA WATER DEPARTMENT
 CONTRACT OPERATIONS OF THE
 BIOSOLIDS RECYCLING CENTER

CH2MHILL

GENERAL
 ODOROUS AIR SCRUBBER SYSTEM
 PROCESS FLOW DIAGRAM

DWG. NO. M-001
 DATE: AUGUST 2004
 PROJ. 282788

ISSUED: 08/04/04

THIS DOCUMENT AND THE DATA AND DESIGNS INCORPORATED HEREIN ARE THE PROPERTY OF CH2MHILL AND ARE NOT TO BE USED, IN WHOLE OR IN PART, FOR ANY OTHER PROJECT WITHOUT THE WRITTEN AUTHORIZATION OF CH2MHILL.

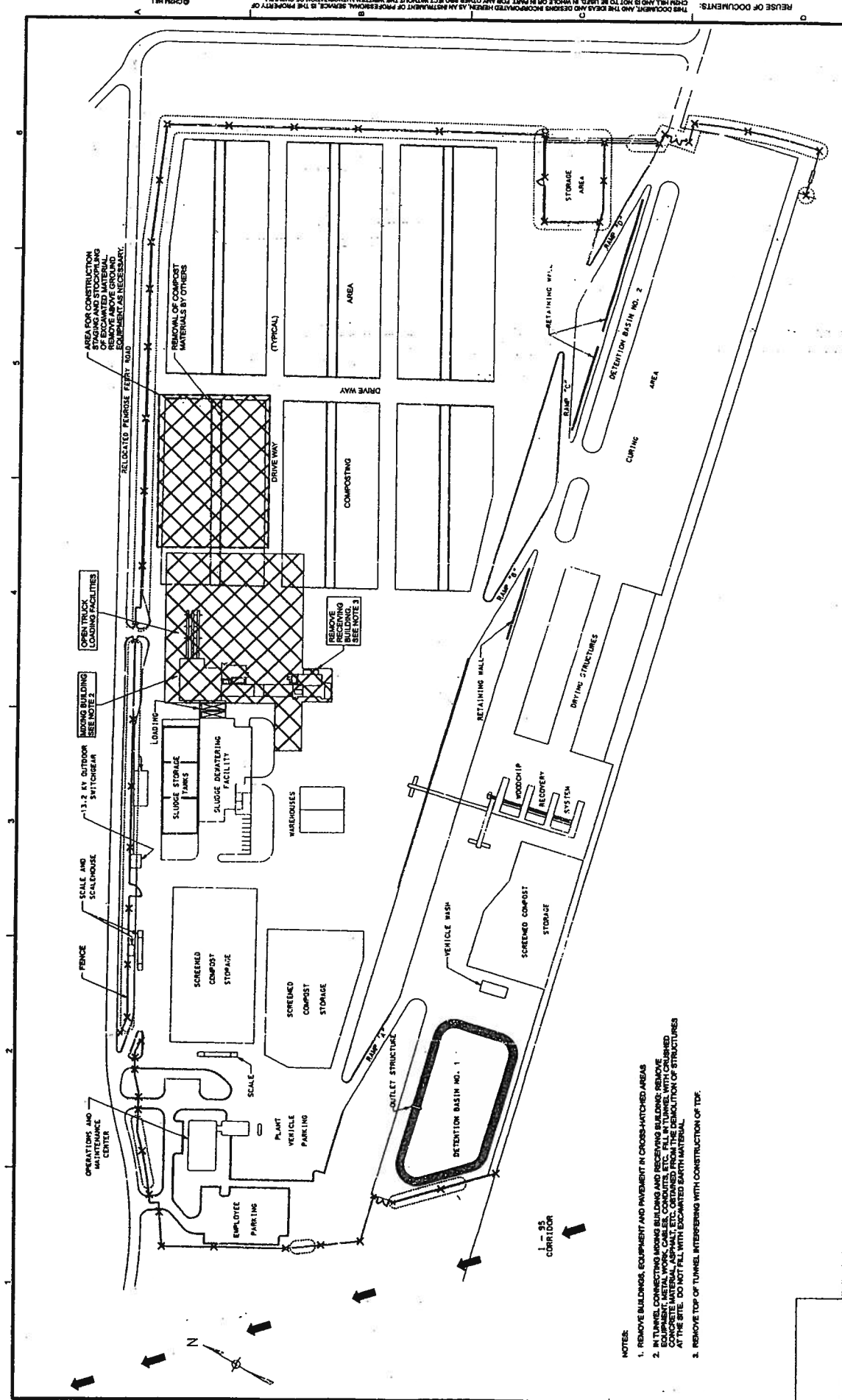

- NOTES:
1. REMOVE BUILDINGS, EQUIPMENT AND PAVEMENT IN CROSS-HATCHED AREAS
 2. IN TUNNEL CONNECTING WORKING BUILDINGS AND RECEIVING BUILDINGS, REMOVE EQUIPMENT, METAL WORK, CABLES, CONDUITS, ETC. FILL IN TUNNEL WITH CRUSHED CONCRETE, METAL, BRICK, ETC. OBTAINED FROM THE DEMOLITION OF STRUCTURES AT THE SITE. DO NOT FILL WITH EXCAVATED EARTH MATERIAL.
 3. REMOVE TOP OF TUNNEL INTERFERING WITH CONSTRUCTION OF TDR.

NOT FOR CONSTRUCTION	ISSUED FOR PROPOSAL	DATE	1 MAY 2005	PHILADELPHIA WATER DEPARTMENT CONTRACT OPERATIONS OF THE BIOSOLIDS RECYCLING CENTER	SITE CIVIL REMOVALS PLAN	DWG	C-100
	ISSUED FOR PROPOSAL	DATE	1 MAY 2005			PROJ	2827318
BY	JAVD	BY	JAVD	SCALE	AS SHOWN	PROJECT	02-REC-2005

THIS DOCUMENT AND THE IDEAS AND DESIGNS INCORPORATED HEREIN ARE THE PROPERTY OF CH2M HILL AND IS NOT TO BE USED, IN WHOLE OR IN PART, FOR ANY OTHER PROJECT WITHOUT THE WRITTEN AUTHORIZATION OF CH2M HILL.

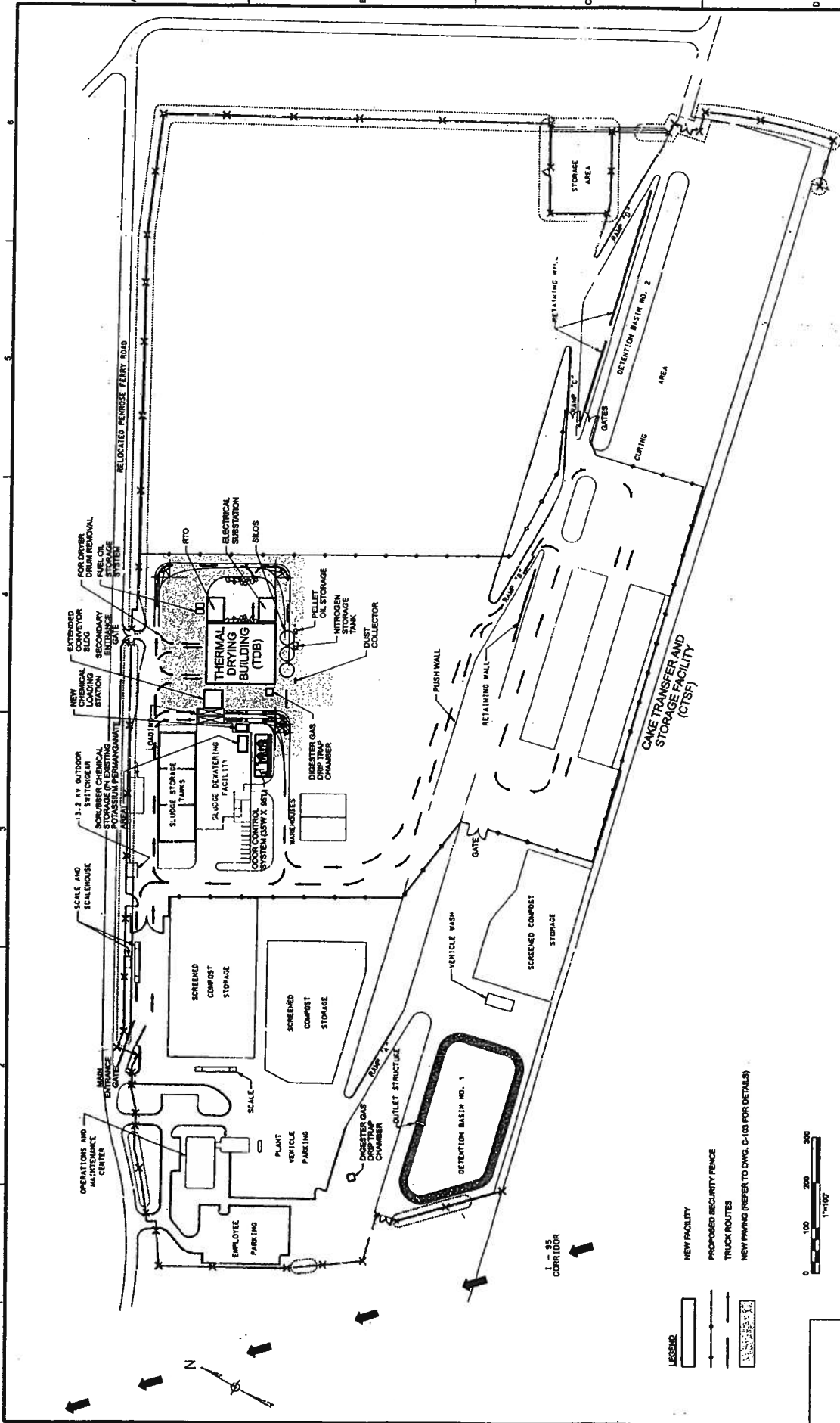

NOT FOR CONSTRUCTION DESIGNED BY: J. P. BISHOP CHECKED BY: P. WOODS DATE: 1 MAY 2005		ISSUED FOR PROPOSAL REVIEWED BY: J. P. BISHOP DATE: 1 MAY 2005		VERIFY SCALE BAR IS ONE INCH ON DRAWING AND ONE FOOT ON PLOT ONE WITH ONE INCH EQUAL TO ONE HUNDRED FEET UNLESS OTHERWISE NOTED		CH2MHILL		PHILADELPHIA WATER DEPARTMENT CONTRACT OPERATIONS OF THE BIOSOLIDS RECYCLING CENTER		SITE CIVIL SITE PLAN		DWG: C-103 DATE: MAY 2005 PROJ: 282783 SHEET: 02-DEC-2005	
---	--	--	--	--	--	-----------------	--	---	--	-------------------------	--	--	--

THIS DOCUMENT AND THE REVISIONS INCORPORATED HEREIN AS AN INSTRUMENT OF PROFESSIONAL SERVICE IS THE PROPERTY OF CH2M HILL AND IS NOT TO BE USED, IN WHOLE OR IN PART, FOR ANY OTHER PROJECT WITHOUT THE WRITTEN AUTHORIZATION OF CH2M HILL.

Appendix 6

Acceptance Test Standards

6.0 City/PMA Obligations or Actions

Where PMA is required under the Service Agreement to cause the City to take any action or to undertake any responsibility, those acts or responsibilities will be referred to in this Appendix as acts and responsibilities of the “City.” Where the City has undertaken any obligation under the Service Contract, those obligations are also referred to in this Appendix as “City” obligations. Where PMA has authorized the City to receive, review or approve Company submittals these will be referred to in this Appendix as the “City” receipt, review or approval.

6.1 Acceptance Test Standards

(A) When tested in accordance with the Acceptance Test Procedures contained in Section 6.2 of this Appendix 6 and the Acceptance Test Plan developed in accordance with Section 6.12 of the Service Agreement, the Class A Facilities shall be capable of simultaneously meeting all of the following Acceptance Test Standards:

- (1) The Class A Facilities shall be capable of processing a minimum of 225 Dry Tons per 24 hour period of City Dewatered Biosolids.
- (2) The Class A Product produced by the Class A Facilities shall:
 - (a) At least meet the requirements of
 - (i) EPA Part 503 regulations for Class A pathogen reduction standards;
 - (ii) EPA Part 503 regulations for Class A vector attraction reduction standards.
 - (b) Have the minimum physical characteristics of ninety (90) percent solids.
- (3) During a 12-hour period during the five-day Acceptance Test period Company shall measure gas and electric consumption to demonstrate:
 - (a) gas consumption at or below 85 Therms per Dry Ton, and
 - (b) electric consumption at or below 375 Kilowatt hours per Dry Ton;
 - (c) However, if Company, during the 12 hour test period, does not exceed 90 Therms per Dry Ton or 400 Kilowatt hours per Dry Ton, the Class A Facilities shall be deemed to have met the requirements of Section 6.(A)(3).
- (4) The Class A Facilities shall be in compliance with the provisions of Applicable Law including the conditions and requirements of all Governmental Approvals.

6.2 Acceptance Test Procedures

- (A) Purpose. The purpose of this section of Appendix 6 is to provide an outline of the procedures for Acceptance Tests to be incorporated in the Acceptance Test Plan to be developed by the Company pursuant to Section 6.12 of the Service Agreement.
- (B) Duration and Nature of Acceptance Tests. Company and City shall take all reasonable steps to insure that acceptable quantities of Conforming City Biosolids are available for the Acceptance Tests. Conditioned upon receipt of appropriate amounts of Conforming City Biosolids, the Class A Facility must be operated for five (5) days of continuous operation of both trains to demonstrate capability not less than the processing capacity specified in Section 6.1(A)(1) of Appendix 6. Utilities utilized shall be recorded to determine compliance with the requirements of Sections 6.1(A) (3) of Appendix 6. The Class A Facility shall produce a Class A Product meeting the requirements of Section 6.1(A)(2) of Appendix 6.
- (C) Operation During Acceptance Tests
- (1) During Acceptance Testing, normal operating personnel shall operate the Class A Facilities in accordance with normal operating and maintenance procedures and staffing levels (except that special staffing required to conduct the tests and record measurements will be acceptable), and shall perform all routine functions of operation and maintenance.
 - (2) Shutdown of all or a part of the Class A Facilities to make necessary repairs to equipment or to correct normal operational problems will be permitted, provided that the duration of some tests may need to be extended or the tests repeated.
- (D) Acceptance Test Plan. The Acceptance Test plan developed pursuant to Section 6.12 of the Service Agreement and this Appendix shall, for each test required to demonstrate each of the Acceptance Test Standards, include at a minimum:
- (1) The detailed test protocols to be used;
 - (2) A listing of the parameters to be measured;
 - (3) The method of measurement and recording of the data;
 - (4) The frequency with which each datum will be recorded; the meters and other instrumentation to be used and the physical location of such meters and instruments;
 - (5) The details of corrections to be performed;
 - (6) Copies of any manufacturers correction curves that will be used to perform such corrections;
 - (7) Sample calculations; and
 - (8) A detailed test schedule.
- (E) Instrumentation and Calibration. Instrumentation employed during Acceptance Testing shall consist primarily of the permanent instrumentation supplied by the Company supplemented, if necessary, by temporary, portable, or laboratory devices. All instrumentation to be relied upon during Acceptance Testing shall be calibrated, in accordance with applicable ASTM, EPA or

FINAL VERSION

other recognized procedures, by an independent party. Instrumentation that is sent to outside laboratories for certification shall be calibrated within 60 days of the commencement of the Acceptance Tests. Instrumentation that is calibrated in situ, shall be calibrated within 30 days of the commencement of the Acceptance Tests. The Company shall furnish documentation confirming the calibration of such instruments prior to the commencement of the Acceptance Tests.

(F) Sampling and Laboratory Analysis. All sampling and laboratory analysis required by applicable permits and Acceptance Test procedures shall be performed by an independent firm (under subcontract to the Company) who is qualified in such matters and acceptable to City.

(G) Data. All measurements shall be read and recorded at an interval to be specified in the Acceptance Test Plan. Copies of all data recorded during each Acceptance Test shall be delivered by the Company to City.

(H) Test Procedures. Acceptance Testing shall be performed in accordance with applicable ASTM, EPA and other recognized procedures and shall be conducted in accordance with the latest edition of the respective test procedure in effect at the time the testing is conducted.

(I) Commencement of Acceptance Tests. The Company may commence Acceptance Testing pursuant to Section 6.12 of the Service Agreement at the Company's discretion so long as:

- (1) The Acceptance Test Plan developed in accordance with Section 6.12 of the Service Agreement has been approved by City or any dispute with regard to such Acceptance Test Plan has been resolved in accordance with Section 6.12 of the Service Agreement;
- (2) The company has provided City with the prior notice required pursuant to Section 6.12 of the Service Agreement; and
- (3) The calibration log set forth in Section 6.2(E) of Appendix 6 has been submitted by the Company to City and City agrees that all instruments requiring calibration have been calibrated.

6.3 Acceptance Test Report and Class A Facility Inspection

6.3.1 Acceptance Test Report. Upon completion of Acceptance Testing, the Company shall submit to City, in accordance with Section 6.16 of the Service Agreement, a written Acceptance Test report. The Acceptance Test Plan shall specify the contents of such report, which shall include, without limitation, the following:

(A) A certification from the Company that all Acceptance Tests were conducted in accordance with approved Acceptance Test Plan;

(B) A certification from the Company of the results of the Acceptance Tests including a determination by the Company of the extent to which the Class A Facilities complies with the Acceptance Test Standards;

FINAL VERSION

- (C) All data measured and recorded during the Acceptance Tests;
- (D) All calculation and computations;
- (E) The results of all laboratory analyses;
- (F) Any other data or analysis reasonably requested by the City to be included in such report;
and
- (G) A statement as to whether the Company intends to conduct additional Acceptance Tests and an estimated schedule of such testing.

6.3.2. Inspection. Upon completion of the Acceptance Tests, City and City's representative shall have the right, but not the obligation, to inspect any portions of the Class A Facilities that City chooses, including without limitation, internal equipment and components.

Appendix 7
Company's Performance Standards, Measurements and Guarantees

7.0 City/PMA Obligations or Actions

Where PMA is required under the Service Agreement to cause the City to take any action or to undertake any responsibility, those acts or responsibilities will be referred to in this Appendix as acts and responsibilities of the "City." Where the City has undertaken any obligation under the Service Contract, those obligations are also referred to in this Appendix as "City" obligations. Where PMA has authorized the City to receive, review or approve Company submittals these will be referred to in this Appendix as the "City" receipt, review or approval.

7.1 Performance Standards

The Company shall comply with the following Performance Standards while performing Biosolids Services for City including the processing and Beneficial Use of the City Biosolids during the Interim Period and the Class A Period. All Performance Standards are subject to excuse by reason of Uncontrollable Circumstances, Non-Conforming City Biosolids and City Fault.

7.1.1 Coordination with City

(A) **Biosolids Services.** The Company will plan, coordinate, and perform the Biosolids Services in a manner to prevent any interference with the operation of the City's wastewater pollution control plants or other facilities. The Company will coordinate with the City regarding all liquid biosolids receiving activities and related plant operations. The Company shall ensure that adequate storage space is available at the BRC to receive City Biosolids when delivered.

(B) **Weekly Schedule.** The Company and PMA will agree on and update a weekly schedule for receiving liquid biosolids. The Company will communicate on a daily basis with the City as needed to insure safe and efficient operating conditions. The Company will coordinate the weekly schedule with the City. The Company's anticipated schedule is to operate the BRC twenty-four (24) hours/day, five (5) days per week with start-up Monday and shutdown Friday, unless otherwise mutually agreed by the parties.

(C) **Startup and Shutdown.** The Company will provide proper notification to the City to coordinate planned start-up and shutdown of dewatering and drying operations. The Company will notify the City five (5) days ahead of time regarding scheduled down time for maintenance. The Company will notify the City immediately upon making a decision to have unscheduled maintenance activity. The Company will provide a record of startup and shutdown in the Monthly Reports.

FINAL VERSION

(D) Electrical Demand. Company will use its best efforts to assist the City in meeting the annual electrical demand requirements set by the electric utility for the combined BRC and SWWPCP account. The electric demand requirement is 10 Megawatts one time annually.

(E) Facility Manager. The Company's Facility Manager will be the primary contact for the PMA. The Company will also designate an assistant facility manager in case the Facility Manager is unavailable.

(F) Emergency Contact. The Company will provide the City with emergency contact telephone numbers, and the City will provide the Company with emergency contact telephone numbers

(G) Security. The Company will comply with the terms of the approved Security Plan identified in Appendix 1.

(H) Non-Company Construction or Operations. The Company's services and work will be coordinated with the City and City contractors to minimize conflicts, delays, and interruption to other City construction or operating contracts progressing concurrently with the Company's Biosolids Services or construction work.

(I) Unforeseen Events. The Company will recognize and cooperate with the City to accommodate various unforeseen or scheduled events that may affect its regular operation of facilities at the BRC Site, including events such as disruption of barging service, a barge being out of service, draining and filling of digesters, loss of electrical power, loss of water supply, required electricity curtailment, maintenance of a sludge transfer system, one or more City water pollution control plants being partially or completely out of service, and City employee strikes or other labor actions.

7.1.2 Stormwater Management

Company will utilize industry-standard best management practices in the operation of Biosolids Service, maintenance of Existing and Class A Facilities and the construction of Class A Facilities including stormwater systems and controls within the Company's Leased Premises.

7.1.3 Management of Nonconforming Biosolids

Company shall manage all Nonconforming Biosolids in accordance with good industry practice and Applicable Law.

7.1.4 Air Emission and Odor Control

FINAL VERSION

- (A) During the Interim Period the Company will control odor and air emissions by elimination of composting operations and use of odor control products or other methods as necessary.
- (B) During the Class A Period, the Company will provide air emission and odor control equipment and services in compliance with the required environmental permits and the service conditions specified in the Service Agreement.
- (C) At all times, Company shall comply with Applicable Law.
- (D) At all times, Company shall comply with the applicable requirements of Appendix 3.

7.1.5 Noise Restrictions. All Company Biosolids Services performed within the limits of the City, including the construction and operation of the Class A Facilities, will comply with applicable provisions of the Philadelphia Noise Ordinance. For Biosolids Services performed outside the City limits, the Company shall comply with all applicable local, state, or federal laws and regulations.

7.1.6 Safety. The Company will design and implement a comprehensive project-specific safety, health and loss prevention program and employee substance abuse program for all aspects of the Biosolids Services (Safety Program) consistent with the Contract Standards, including requirements in Appendix 1.

7.1.7 Good Industry Practices. The Company shall comply with all applicable Good Industry Practices while performing Biosolids Services for the City including the processing and Beneficial Use of the City Biosolids during the Interim Period and the Class A Period.

7.1.8 Applicable Law. The Company shall comply with all Applicable Law while performing Biosolids Services for the City including the processing and Beneficial Use of the City Biosolids during the Interim Period and the Class A Period.

7.1.9 Permit Requirements. The Company shall comply with all applicable federal, state, and local permits and other Governmental Approvals while performing Biosolids Services for the City including the processing and Beneficial Use of the City Biosolids during the Interim Period and the Class A Period.

7.2 Performance Measurement

7.2.1 Calculation of Dewatered City Biosolids

To determine the total monthly Dry Tons of Dewatered City Biosolids processed by the Company during the operation of the dewatering facility and thermal drying process the following calculations and measurements will be used:

$$\text{Dewatered City Biosolids} = \text{D-F}$$

FINAL VERSION

Where:

- (A) Daily Received NE Flow (MGD) x Daily NE % TS x 41.7 = NE Dry Tons Per Day
- (B) Daily Received SW Flow (MGD) x Daily SW % TS x 41.7 = SW Dry Tons Per Day
- (C) Total Daily Received Dry Tons = Daily Received NE Dry tons + Daily Received SW Dry tons
- (D) Monthly Total Received Dry Tons = Sum of Total Daily Received Dry Tons for a month
- (E) Daily Centrate Flow (MGD of Return Flow #1) x Daily Total Suspended Solids (mg/l) x .00417 = Centrate Dry Tons Per Day
- (F) Monthly Dry Tons of TSS in Centrate = Sum of Daily Dry Tons of TSS in Centrate For a Month

EXAMPLE CALCULATIONS For (A), (B), (C) and (E)

- (A) Northeast daily flow at 1,036,572 gallons at 2.31% TS
 $1.037 \text{ MGD} \times 2.31 \text{ TS} \times 41.7 = 99.9 \text{ DT}$
- (B) SW daily flow at 1,610,359 gallons at 2.23% TS
 $1.610 \text{ MGD} \times 2.23 \text{ TS} \times 41.7 = 149.7 \text{ DT}$
- (C) Total Daily Received DT: $99.9 + 149.7 = 249.6 \text{ DT}$
- (E) Centrate flow of 2,598,723 gallons, TSS of 1136 mg/l
 $2.599 \times 1136 \times .00417 = 12.3 \text{ DT}$

7.2.2 Flow Measurement

Flow measurements are to be performed using the following procedures unless otherwise mutually agreed to by the parties.

- (A) Southwest Water Pollution Control Plant: Received Flow from the SWWPCP will be read using the incoming sludge magnetic flow meters located on the two 10" sludge feed lines inside the dewatering facility know as "line A" and "line B." A flow meter totalizer is read at the beginning and end of each twenty-four (24) hour period to report the totaled Gallons Per Day ("GPD"). In the event that the flow meters are not accurately working then the total flow can be calculated by adding the total amount of sludge going

FINAL VERSION

to each centrifuge that is processing the SWWPCP sludge and any change in the SWWPCP sludge storage tank(s) elevations (one foot of tank elevation = 46,000 gallons) during the 24 hour period. The SWWPCP also has flow meters with totalizers available if required.

(B) Northeast Water Pollution Control Plant: Received Flow from the NEWPCP will be reported to the Company from the NEWPCP on a per barge basis. For the daily totaled flow received, the quantity will be reported for the twenty-four (24) hour period that the barge begins its unloading operation. The incoming sludge magnetic flow meter, located on the 16" barge unloading line inside the dewatering facility can be used to verify quantities unloaded from the barge but will need careful attention since the meter is sometimes empty (inaccurate) when a barge is not being unloaded. In the future, if the Company decides to make modifications to the meter or to the operating procedures and can prove to the City that the totalized readings are accurate, then the City may accept this quantity as the flow received from the NEWPCP. In the event that the quantity is not available from the NEWPCP then the total daily flow received can be calculated by adding the total amount of sludge going to each centrifuge that is processing the NEWPCP sludge and any change in the storage tank elevations (one foot of tank elevation = 46,000 gallons) during the twenty-four (24) hour period. The NEWPCP may also be able to calculate the barge load through an alternative calculation to help verify the data if required.

(C) Centrate flow (Return Flow #1) delivered to the SWWPCP from the dewatering facility will be read using the magnetic flow meter located on the 14" centrate return line which is located in the dewatering facility. A flow meter totalizer reading is read at the beginning and end of each twenty-four (24) hour period to report the totaled gpd. In the event that this flow meter is not accurately working, then historical information will be used to determine the total GPD.

(D) Return flow from the Class A Facility will be read from a flow meter installed by the Company. This flow meter and totalizer will be used to report the totaled gpd. In the event that this meter is not working accurately, historical information will be used to determine the totaled GPD.

(E) It is the Company's responsibility to keep incoming sludge and return flow meters and totalizers located in the Dewatering Facility in working order. An agreed upon annual third party calibration of these meters will be performed at the Company's expense. Any discrepancies in the data reported by the Company from those observed or calculated by the City will be brought to the attention of the Company and resolved to the City's satisfaction. Company will make all commercially reasonable efforts to repair or replace any flow meter that is not accurately working as soon as possible.

7.2.3 Sampling

FINAL VERSION

Sampling is to be performed using following procedures unless mutually agreed between parties. The Company reserves the right to split samples and have samples analyzed by an independent laboratory at the company's expense.

(A) The samples taken for the SWWPCP and the NEWPCP daily Percent Total Solids (%TS) will be taken manually from the sample taps located on the discharge of the sludge feed pumps from their respective tanks. A sample will be taken every four (4) hours but under no circumstance less than every eight (8) hours for each plant sludge being processed. This could be a NEWPCP sludge sample, a SWWPCP sludge sample or both (if both sludges are processed during a shift. An average of all sample results taken of a particular plant's sludge in a 24 hour period will be used as the daily %TS. Samples will be delivered by the Company, on a daily basis, to the SWWPCP laboratory for %TS analysis along with the proper "chain of custody" forms required by the City for such samples.

(B) The sample taken for the centrate daily Total Suspended Solids (TSS) will be from an automatic composite sampler located by the centrate wet well in the dewatering facility. The sampler will be located on the in-service centrate well. The second well will remain out of service and serve as a spare well. This composite sampler will be programmed to take a measured sample of centrate every fifteen (15) minutes from the wet well during the 24-hour operating period to produce a single sample. In the event that the automatic composite sampler is not operational, a sample will be manually collected every four (4) hours but under no circumstances less than every eight (8) operating hours from the centrate pump discharge and the Company will make all commercially reasonable efforts to repair or replace the composite sampler as soon as possible. These samples will be delivered by the Company to the SWWPCP laboratory where the samples will be accurately composited (if required) into a single sample for TSS analysis. The Company will follow and document a "chain of custody" protocol for the delivery of all samples to the laboratory. This laboratory data will be used as the daily TSS for the centrate.

(C) The sample taken for the Class A Facility Return Flow #2 daily TSS will be from an automatic composite sampler. This composite sampler will be programmed to take a measured sample of effluent every fifteen (15) minutes from the scrubber during the 24-hour operating period to produce a single sample. In the event that the automatic composite sampler is not operational, a sample will be manually collected every four (4) but under no circumstances less than every eight (8) operating hours and the Company will make all commercially reasonable efforts to repair or replace the composite sampler as soon as possible. These samples will be delivered by the Company to the SWWPCP laboratory where the samples will be accurately composited (if required) into a single sample for TSS analysis. The Company will follow and document a "chain of custody" protocol for the delivery of all samples to the laboratory. This laboratory data will be used as the daily TSS for the Class A Facility.

(D) It is the Company's responsibility to collect all samples and to keep the composite samplers in working order. The City maintains the right to periodically inspect the Company's sampling protocol and to verify sampling procedures.

(E) This daily information and the calculated dry tons will be used to report all monthly average and annual reports which are required to verify the City's and the Company's compliance with the Service Agreement.

7.2.4 Digester Gas Measurement. Company shall be responsible for the metering of the amount of Digester Gas utilized at the BRC Site. Company shall develop a metering plan for review by PMA. Company shall read Digester Gas meters on a daily basis and record usage in a daily log. Company shall provide PMA with a monthly Digester Gas consumption report.

7.2.5 Monitoring, Testing, and Reporting

(A) The Company will be responsible for obtaining and maintaining all applicable federal, state and local approvals, licenses, permits and certifications required for performing the Biosolids Services in accordance with the terms and provisions of the Service Agreement. The preliminary list of Governmental Approvals is provided in Appendix 10. The Governmental Approvals listed in Appendix 10 may not be all encompassing and the Company will update the list as required.

(B) The Company will be responsible for implementing a program to monitor and report necessary constituents contained in the City's Biosolids, Return Flows, and Class B and Class A Product in accordance with applicable regulatory requirements. The Company will monitor the biosolids treatment process to ensure that optimum operation of the system is achieved and a quality finished product produced.

7.3 Performance Guarantees

The Company guarantees the following with regard to performing Biosolids Services for the PMA including the processing, disposal and Beneficial Use of the City Biosolids during the Interim Period and the Class A Period. All Performance Guarantees set forth below shall be subject to excuse to the extent of Uncontrollable Circumstances, Non-Comforming City Biosolids and PMA Fault.

7.3.1 Interim Period Class B Product Storage Guarantee. Company guarantees that during the Interim Period, Company shall not store more than 10,000 Tons of Class B or other Product that has been dewatered by the Company at the BRC Site.

7.3.2 Company's Class A Product Quality Guarantee. The Company guarantees that Product produced by the Class A Facilities will at least meet all federal requirements for "exceptional quality" Class A biosolids including 40 CFR Part 503.32(a) regarding pathogen reduction, Part 503.33 regarding vector attraction reduction, and 503.13 Table Three limitations for metals; and have a minimum solids content of ninety percent (90%).

7.3.3 Company's Annual Dewatering Capacity Guarantee. Company guarantees that it will have the capacity to dewater up to 70,000 Dry Tons of City Biosolids per Contract Year throughout the Term, based on an average annual City Biosolids at 2.50% (+/- .50%) total solids.

7.3.4 Company's Annual Class A Facility Capacity Guarantee. Company guarantees that once it begins operation, the Class A Facilities will be able to process up to 65,000 Dry Tons of Dewatered City Biosolids.

(A) Class A Facilities Operations Guarantee. Company guarantees that it will not ship off-site more than 4,000 Dry Tons per year of Class B Product during any Contract Year of the Class A Period.

(B) Class A Period Maximum Storage Guarantee. Company guarantees that it will not store more than 10,000 Wet Tons of Class B Product at the BRC Site at any time during the Class A Period.

7.3.5 Company's Return Flow Guarantee

(A) Return Flow #1 Guarantee

(1) During the Interim and Class A Periods the Return Flow # 1 (from Dewatering Operations), as specified above, will remain reasonably consistent with the operation existing prior to the Service Agreement Date in both its flow and chemical composition. Return Flow # 1 Capture Rate (CR) will be calculated as follows:

$$CR = \frac{TS_{in} - TSS_{out}}{TS_{in}} \times 100$$

Where:

CR - Capture Rate percent.

TS_{IN} - Amount of total dry solids delivered to the Facility from the City, dry tons. See 7.2.2(C).

TSS_{OUT} - Amount of suspended solids returned to the City from centrifuges, dry tons. See 7.2.2 (E)

(2) The Return Flow # 1 Capture Rate will not be less than ninety-three percent (93.0%) as determined on a yearly basis provided that the average percent of total solids of the sludge delivered to the Facility is 2.50% (+/- .50%) on a yearly basis.

(3) If the daily percent of total solids (TS) of the Conforming City Biosolids delivered to the Facility is less than 1.5% or greater than 6.0%, the amount of total dry

FINAL VERSION

solids delivered to the Facility and the amount of suspended solids returned to the City for that day will be removed from the calculation of the Return Flow # 1 Capture Rate Guarantee.

- (4) Suspended Solids Guarantee. The Company guarantees that the Return Flow # 1 total suspended solids discharge shall not exceed:
 - (a) 25 Dry Tons per Day
 - (b) 5,475 Dry Tons per Contract Year
- (5) Return Flow #1 Discharge Guarantee. The Company guarantees that the Return Flow #1 discharges shall not exceed:
 - (a) 4.5 MGD
 - (b) 3.25 MGD Contract Year average

(B) Return Flow # 2 Guarantee

- (1) Suspended Solids Guarantee. The Company guarantees that the total suspended solids in Return Flow # 2 shall not exceed 2% of the solids contained in the City Biosolids for a 24 hour period: if the daily percent of total solids of the biosolids delivered to the Facility is less than 1.5% or greater than 6.0%, for that day, the amount of the total suspended solids (TSS) in the Return Flow # 2 will be removed from the calculation of the Return Flow # 2 limit.
- (2) Flow Guarantee. The Company guarantees that the average Return Flow #2 for a Contract Year shall not exceed 3.5 MGD.

(C) Total Return Flow

- (1) Total Return Flow is sum of Return Flow #1 and Return Flow #2
- (2) Total Suspended Solids Guarantee. The Company guarantees that the total suspended solids in the Total Return Flow shall not exceed 6,570 Dry Tons per Contract Year.

7.3.6 Company's Class A Period Maximum Electricity Utilization Guarantee

(A) The Facility maximum electricity utilization will be no more than 375 kwh per Dry Ton of Dewatered City Biosolids provided that the average percent of total solids of the sludge delivered to the Facility is 2.50% (+/- .50%).

(B) If the daily percent total solids of the City Biosolids delivered to the Facility is less than 1.5% or greater than 6.0%, the amount of electrical utilization for that day will be removed from the calculation of the Maximum Electricity Utilization.

(C) If the actual Facility Throughput in a contract year is less than 57,000 Dry Tons of Dewatered City Biosolids, the Guaranteed Maximum Electricity Utilization will be adjusted in accordance with mutually agreed upon protocol.

7.3.7 Company's Class A Period Maximum Natural Gas Utilization Guarantee

(A) The Facility maximum natural gas utilization will be no more than 85 Therms per Dry Ton of Dewatered City Biosolids provided that the average percent of total solids of the sludge delivered to the Facility is 2.50% (+/- .50%).

(B) If the daily percent total solids of the biosolids delivered to the Facility is less than 1.5% or greater than 6.0%, the amount of natural gas utilization for that day will be removed from the calculation of the Maximum Natural Gas Utilization.

(C) If the actual Facility throughput in a Contract Year is less than 57,000 Dry Tons, the Guaranteed Maximum Natural Gas utilization will be adjusted in accordance with mutually agreed upon protocol.

7.3.8 Company's Class A Period Maximum Alternative Fuel Utilization Guarantee

(A) Excluding periods of mandatory interruption of natural gas delivery by the natural gas supplier, the Facility maximum Alternative Fuel utilization for #2 Fuel Oil will be no more than 85 Therms per Dry Ton of Dewatered City Biosolids provided that the average percent of total solids of the sludge delivered to the Facility is 2.50% (+/- .50%). Should PMA and the Company agree to utilize an Alternative Fuel other than #2 Fuel Oil, a maximum utilization guarantee for that fuel will be established at that time.

(B) If the daily percent total solids of the biosolids delivered to the Facility is less than 1.5% or greater than 6.0%, or if there is a mandatory interruption in natural gas supply, the amount of Alternative Fuel utilization for that day will be removed from the calculation of the Maximum Alternative Fuel Utilization.

(C) If the actual Facility throughput in a Contract Year is less than 57,000 Dry Tons, the Guaranteed Maximum Alternative Fuel utilization will be adjusted in accordance with mutually agreed upon protocol.

7.3.9 Company Digester Gas Utilization Guarantee. Company shall use commercially reasonable efforts to utilize all Digester Gas available for use at the BRC Site from the SWWPCP consistent with the gas infrastructure constructed for the Class A Facilities and in accordance with the specifications outlined below.

Based on processing 60,000 dry tons/year of Dewatered Biosolids, the Class A Facility shall utilize a minimum of 120,000 decatherms of digester gas/Contract Year subject to the City providing Digester Gas in accordance with the monthly delivery minimums and maximums described in this section.

(A) Digester Gas Quantity Specifications

(1) Anticipated Annual Average Use – 150,000 decatherms

(2) Minimum Guaranteed Annual Average Use – 120,000 decatherms
provided delivery occurs within the following monthly ranges.

(a) monthly minimum delivery 8,500 decatherms

(b) monthly maximum delivery 18,500 decatherms

(c) If the City delivers less than the monthly minimums in any month, the difference between the monthly minimum and the actual delivered amount will be subtracted from the Minimum Digester Gas Utilization Guarantee for the Contract Year.

Appendix 8

Class A Period Operation and Maintenance

8.0 City/PMA Obligations or Actions

Where PMA is required under the Service Agreement to cause the City to take any action or to undertake any responsibility, those acts or responsibilities will be referred to in this Appendix as acts and responsibilities of the “City.” Where the City has undertaken any obligation under the Service Contract, those obligations are also referred to in this Appendix as “City” obligations. Where PMA has authorized the City to receive, review or approve Company submittals these will be referred to in this Appendix as the “City” receipt, review or approval.

8.1 Company’s Class A Period Operation and Maintenance Responsibilities

For the entire Class A Period, the Company shall be responsible for the following:

8.1.1 Dewatering Operation

The Company shall continue to be responsible for the dewatering operations commenced at the end of the Transition Period as described in detail in Appendix 1.

8.1.2 Thermal Drying Operation

The Company shall be responsible for the Class A Facilities including the Thermal Drying Facility (TDF). Generally the Company’s responsibilities shall include:

- (A) reception and transport of the Dewatered City Biosolids conveyed from the Dewatering Operation;
- (B) operation of two Andritz DDS 110 thermal drying systems including air emission and odor control components;
- (C) TDF equipment maintenance, repair or replacement;
- (D) Product (pellet) storage, loading, transportation, marketing and Beneficial Use;
- (E) Personnel recruitment and training.

8.1.3 Monitoring and Testing

The Company shall be responsible for:

- (A) Daily analyses performed for the purpose of process control and system operations and maintenance (including implementation of the process monitoring protocol currently utilized by the City in its operation of the Existing Facilities, as such

protocol may be amended by the Company and approved by the City);

(B) The performance of all sampling and laboratory analyses (except those which may be performed by City under Appendix 7) required to determine compliance with Applicable Law and the Performance Standards and Guarantees and for the accurate preparation of invoices for the Class A Service Fee;

(C) Quality assurance and quality control (“QA/QC”) testing in conjunction with laboratory work. QA/QC methods shall include blanks, duplicates, spikes, percent recovery, method detection limit studies and/or other methods. A description of the QA/QC program and supporting analytical results shall be maintained in orderly files by Company’s laboratory and shall be summarized in an annual report and otherwise made available upon request by the City. The number of QA/QC samples shall be consistent with best industry practice. Company shall provide an electronic copy of all laboratory records to City on demand for auditing and other purposes.

8.1.4 Equipment. The Company shall keep all equipment in good operating condition. The Company shall maintain spare parts in inventory to facilitate repair and replacement of equipment in a timely fashion so as not to disrupt the operation of the Biosolids Services.

8.1.5 Computerized Maintenance Management System

(A) The Company shall implement a computerized maintenance management system (“CMMS”) to track and administer (including record keeping) maintenance activities and spare parts inventories. Maintenance activities shall be categorized (at a minimum) as follows:

- (1) Routine inspections and maintenance;
- (2) Safety inspections and maintenance;
- (3) Predictive maintenance;
- (4) Preventive maintenance; and
- (5) Corrective maintenance.

(B) The Company shall perform all testing as may be required by warranties, commercial or industrial standards and Applicable Law. The Company shall ensure that all protective shields, screens, and other safety devices are in place and fully functional at all times for the protection of personnel. The Company shall set up a separate database containing all biosolids equipment included in the Existing Facilities. All new equipment shall be set up in the database prior to generating preventive maintenance work orders.

8.1.6 Predictive Maintenance

(A) The Company shall conduct predictive maintenance to minimize the likelihood of machinery failure and to extend the useful life span. The Company shall use diagnostic tools, as appropriate.

(B) The Company may track process variables, such as temperature, vibration and amperage using the CMMS to identify statistical trends that predict equipment failure. These analyses will identify present and potential problems and predict when corrective action should be taken.

8.1.7 Preventive Maintenance. The CMMS shall alert the Company's maintenance personnel to investigate and make any necessary adjustments or repairs in order to avoid equipment failure. The Company's preventive maintenance shall include, but is not limited to:

- (A) lubrication;
- (B) maintenance of oil levels;
- (C) drainage of condensate;
- (D) verification of proper operation;
- (E) inspection and replacement of normal wearing parts; and
- (F) overhauls required by manufacturer or past history.

8.1.8 Renewal and Replacement. The Company shall be responsible for Renewal and Replacement of equipment and fixtures comprising the Class A Facilities and shall perform all such Renewal and Replacement of the Class A Facilities as may be necessary for Company to provide the Biosolids Services and comply with the Contract Standards, including the Performance Standards and Guarantees. Company shall determine in accordance with the Company's Renewal and Replacement obligations to City whether equipment is to be renewed or replaced. However, the Renewal and Replacement of equipment shall be of a quality and durability equal to or greater than the equipment being replaced. Equipment renewal shall restore the equipment's performance to a level equal to or greater than its original level. Equipment replaced or renewed shall also meet, at a minimum, prudent industry practice, the original engineering design specification, and the requirements defined in the manufacturer operations and maintenance manual.

8.1.9 Operating Reports

(A) The Company shall, in addition to any operating data provided separately, provide a monthly report to the City that includes the following:

- (1) Quantity of City Biosolids delivered on a dry ton basis, processed, reused and disposed of by the Company, including the processing method and the reuse and disposal locations;
- (2) Summary of significant operational and maintenance activities from the preceding month (including departures from standard operating procedures and corrective measures);
- (3) Narrative description of operational procedures and any operational changes;

FINAL VERSION

- (4) A summary of accident reports and other safety-related issues;
 - (5) A summary of staff and an updated organization chart, noting all filled and vacant positions; and
 - (6) A summary of electricity, natural gas, digester gas and alternative fuel for the prior month.
- (B) The monthly operating reports will also include such additional information that the City may reasonably request.
- (C) The Company will submit to the City an annual report no later than sixty (60) days after each Agreement Year. The content of such annual report will be as agreed by the City and the Company.
- (D) The Company will, in addition to any operating data provided separately, provide to the City a monthly Equipment Status Report.
- (E) The Company will, in addition to any operating data provided separately, provide the City with real time but read only access to computer monitoring of the three storage tanks, the three flow lines (A flow line, B flow line, and centrate flow line), and the barge transfer meter.

8.1.10 Notice of Necessary Information. The Company will prepare and sign a Notice and Necessary Information (NANI) form certifying to the preparation of the biosolids in conformance to Federal and State regulations.

8.1.11 Buildings and Grounds. The Company shall maintain a high state of cleanliness in all aspects of its operations. The biosolids handling area shall be cleaned daily. Vehicles and solids containers shall be cleaned at least weekly. The Company shall maintain the BRC Site grounds and landscaping in an aesthetically attractive and clean condition in accordance with all applicable provisions of the Lease.

8.1.12 Operation and Maintenance Procedures

- (A) The Company will maintain current written maintenance and operating procedures, including:
- (1) Standard operating procedures (including safety procedures);
 - (2) Standard maintenance procedures;
 - (3) Annual maintenance, renewal, and replacement plan.
- (B) All such procedures shall be submitted to the City before the ATSA Date. Any changes in such procedures shall be submitted to the City no later than five (5) business days after going into effect.

8.1.13 Contingency Plan

(A) At or before the ATSA Date, the Company will provide to the City for its review and comment an updated Contingency Plan ensuring the continued provision of the Biosolids Services in the event of occurrences that might otherwise interrupt such services, including a backup disposal plan. The Contingency Plan will address how Company will continue to fulfill its contractual obligations under adverse circumstances, including the but not limited to the following:

- (1) Failure of a significant piece or pieces of equipment;
- (2) Failure to generate Product within established standards;
- (3) Failure of the reuse market (including an explanation of how the Company will dispose of any Product that remains unsold, with a further back up plan for any alternative, if applicable);
- (4) Inaccessibility of proposed haul routes; and
- (5) Failure of proposed disposal location or method.

(B) The Contingency Plan shall be updated with each annual report and at all such other times as may be required.

8.1.14 TDF Down Time. During periods of planned maintenance and repair downtime, or emergency breakdown, the Company shall divert City Dewatered Biosolids to Class B Product operations or to landfill options. During these periods, the Company may utilize the CTSF for staging and storage prior to transport off site but shall store no more than 10,000 Wet Tons of Class B Product or other Product. The Company shall remove all temporarily staged and stored material from the CTSF as soon as possible after startup of the Class A Facility.

8.1.15 Staffing. During the Class A Period, the Company shall employ an adequate number of full-time operations, maintenance and management personnel at the BRC Site to provide the Biosolids Services.

8.1.16 Training Plan. Before the ATSA Date, the Company shall provide to City an updated Training Plan.

8.2 City's Class A Period Operation Responsibilities

8.2.1 Biosolids Delivery. City shall deliver City Biosolids to the Dewatering Facility as described in detail in Appendix 1.

Appendix 9

Class A Product Reuse and Disposal

9.0 City/PMA Obligations or Actions

Where PMA is required under the Service Agreement to cause the City to take any action or to undertake any responsibility, those acts or responsibilities will be referred to in this Appendix as acts and responsibilities of the "City." Where the City has undertaken any obligation under the Service Contract, those obligations are also referred to in this Appendix as "City" obligations. Where PMA has authorized the City to receive, review or approve Company submittals these will be referred to in this Appendix as the "City" receipt, review or approval.

9.1 Company Responsibility

The Company shall have complete responsibility for the testing, hauling, storage, marketing, reuse, and, where necessary, disposal of all Class A Product and any other materials (such as Product that is not Class A Product due to Nonconforming City Biosolids or Company Fault).

9.2 Marketing Plan

(A) The Company shall investigate available markets for the Class A Product and shall develop, maintain, periodically update (at least annually), and implement a plan for marketing the Class A Product. The Marketing Plan must include:

- (1) Description of existing markets for Class A Product;
- (2) Company's plans to develop/increase the markets and contingency plans for changes in markets;
- (3) Description of the challenges associated with marketing Class A Product and plan for overcoming these challenges; and
- (4) City's role in the Marketing Plan, if any (provided that any role proposed for the City is subject to the approval of the City).

(B) The final Marketing Plan must be submitted to the City no later than ninety (90) days prior production of Class A Product and any updates shall be provided promptly to the City.

9.3 Implementation of Marketing Plan

To successfully market the Class A Product, there is a series of tasks that will be included in the Company's Marketing Plan. They include:

FINAL VERSION

- (A) Obtain the necessary permits, product registrations, and licenses to legally distribute the Class A product;
- (B) Ensure a viable market is identified to which Class A Product can be shipped from day one of production;
- (C) Coordinate sales, transportation, and operations functions in order to achieve timely Class A Product loadout, thus preventing silos from over filling;
- (D) Identify and target the highest value markets with needs matching those of which the product can supply;
- (E) Develop an action plan to effectively maximize tonnage sold and sales revenues in each targeted market;
- (F) Collecting revenues for products delivered and sold.

9.4 Transportation

- (A) Company shall develop and implement a safe and efficient Transportation Plan for taking Class A Product and other materials to a their destination markets or disposal facilities.
- (B) Company shall provide to PMA a final Transportation Plan included in the Marketing Plan, which shall show final destinations, haul routes, site traffic flow, weather restrictions on hauling operations and alternate haul routes to be used in the event of a major accident or construction. Such information shall be provided for all materials to be brought to or taken from the BRC Site. Company shall provide an updated version of this plan with the Company's annual operations report and at such other times as changes to a primary route or final destination are made. PMA may request modifications to hauling routes that it deems pose an unacceptable level of public nuisance or risk. All vehicles used by Company shall be appropriate for the materials hauled (e.g., to minimize spills and leaks) and may be required to be clearly identified as belonging to Company. Such markings would be subject to PMA approval. Transport vehicles shall avoid residential streets to the greatest extent possible. Applicable Law shall be followed with respect to all transportation activities, including the use of placards for different materials being transported.

9.5 Spill Plan

Included in the Marketing Plan, the Company shall provide to PMA a plan describing actions to be taken to avoid spillage of materials and actions and plans to contain and cleanup any spillage that occurs or might occur in the Company's performance of the

Biosolids Services (“Spill Plan”).

9.6 Product Quality

(A) The physical qualities of the Class A Product or pellets (e.g., density and particle size) will be consistent with other fertilizer materials so that they can be readily blended and handled with standard fertilizer and agricultural equipment.

(B) The facility will produce approximately 60,000 tons/year of pellets. The pellets dryness will be in the 90% - 96% range and, the pellets will have a nutrient and metal content identical to the feed solids. The product will meet EPA 40 CFR § 503 requirements for Class A pathogen reduction and vector attraction reduction.

Appendix 10

Government Permits and Approvals**10.1 Applicable Law and Permitting**

The Company will comply with Applicable Law, including all regulatory requirements and environmental permits pertaining to the Biosolids Services. Such responsibility includes obtaining all permits, preparing and/or updating all planning documents, meeting all permit requirements, paying all permit fees (except as otherwise agreed in the Service Agreement), and paying any fines, penalties or judgments resulting from the failure of the Biosolids Services to comply with Applicable Law in accordance with the Service Agreement. Unless otherwise approved by PMA, all permits will be held in the Company's name.

10.2 Existing Permits and Licenses for the BRC Site

The City currently holds the permits listed in Table 10.1 below related to the treatment, production, and disposal of biosolids.

Table 10.1

EXISTING PERMITS AND APPROVALS HELD BY THE CITY FOR PWD BIOSOLIDS

Permit or Approval	Issuing Agency	Expiration Date	Description
101264	PADEP	August 12, 2008	Operating permit for BRC facility, with annual reporting requirement
PAG-080004	PADEP	March 31, 2008	General Permit for Beneficial use of Class B biosolids by Land Application 30,000 Dry Tons/yr., with annual reporting requirement
PAG-070004	PADEP	January 18, 2006	General Permit for Beneficial use of Class A biosolids (Screened Compost), with annual reporting requirement
NJ0142930-VI	NJDEP	December 31, 2008	Land application of out of state Exceptional Quality Residual, with quarterly reporting requirement and annual sludge quality assurance

Table 10.1

EXISTING PERMITS AND APPROVALS HELD BY THE CITY FOR PWD BIOSOLIDS

Permit or Approval	Issuing Agency	Expiration Date	Description
J99301	Waste Mgmt of PA	February 7, 2006	report Waste Management of PA -Landfill of municipal sewage sludge, with annual certification with hazardous waste characterization
N/A	MDE	January 31, 2006	Annual out of state sludge generators report Maryland, with bimonthly biosolids quality reporting requirement
V95-045	Phila AMS	June 1, 2006	Title V Operating Permit
NPDES Form 2S Application	USEPA	N/A	Sludge-only Facility Permit

10.3 New Permits or Approvals

The improvements at the BRC facility will require that many of the existing permits be modified and new permits or approvals be submitted to appropriate agencies. Company shall be responsible for securing all such permits and the related costs. PMA shall cause the City to cooperate with Company in providing information and meeting other regulatory requirements. These potential permits or approvals include the following.

10.3.1 PADEP/USEPA

A coordination meeting will be held with the PADEP and USEPA to discuss the proposed activities at the site to ascertain the extent and timing of permit requirements. Several new permits or modifications are expected to be required:

(A) NPDES Stormwater Permit Associated with Construction Activities – For areas of disturbance greater than 1 acre in size. This would include erosion and sedimentation plans, which in Philadelphia are submitted directly to PADEP Southeast Regional Office.

(B) Biosolids operating permits – Modifications to existing PADEP solid waste facility permit and USEPA Sludge only Facility Application and transfer of responsible parties may be required based upon changes in treatment process and application.

FINAL VERSION

(C) Biosolids Utilization permits – Existing coverage of compost (PAG-07004) and cake (PAG-08004) will need to be amended at a minimum to reflect change Biosolids Sampling Plan. For new biosolids products including mine mix and heat dried pellets, a new request for coverage under PAG-07004 and PAG-08004 will be required. Commercial distribution of Class A products may also require registration, under individual state fertilizer law, with the Department of Agriculture in states to which the products are delivered.

(D) Air permit – City of Philadelphia Air Management Services is the delegated regulatory authority but PADEP may have involvement. The Class A Facilities will include current Best Available Control Technology (BACT) for emissions control for similar facilities. Modification of the Class A Facilities to meet emission limits that are more stringent than that achievable from the use of current BACT are outside the scope of this Service Agreement.

10.3.2 City of Philadelphia

(A) The City of Philadelphia recently adopted the 2003 International Code Council (ICC) codes for construction activities. Under this new code, the following permits may be required from the Department of Licenses and Inspections:

- (1) Building Permit (demolition and/or new building construction)
- (2) Electrical Permit
- (3) Fire Permit (coordinated with Philadelphia Fire Department)
- (4) Plumbing Permit
- (5) Zoning/Use Registration Permits

(B) Also the City's Air Management Services (AMS) would be the responsible agency for modifications or new permits as it relates to the air emissions.

10.3.3 Philadelphia Gas Works (PGW)

Coordination with PGW would be required if demolition or new construction would involve existing or new gas lines to the facilities.

10.3.4 PECO/Excelon

Coordination with PECO/Excelon for demolition of existing electrical services or new services that might be required outside of the property boundary.

10.3.5 Philadelphia Water Department

Coordination with the City on any new services for potable water or sanitary sewer to a new facility at the BRC site.

10.3.6 Permit Applications and Reporting

All applications and related documents associated with permitting and regulatory processes shall be reviewed by the City before submission to a regulatory agency. Except as otherwise expressly stated in the Service Agreement, the Company shall provide the City with a minimum of two (2) weeks to review any such proposed submissions and shall revise such documents where identified by the City as necessary to comply with the requirements of the Service Agreement. The Company shall include all permitting and regulatory compliance efforts in the Project Schedule and shall coordinate such efforts with the City. The Company shall prepare and submit all permit compliance reports and related documentation associated with the Biosolids Services. Copies of all such reports shall be submitted to the City simultaneously with submission to regulatory agencies, provided that the Company shall make best efforts to ensure that City shall be notified in writing at least two (2) business days in advance of the submission by Company of any permit violations or non-compliance reports or notices (unless otherwise required by law).

Appendix 11

Financing Plan

11.0 Principal Terms and Conditions - Primary Financing Plan

11.1 Purpose

To provide funds for the delivery of a Class A Dryer Facility at the Biosolids Recycling Center (“BRC”) by Philadelphia Biosolids Services, LLC (PBS) (the “Borrower”) in conjunction with the Philadelphia Municipal Authority (PMA).

11.1.2 Type of Financing

The Primary Financing Mechanism is expected to be tax exempt bonds issued by or through the Philadelphia Authority for Industrial Development (PAID) with a possibility of taxable bonds issued contemporaneously in the event that sufficient volume cap allocation is not available at the time of bond sale.

11.1.3 Alternate Financing

In the event that financing cannot be secured through the Primary Financing Mechanism, Borrower reserves the right to secure financing through any means available, including Variable Rate Financing, subject to the limitations of Section 8.3 of the Service Agreement.

11.2.0 Proposed Bond Issuer

Philadelphia Authority for Industrial Development (“PAID”).

11.2.1 Borrower

Philadelphia Biosolids Services, LLC (PBS). Note: PBS, LLC anticipates the need for creation and use of an affiliate project entity in the course of financing this project. For example, bond funds may be received by an affiliate company of PBS (the “Financing Entity”) and then provided to PBS via a sales/lease back transaction, as follows: (1) PBS will sell the PBS-owned Improvements to the Financing Entity, in exchange for money which has been received by the Financing Entity in the form of bond funds. The Financing Entity’s ownership of the Improvements serves as security for the bond funds; then (2) the Financing Entity shall immediately lease back such Improvements to PBS in exchange for rent. PBS can then perform its obligations under the Service Agreement just as if it owned the Improvements, and the rent paid by PBS to the Financing Entity is used by the Financing Entity to repay bond holders.

PBS will keep PMA apprised if this need arises and the particulars thereof. For purposes of this Finance Plan, however, PBS alone is listed as “Borrower”.

11.2.2 Project Builder/Operator

Philadelphia Biosolids Services, LLC (PBS).

11.2.3 Term of Bonds

Final maturity for the tax exempt bonds may be approximately 22 years from issuance to cover expected two-year construction and acceptance testing period plus the 20-year duration of the service agreement between Borrower and PMA. Maturity of any taxable bonds necessary would be shorter in term reflecting structuring providing for paying off principal of higher interest taxable bonds before any principal on the tax-exempt bonds is repaid.

11.2.3 Bond Structure

Tax-Exempt and/or taxable fixed or variable rate bonds structured to yield level debt service payment.

11.2.5 Equity Participation

PBS shall contribute Additional Capital in the amount of \$7 million. PMA will provide a return on that Additional Capital of \$840,000 per year beginning in the first year of the drying facility's operation as detailed in Section 8.3 of the Service Agreement. If additional equity is required to obtain financing PBS shall increase its capital contribution up to \$15 million.

11.2.6 Type of Bonds/Allocation

The bonds would be tax exempt "private activity," "exempt facility" bonds based on use by the Company for certain solid waste and/or sewage/water treatment projects. Each state is limited in the number of such bonds that may be issued each year and, therefore, require approval of a "statewide volume cap" allocation from the Pennsylvania Economic Development Financing and Authority (PEDFA). PMA agrees to cooperate with and support the Borrower and PAID in pursuit of volume capital allocation for this Service Agreement financing.

11.2.7 Prepayment Penalties

For fixed rate bonds, prepayment would generally be allowed after 5-10 years, subject to negotiation at the time of bond sale. The shorter the period during which no prepayment is allowed, the higher the interest premium.

11.2.8 Credit Enhancement

PBS may seek Bond Insurance or provide a Letter of Credit.

11.2.9 Reserve Fund

It is expected that a Debt Service Reserve fund in an amount approximately equal to one year's debt service will be required and funded out of bond proceeds. Interest earnings from the Debt Service Reserve fund shall be Miscellaneous Credits as applied to the Class A Service Fee in Section 8.3 of the Service Agreement. In the event the fund is drawn upon by the Trustee to make a scheduled payment of principal or interest, the Borrower would be required to replenish the fund within a period specified in the Credit and Reimbursement Agreement.

11.2.10 Amortization

Borrower expects level mortgage style amortization over the 20 year term of the bonds. Interest only payments during the construction period will be paid from bond proceeds.

11.2.11 Advance Rate, Drawdowns

The proceeds of the bond issue will be held by the Bond Trustee. The Trustee, approved by the Issuer, will hold bond funds in an interest bearing account until withdrawn pursuant to periodic requisitions of the Company during construction. Requisitions may be approved by the Letter of Credit bank consistent with construction provisions of credit and reimbursement agreement.

11.2.12 Collateral/Security for Bank

The bank will be secured with a leasehold deed of trust on the Project Site and a security interest in the Service Agreement to be executed between Borrower and PMA. Bank will also be secured by a UCC filing on all personal property of the Borrower related to the Project. No guarantees of PBS or Synagro are expected to inure to the benefit of the bank although Synagro will guarantee the Borrower's performance under the Service Agreement to PMA.

11.2.13 Insurance

Company is required to maintain specified minimum levels of insurance acceptable to PMA and the Bank. Both to be named as additional insured as their interests require.

11.2.14 Indemnification

Borrower will give normal indemnification to bank for transactions of this type. Borrower will indemnify PMA and the City pursuant to the Service Agreement.

11.2.15 Disposition of Assets at Termination

At end of term of bonds and upon payoff of all sums due in respect thereof, unless the term of the Service Agreement shall have been extended, all physical assets of the Borrower comprising the Project will be turned over to the City at fair market value, unless PMA elects to have the assets removed by the Company.

11.2.16 Default/Remedies of PMA and Bank

In the event of default by Borrower, after giving effect to reasonable cure period (except in the instances of voluntary bankruptcy and the like) the Bank will have a limited right to cure and/or the right to propose an alternate operator, subject to the reasonable approval of PMA. The provisions of the Service Agreement shall remain in effect for any new operator (or a new agreement will be executed by PMA with the same terms and conditions if the previous agreement shall have been terminated for any reason, including action by a bankruptcy court). If no new operator can be found, PMA will have two options. It can terminate the Service Agreement and demand that the Borrower or the Bank restore the site to its previous condition. In such event, the Bank would have the right to remove and sell any of the Borrower's assets. Or, PMA may choose to retain the assets by purchasing them from the Bank, at a price to be negotiated.

Appendix 12

Insurance Requirements

12.1 Required Insurance

The Company shall procure and maintain in full force and effect, covering the performance of the Biosolids Services, the types and minimum limits of insurance specified herein. Except for the Professional Liability and Environmental Impairment or Pollution Liability insurance, all policies shall be written on an “occurrence” basis and not a “claims-made” basis. In no event shall work be performed until the required evidence of insurance has been furnished. The insurance shall provide for at least thirty (30) days prior written notice to be given to the City in the event coverage is cancelled or non-renewed; however, ten (10) days written notice will be provided if the insurance is cancelled due to non-payment of the premium. Company shall provide notice to PMA within thirty (30) days in the event that there is a reduction of coverage or change in the limit of coverage. Also, except for workers compensation and professional liability insurance, PMA, the City of Philadelphia, its officers, and employees shall be named as additional insureds in connection with this Agreement. In addition, an endorsement is required stating that the coverage afforded PMA, the City and its officers, and employees as additional insureds, will be primary to any other coverage available to them.

12.2 Coverage Requirements

(A) Workers’ Compensation and Employers’ Liability

- (1) Workers’ Compensation Statutory Limits
- (2) Employers’ Liability: \$1,000,000 Each Accident – Bodily Injury by Accident; \$1,000,000 Each Employee- Bodily Injury by Disease; and \$1,000,000 Policy Limit – Bodily Injury by Disease
- (3) Other states insurance including Pennsylvania

(B) General Liability Insurance

- (1) Limit of Liability: \$1,000,000 per occurrence combined single limit for bodily injury (including death) and property damage liability: \$1,000,000 advertising injury; \$2,000,000 general aggregate and \$2,000,000 aggregate for products and completed operations. The City may require higher limits of liability if, in the City’s sole discretion, the potential risk to warrants.
- (2) Coverage: premises operations; personal injury and property damage liability; products and completed operations; independent contractors, employees and volunteers as additional insureds; cross liability; broad form property damage (including completed operations), explosion, collapse, underground (“XCU”) coverage.

(C) Automobile Liability Insurance

FINAL VERSION

- (1) Limit of Liability: \$1,000,000 per occurrence combined single limit for bodily injury (including death) and property damage liability.
 - (2) Coverage: Owned, non-owned, and hired vehicles.
- (D) Umbrella Liability Insurance
- (1) Limit of Liability: \$10,000,000 per occurrence and in the aggregate, which shall be increased to \$25,000,000 per occurrence during any renovation or construction period, when combined with insurance required under (A), (B) and (C) above.
 - (2) Coverage: Umbrella Liability Form; coverage on pay-on-behalf basis; first dollar defense.
- (E) Builders Risk Insurance (during renovation/construction period)
- (1) Insurance shall be equal to the value of the project, on a replacement cost basis and shall also cover property to be incorporated into the project stored off-site and in transit.
 - (2) Insurance shall cover the interests of PMA, the City, Company and Subcontractors, as their interests may appear, which shall insure against physical loss or damage to all property incorporated or to be incorporated in the project, including temporary buildings used for storage of property to incorporated into the project and shall cover reasonable compensation for Company's or Subcontractors' services or expenses required as a result of such insured loss.
- (F) "All Risk" Property Insurance
- (1) "All Risk" property insurance covering the premises (including the Leased Premises), all improvements, betterments, equipment, trade fixtures, merchandise, business personal property and any other property in Contractor's care, custody or control, in an amount equal to the agreed valuation replacement cost with no penalty for coinsurance.
 - (2) Boiler and machinery insurance against loss or damage from explosion, erupting, collapsing, exploding or mechanical breakdown of boilers and pressure vessels and all equipment parts thereof and appurtenances attached thereto to the extent applicable to the premises.
 - (3) Business interruption insurance covering loss of profits, rent and necessary continuing expenses for interruptions caused by any one occurrence covered by the insurance referred to in subsections (1) and (2) above, subject to a coverage limit of \$50,000,000.
- (G) Professional Liability Insurance. Company shall cause its professional subcontractors for architectural, design, testing and/or engineering services to carry the following coverage and limits:
- (1) Limit of Liability: \$5,000,000 per claim with a deductible not to exceed \$250,000
 - (2) Coverage: Errors and omissions.

- (3) Professional Liability Insurance may be written on a claims-made basis provided that coverage for occurrences arising out of the performance of the services required under the Contract shall be maintained in full force and effect under the Policy or “tail” coverage for a period of at least two (2) years after expiration of this Agreement.

(H) Environmental Impairment or Pollution Liability Insurance

- (1) Limit of Liability: \$5,000,000 per claim and in the aggregate for bodily injury and property damage, with a deductible not to exceed \$250,000.
- (2) Coverage: sudden and accidental occurrences. Can be written on a claims-made basis, provided that coverage for occurrences arising out of the performance of the services required under this Agreement shall be maintained in full force and effect under the policy.

12.3 Changes to Insurance Requirements. From time to time, and in any event not more frequently than once per year, the PMA may reasonable adjust the amounts, types and deductibles of the insurance coverage required hereunder.

12.4 Additional Insureds. Company shall require that all of its contractors, subcontractors and consultants obtain and maintain, at their respective cost and expense, the appropriate types and amounts of insurance covering the work and their performance of services, naming PMA, and the City of Philadelphia as an additional insured in conformance with the requirements above.

12.5 Certificates of Insurance. Certificates of insurance evidencing the required coverages must specifically reference this Agreement and shall be submitted to PMA, the City of Philadelphia’s Water Department and Risk Management Division at least ten (10) days before initiation of any Biosolids Services or work and promptly, upon binding of the renewal, after each insurance renewal date. The ten (10) day requirement for advance documentation of coverage may be waived in situations where such waiver benefits the PMA, but under no circumstances shall Company actually commence services or begin work (or continue work, in the case of insurance renewal) without providing the required evidence of insurance. Company shall furnish certified copies of the original policies required hereunder at any time within ten (10) days after written request by PMA.

12.6 No Limit to Liability. The insurance requirements set forth herein shall in no way be intended to limit, modify or reduce Company’s indemnification obligations or limit Company’s liability to the limits of the policies of insurance required hereunder.

Appendix 13

M/W/DSBE Participation

13.1 The City, pursuant to the policies stated in Mayoral Executive Order 2-05, has established goals and participation ranges for Minority (MBE), Women (WBE) and Disabled (DSBE) Owned Business Enterprises (collectively, “M/W/DSBEs”) in all aspects of the Project. Goals and participation ranges have been developed for both equity participation in the Project and the provision of services related to the Project during the design, construction and operations phases. The Company must submit evidence to the City that it has made maximum practicable effort to meet or exceed these goals and participation ranges. Such evidence shall include the submission of a Solicitation and Commitment Form entitled, “Instructions, Forms and Contract Provisions For the Participation of Minority, Women and Disabled Business Enterprises (M/W/DSBE)” to the City of Philadelphia Minority Business Enterprise Council (MBEC).

13.2 The Company is committed to compliance with the goals and participation ranges outlined in the RFP and herein. Goals and participation ranges have been identified for five separate areas related to the delivery of Biosolids Services under the Service Agreement:

- Equity
- Interim Operations
- Design
- Construction
- Long Term Operations - Class A Period

The Company shall manage the provision of Biosolids Services in a manner that accomplishes the City’s program goals:

- (A) Meet or exceed the RFP stated M/W/DSBE goals and participation ranges.
- (B) Maximize the business impact on a focused number of M/W/DSBE firms, so as to facilitate increasing their overall capability to provide services to all sectors.
- (C) Consistent with the long term nature of the Service Agreement, utilize M/W/DSBE firms over the 23-25 year term of the project, thereby giving M/W/DSBE firms a stable business volume on which to base future growth.

A breakdown of planned M/W/DSBE participation by project phase is provided as Table 1.

Table 1

M/W/DSBE PARTICIPATION PLAN

PROJECT PHASES	PROJECT COSTS TOTAL	ELIGIBLE COSTS TOTAL	DBE DOLLARS	PERIOD	% PART.	RFP GOALS	TOTAL M/W/DSBE DOLLARS
EQUITY	100%	100%	N/A	24 YEARS	30%	15%	N/A
INTERIM OPS	\$16,681,000	\$5,498,607	\$2,749,304	4 YEARS	50%	28-50%	\$10,997,216
DESIGN	\$2,782,386	\$2,782,386	\$1,014,000	LUMP SUM	40%	32-45%	\$1,014,000
CONSTRUCTION	\$39,143,711	\$21,568,068	\$8,450,000	LUMP SUM	39%	33-55%	\$8,450,000
LONG TERMS OPS	\$15,418,000	\$6,715,000	\$1,880,000	20 YEARS	28%	28-50%	\$37,600,000
PROJECT TOTAL							\$58,061,216

13.3 M/W/DSBE Participation Submittal Schedule

Unlike traditional construction or service projects, this Project is utilizing a Design/Build/Own/Operate (DBOO) procurement approach. Not all of the design, engineering and permit elements necessary to establish the final scope of work are available at the date of execution of the Service Agreement. More specific M/W/DSBE participation, therefore, will be submitted to MBEC on the following schedule:

Estimated Date	Nov. 2004 (completed)	April. 2006	Oct. 2007	Oct. 2009
Equity	At RFP			
Interim Operations		At Contract Execution		
Design		At Contract Execution		
Construction			Prior to Start of Construction	
Long-Term Operations Class A Period				Prior to Start of Class A Operations

13.4 Equity Participation. Equity participation means participation which constitutes beneficial ownership by MBEs and WBEs in the Company. Equity Participation was previously submitted and accepted by MBEC during the RFP process. Subsequent to being selected for negotiations, the operating agreement for the Company, Philadelphia Biosolids Services LLC, was filed documenting M/W/DSBE equity participation of 30% as follows:

Firm	Commitment
McKissack & McKissack (WBE) 721 Chestnut Street Philadelphia, PA 19106	20% Equity
Len Parker & Associates (M-DBE) 40 W. Evergreen Avenue Philadelphia, PA 19118	10% Equity

All terms for the LLC have been agreed between the three equity members.

13.5 Interim Operations. PBS will utilize the services of Len Parker & Associates (LPA) to manage M/W/DSBEs during the Interim Operations. LPA will provide all outsourced dispatch and transportation services required by Company. LPA will solicit transport services to achieve 50% participation from Philadelphia Certified M/W/DSBE firms from the various DBE firms on the following list:

Alpha Waste Hauling
5 Blue Spruce Drive
Erial, NJ 08081
Dorian Evans
267-718-0031

Global Remediation Technology
1380 Barrowdale Road
Rydale, PA 19046
Robert Henderson
215-740-8039

Hank Beasley Trucking
8 Mark Anthony Circle
Morrisville, PA 19067
Hank Beasley
215-736-1251

J.K.T. Contractor and Development
242 South 51st Street
Philadelphia, PA 19139
Charles Hannah, Jr.
215-389-4664

Disposal Corporation of America
3433 Moore Street
Philadelphia, PA 19145
Ellen Ryan
215-463-2528

Jacobs Contracting Services
320 W. Decatur Avenue
Pleasantville, NJ 08324
609-484-0064

FINAL VERSION

LPA is in the process of obtaining quotes and securing subcontracts from this list of firms.

13.6 Design. McKissack & McKissack will be providing Design oversight for the Company (as the owner's representative). Company's primary design subcontractor, CH2M Hill, will be responsible for meeting Project Design M/W/DSBEs goals of 34% - 45%. CH2M Hill has initiated meetings and discussions relative to scope of work, project requirements and preliminary participation percentages with the following certified M/W/DSBE firms:

CH Planning (MBE and WBE)
1429 Walnut Street, Suite 1601
Philadelphia, PA 19102

UCI Architects, Incorporated (MBE)
1630 Pine Street
Philadelphia, PA 19103

ANG Associates, Incorporated (MBE)
1341 N. Delaware Avenue, Suite 500
Philadelphia, PA 19125

Hunt Engineering Company (WDBE)
18 East King Street
Malvern, PA 19355

The engineering work scope anticipated for the above firms is currently estimated at 40% of the total Design value of the Project. Table 2 provides the anticipated value of Design services provided by M/W/DSBEs and Table 3 provides the anticipated allocation of Design tasks. Final submittals will be made to MBEC for its review prior to commencement of Design work. Upon agreement of a mutually acceptable scope of work, professional services contracts will be executed with the certified M/W/DSBE firm(s).

Table 2

Scope	Estimated Percentage	Estimated Range
1. Permitting	2% - 3%	\$45k - \$75k
2. Survey	1% - 2%	\$25k - \$50k
3. Design Services & Services During Construction	29% - 34%	\$725k - \$840k
- Civil		
- Structural		
- Architectural		
- Building Services		
- Electrical		
4. PBS Design Override	8%	\$219k
Total:	40% - 48%	\$1.014M - \$1.184M

Table 3

Company Name	Address	Industry Type	DBE Certification
CH Planning Chanelle Hicks	1429 Walnut Street Philadelphia, PA 19102	Permitting	MBE and WBE
UCI Architects Ignatius Wang	1630 Pine Street Philadelphia, PA 19103	Architectural	DBE
ANG Associates, Inc. Charles Ang	1341 N. Delaware Ave., Suite 500 Philadelphia, PA 19125	Structural/Electrical/ Building Services	MBE
Hunt Engineering Co. Christine Hunt	18 East King Street Malvern, PA 19355	Survey/Civil	WBE

13.7 Construction. During the construction phase of the BRC project, the Company through its Design/Build subcontractor, CH2M Hill/Whiting Turner Joint Venture (JV) will continue to work closely with the MBEC to identify certified M/W/DSBEs for participation in construction work. CH2M Hill/Whiting Turner are coordinating with Len Parker Associates in the development of mechanical, plumbing and HVAC work scopes for the Project. Additionally, the JV has developed a list of firms for solicitation with the intent of identifying key M/W/DSBE firms for a competitive solicitation of work scopes presently under development.

The proposed participation for Construction will be submitted to MBEC prior to the commencement of Construction work. Upon agreement of a mutually acceptable scope of work and acceptable prequalification of firms, construction subcontracts will be executed with the selected certified M/W/DSBE firm(s).

Table 4 presents the Company's estimated scope of Construction work for all M/W/DSBE firms. Table 5 is a list of certified M/W/DSBE firms identified as qualifying for subcontract work. Since the commencement of Construction will likely be no earlier than 18 months following execution of the Service Agreement, the Company looks forward to receiving MBEC input for identifying additional qualified M/W/DSBE construction firms.

Table 4
Estimated Scope of Construction Work

Scope	Estimated Percentage	Estimated Range
Mechanical/HVAC/Plumbing		\$3.9M - \$4.5M
Demolition		\$500k - \$600k
Concrete/Civil		\$950k - \$1.2M
Civil/UG Utilities		\$700k - \$800k
Building Structural		\$2.4M - \$3M
PBS - Construction Oversight		\$1.5M
Total:	33% - 39%	\$8.45M - \$10.1M

Table 5
M/W/DSBE Construction Firms

Company Name	Address	Industry Type	DBE Certification
Len Parker Associates, Inc. Len Parker	718 Germantown Pike Lafayette Hill, PA 19118	Mech/HVAC/Plumb	M-DBE
Torrado Construction Company, Inc. Luis Torrado	3311-13 E. Thompson Street Philadelphia, PA 19134	Demolition Concrete/Civil	M-DBE
ABC Construction Company, Inc. Kimberly Nugent	714 Dunksferry Road #2 Bensalem, PA 19020	Demolition Concrete/Civil	W-DBE
Molly Construction Company Melinda De Nofa	1137 E. Venango Street Philadelphia, PA 19134	Demolition Concrete/Civil	W-DBE
Site Contractors, Inc. Theresa DiNatale	456 Highland Drive Mays Landing, NJ 08330	Demolition Concrete/Civil	W-DBE
C & M Contractors Michael Wooten	1816 W. Stiles Philadelphia, PA 19121	Demolition Concrete/Civil	M-DBE
Riddick & Riddick General Contractors Kim Riddick	945 E. Church Lane Philadelphia, PA 19138	Demolition Concrete/Civil	M-DBE
Building Restoration, Inc. Sidney H. Biddle	1025 Washington Lane Rydal, PA 19046	Civil/Concrete	W-DBE
Cornwells Construction Company, Inc.	1340 Cornwells Avenue	Civil/Concrete	W-DBE

FINAL VERSION

Helen Visone	Bensalem, PA 19020		
Verrazano Builders Frank Orman	3085 Mill Road, PO Box 932 Worcester, PA 19490	Concrete/Building	DS-DBE
Perryman Building & Construction Angelo Perryman	4548 Market Street Philadelphia, PA 19139	Concrete/Building	M-DBE
Wu & Associates, Inc. Raymond Wu	597 Deer Road Cherry Hill, NJ 08034	Concrete/Building	M-DBE
Cruz, Incorporated Luis Cruz	127 W. Susquehanna Ave Philadelphia, PA 19122	Civil/Exc/U.G. Utilities	M-DBE

13.8 Long-Term Operations. The Company's long-term operations subcontractor, Synagro, Inc., will meet with MBEC prior to start-up of the Class A Facility to review and submit its M/W/DSBE plan for the 20-year Biosolids Services. Synagro will utilize the services of Len Parker & Associates (LPA) to manage M/W/DSBE firms during the Long-Term Operations. LPA will provide transportation, maintenance and supply services required by the Company. LPA will solicit services from Philadelphia Certified M/W/DSBE firms from Table 6 and Table 7.

Table 6

Transportation

Alpha Waste Hauling
5 Blue Spruce Drive
Erial, NJ 08081
Dorian Evans
267-718-0031

Hank Beasley Trucking
8 Mark Anthony Circle
Morrisville, PA 19067
Hank Beasley
215-736-1251

Global Remediation Technology
1380 Barrowdale Road
Rydale, PA 19046
Robert Henderson
215-740-8039

J.K.T. Contractor and Development
242 South 51st Street
Philadelphia, PA 19139
Charles Hannah, Jr.
215-389-4664

Table 7

Janitorial/Maintenance Services

Disposal Corporation of America
3433 Moore Street
Philadelphia, PA 19145
Ellen Ryan
215-463-2528

Jacobs Contracting Services
320 W. Decatur Avenue
Pleasantville, NJ 08324
609-484-0064

Industrial Commercial Clean
64 Woodstone Drive
Voorhees, NJ 08043
Kim Epps-Jordan
856-627-1075

L'mours Professional
6304 N. 6th Street
Philadelphia, PA 19126
Jerry Wilson
215-549-7072

Team Clean Inc.
Naval Business Center, Bldg. 6
4900 S. Broad Street
Philadelphia, PA 19146
Donna Ali
267-514-8326

Additional categories being considered are uniform and other miscellaneous supply items.

Appendix 14

Class A Period Buy Out Schedule

14.1 Schedules

In the event of a Buy-Out of the Company-owned Operated Facilities by the PMA in accordance with Section 5.4 of the Service Agreement or a termination due to Uncontrollable Circumstances in Section 10.6 of the Service Agreement, the PMA shall pay Company:

(A) the then-current amount of outstanding Project Financing plus the Additional Capital and such other amounts in subsections (B), (C) and (E) as required in Sections 5.4 and 10.6.

(B) Schedule 1

<u>Contract Year of Buy Out</u> <u>Class A Period</u>	<u>Percentage of Fixed Operating and Variable Operating</u> <u>Costs for Prior Contract Year</u>
Year 11	50%
Year 12	45%
Year 13	40%
Year 14	35%
Year 15	30%
Year 16	25%
Year 17	20%
Year 18	15%
Year 19	10%
Year 20	0 %.

Such amounts shall be pro-rata for a portion of a Contract Year.

FINAL VERSION

(C) Schedule 2

Contract Year of Buy Out Percentage of Fixed Operating and Variable Operating
Costs for Prior Contract Year

Year 11	25.0 %
Year 12	22.5 %
Year 13	20.0 %
Year 14	17.5 %
Year 15	15.0 %
Year 16	12.5 %
Year 17	10.0 %
Year 18	7.5 %
Year 19	5.0%
Year 20	0 %.

Such amounts shall be pro-rata for a portion of a Contract Year.

(D) If PMA has not replaced Company and Company continues to operate the Operated Facilities Company shall not be entitled to additional compensation.

(E) If PMA has exercised its rights under Section 10.6 due to Uncontrollable Circumstances, Company shall be entitled to additional compensation for any Contract Year from Contract Year 1 through Contract Year 10 at 25% of the Fixed Operating Costs and Variable Operating Costs for the prior Contract Year, and for the Contract Years thereafter at the rates of additional compensation in Schedule 2.

Final

APPENDIX 15
City Contracts Assigned to Company

<u>Subcontractor</u>	<u>Contract Number</u>
Mobile Dredging and Pumping Co.	02-0737
Waste Management of PA, Inc.	03-0590
Synagro Mid-Atlantic, Inc.	05-0474
T.D.P.S. Materials	05-0154
Airmatic, Inc.	03-0602
Andritz Bird, Inc.	05-0383
Waste Management & Processors, Inc.	02-0539
Polydyne, Inc.	05-0140
Jesse Baro, Inc.	05-0064
General Asphalt Paving Company	04-0434
ECO Technology, Inc.	04-0026
Finn Scale Company	05-0455

SERVICE AGREEMENT

**PHILADELPHIA MUNICIPAL AUTHORITY
AND
PHILADELPHIA BIOSOLIDS SERVICES, LLC**

[AS PROVIDED IN EXHIBIT "B" TO THIS ORDINANCE]

SERVICE CONTRACT
TRANSACTION DOCUMENTS

- 1. City Lease Agreement (City Master Lease to PMA)**
[As provided herein in Exhibit "A"]
- 2. Lease Agreement (PMA Sublease to Company)**
[As provided herein in Exhibit "B"]
- 3. Company's Guaranty Form**
- 4. Performance Bond Form**
- 5. Payment Bond Form**

MASTER LEASE

**CITY OF PHILADELPHIA
&
PHILADELPHIA MUNICIPAL AUTHORITY**

[As included in Exhibit "A" to the Ordinance]

LEASE

**PHILADELPHIA MUNICIPAL AUTHORITY
&
PHILADELPHIA BIOSOLIDS SERVICES, LLC**

[As included in Exhibit "B" to the Ordinance]

FINAL VERSION

GUARANTY AGREEMENT

from

SYNAGRO TECHNOLOGIES, INC to

THE PHILADELPHIA MUNICIPAL AUTHORITY

[_____, 2006]

GUARANTY AGREEMENT

THIS GUARANTY AGREEMENT is made and dated as of [_____, 2006], between Synagro Technologies, Inc, a corporation organized and existing under the laws of Delaware (together with any permitted successors and assigns hereunder, the "Guarantor"), and The Philadelphia Municipal Authority ("PMA").

RECITALS

PMA and Philadelphia Biosolids Services, LLC ("PBS"), have entered into the Biosolids Recycling Center Operation Service Agreement dated [_____, 2006] for the operation, maintenance and initial capital improvements of PMA's biosolids recycling center facility located in Philadelphia, Pennsylvania (the "Facility") and the marketing of Product from the Facility, as amended from time to time (the "Service Agreement"); and

The Company is indirectly owned by the Guarantor; and

PMA will enter into the Service Agreement only if the Guarantor guarantees the performance by the Company of all of the Company's responsibilities and obligations under the Service Agreement as set forth in this guaranty agreement (the "Guaranty").

In order to induce the execution and delivery of the Service Agreement by PMA and in consideration thereof, the Guarantor agrees as follows:

ARTICLE 1 DEFINITIONS AND INTERPRETATION

1.1 **DEFINITIONS.** For the purposes of this Guaranty, the following words and terms shall have the respective meanings set forth as follows. Any capitalized word or term used but not defined herein is used as defined in the Service Agreement.

"Obligations" means the amounts payable to PMA by, and the covenants and agreements of, the Company pursuant to the terms of the Service Agreement.

"Transaction Agreement" means any agreement entered into by the Company or PMA in connection with the transactions contemplated by the Service Agreement.

1.2 **INTERPRETATION.** In this Guaranty, unless the context otherwise requires:

(A) **References Hereto.** The terms "hereby," "hereof," "herein," "hereunder" and any similar terms refer to this Guaranty, and the term "hereafter" means after, and the term "heretofore" means before, the date of execution and delivery of this Guaranty.

(B) **Gender and Plurality.** Words of the masculine gender mean and include correlative words of the feminine and neuter genders and words importing the singular number mean and include the plural number and vice versa.

FINAL VERSION

- (C) Persons. Words importing persons include firms, companies, associations, general partnerships, limited partnerships, trusts, business trusts, corporations and other legal entities, including public bodies, as well as individuals.
- (D) Headings. The table of contents and any headings preceding the text of the Articles, Sections and subsections of this Guaranty shall be solely for convenience of reference and shall not constitute a part of this Guaranty, nor shall they affect its meaning, construction or effect.
- (E) Entire Agreement. This Guaranty constitutes the entire agreement between the parties hereto with respect to the transactions contemplated by this Guaranty. Nothing in this Guaranty is intended to confer on any person other than the Guarantor, PMA and their permitted successors and assigns hereunder any rights or remedies under or by reason of this Guaranty.
- (F) Counterparts. This Guaranty may be executed in any number of original counterparts. All such counterparts shall constitute but one and the same Guaranty.
- (G) Applicable Law. This Guaranty shall be governed by and construed in accordance with the applicable laws of the Commonwealth of Pennsylvania, without giving effect to principles of Pennsylvania law concerning conflicts of law.
- (H) Severability. If any clause, provision, subsection, Section or Article of this Guaranty shall be ruled invalid by any court of competent jurisdiction, the invalidity of any such clause, provisions, subsection, Section or Article shall not affect any of the remaining provisions hereof, and this Guaranty shall be construed and enforced as if such invalid portion did not exist provided that such construction and enforcement shall not increase the Guarantor's liability beyond that expressly set forth herein.
- (I) Approvals. All approvals, consents and acceptances required to be given or made by any party hereto shall be at the sole discretion of the party whose approval, consent or acceptance is required.
- (J) Payments. All payments required to be made by the Guarantor hereunder shall be made in lawful money of the United States of America.

ARTICLE 2
REPRESENTATIONS AND WARRANTIES OF THE GUARANTOR

2.1 REPRESENTATIONS AND WARRANTIES OF THE GUARANTOR. The Guarantor hereby represents and warrants that:

- (A) Existence and Powers. The Guarantor is duly organized and validly existing as a corporation under the laws of Delaware, with full legal right, power and authority to enter into and perform its obligations under this Guaranty.
- (B) Due Authorization and Binding Obligation. The Guarantor has duly authorized the execution and delivery of this Guaranty, and this Guaranty has been duly executed and delivered by the Guarantor and constitutes the legal, valid and binding obligation of the Guarantor, enforceable against the Guarantor in accordance with its terms except insofar as such

enforcement may be affected by bankruptcy, insolvency, moratorium or by general equity principals of reorganization and other similar laws affecting creditors' rights generally.

(C) No Conflict. Neither the execution or delivery by the Guarantor of this Guaranty nor the performance by the Guarantor of its obligations hereunder (1) to the Guarantor's knowledge conflicts with, violates or results in a breach of any law or governmental regulation applicable to the Guarantor, or (2) conflicts with, violates or results in a material breach of any term or condition of the Guarantor's corporate charter or by-laws or any judgment, decree, agreement or instrument to which the Guarantor is a party or by which the Guarantor or any of its properties or assets are bound, or constitutes a default under any such judgment, decree, agreement or instrument, or (3) to the Guarantor's knowledge will result in the creation or imposition of any natural encumbrance of any nature whatsoever upon any of the properties or assets of the Guarantor except as permitted hereby or by any Transaction Agreement.

(D) No Governmental Approval Required. No approval, authorization, order or consent of, or declaration, registration or filing with, any governmental authority is required of the Guarantor for the valid execution and delivery by the Guarantor of this Guaranty, except such as shall have been duly obtained or made.

(E) No Litigation. There is no action, suit or other proceeding, at law or in equity, before or by any court or governmental authority, pending or, to the Guarantor's knowledge, threatened against the Guarantor which has a likelihood of an unfavorable decision, ruling or finding that would materially and adversely affect the validity or enforceability of this Guaranty.

(F) No Legal Prohibition. The Guarantor has no knowledge of any Applicable Law in effect on the date as of which this representation is being made which would prohibit the performance by the Guarantor of this Guaranty.

(G) Consent to Agreements. The Guarantor is fully aware of the terms and conditions of the Service Agreement.

(H) Consideration. This Guaranty is made in furtherance of the purposes for which the Guarantor has been organized, and the assumption by the Guarantor of its obligations hereunder will result in a material benefit to the Guarantor.

(I) Report of Financial Condition. Guarantor will make available to PMA, starting on the effective date of this Guaranty and thereafter within one hundred twenty (120) days after the end of each fiscal year of Guarantor, a copy of the annual audited financial statement of Guarantor, which statement shall be prepared in accordance with generally accepted accounting principles consistently applied and certified by a nationally recognized independent public accountant selected by Guarantor.

(J) Reasonable Assurances of Financial Condition. Upon PMA's request, Guarantor shall provide assurances to PMA that its financial condition has not materially diminished. Guarantor shall provide such commercially reasonable documentation as may be necessary to establish that its financial condition has not materially diminished.

**ARTICLE 3
GUARANTY COVENANTS**

3.1. GUARANTY TO PMA. The Guarantor hereby absolutely, presently, irrevocably and unconditionally guarantees to PMA for the benefit of PMA (1) the full and prompt payment when due of each and all of the payments required to be made by the Company to or for the account of PMA under the Service Agreement, when the same shall become due and payable pursuant to this Guaranty, and (2) the full and prompt performance and observance of each and all of the Obligations. Notwithstanding the unconditional nature of the Guarantor's obligations as set forth herein, the Guarantor shall have the right to assert the defenses provided in Section 3.4 hereof against claims made under this Guaranty.

3.2. RIGHT OF PMA TO PROCEED AGAINST GUARANTOR. This Guaranty shall constitute a guaranty of payment and of performance of the Obligations and not of collection, and the Guarantor specifically agrees that in the event of a failure by the Company to pay or perform any Obligation guaranteed hereunder, PMA shall have the right to proceed first and directly against the Guarantor under this Guaranty and without proceeding against the Company or exhausting any other remedies against the Company which PMA may have. Without limiting the foregoing, the Guarantor agrees that it shall not be necessary, and that the Guarantor shall not be entitled to require, as a condition of enforcing the liability of the Guarantor hereunder, that PMA (1) file suit or proceed to obtain a personal judgment against the Company or any other person that might be liable for any part of the Obligations, (2) make any other effort to obtain payment or performance of the Obligations from the Company other than providing the Company with any notice of such payment or performance as may be required by the terms of the Service Agreement or required to be given to the Company under Applicable Law, (3) foreclose against or seek to realize upon any security for the Obligations, or (4) exercise any other right or remedy to which PMA is or may be entitled in connection with the Obligations or any security therefor or any other guarantee thereof, except to the extent that any such exercise of such other right or remedy may be a condition to the Obligations of the Company or to the enforcement of remedies under the Service Agreement. Upon any unexcused failure by the Company in the payment or performance of any Obligation and the giving of such notice or demand, if any, to the Company and Guarantor as may be required in connection with such Obligation and this Guaranty, the liability of the Guarantor shall be effective and shall immediately be paid or performed. Notwithstanding PMA's right to proceed directly against the Guarantor, PMA (or any successor) shall not be entitled to more than a single full performance of the obligations in regard to any breach or non-performance thereof.

3.3. GUARANTY ABSOLUTE AND UNCONDITIONAL.

(A) The obligations of the Guarantor hereunder are absolute, present, irrevocable and unconditional and shall remain in full force and effect until the Company shall have fully discharged the Obligations in accordance with their respective terms, and except as provided in Section 3.4 hereof, shall not be subject to any counterclaim, set-off, deduction or defense (other than full and strict compliance with, or release, discharge or satisfaction of, such Obligations) based on any claim that the Guarantor may have against the Company, PMA or any other person. Without limiting the foregoing, the obligations of the Guarantor hereunder shall not be released,

FINAL VERSION

discharged or in any way modified by reason of any of the following (whether with or without notice to, knowledge by or further consent of the Guarantor):

- (1) the extension or renewal of this Guaranty or the Service Agreement up to the specified Terms of each agreement;
- (2) any exercise or failure, omission or delay by PMA in the exercise of any right, power or remedy conferred on PMA with respect to this Guaranty or the Service Agreement except to the extent such failure, omission or delay gives rise to an applicable statute of limitations defense with respect to a specific claim;
- (3) any permitted transfer or assignment of rights or obligations under the Service Agreement or under any other Transaction Agreement by any party thereto (other than a permitted assignment to a replacement constructor or operator in the event of a termination of the Company pursuant to the Service Agreement), or any permitted assignment, conveyance or other transfer of any of their respective interests in the Facility under any of the Transaction Agreements;
- (4) any permitted assignment for the purpose of creating a security interest or mortgage of all or any part of the respective interests of PMA or any other person in any Transaction Agreement or in the Facility;
- (5) any renewal, amendment, change or modification in respect of any of the Obligations or terms or conditions of any Transaction Agreements;
- (6) any failure of title with respect to all or any part of the respective interests of any person in the BRC Site or the Facility;
- (7) except as permitted by Sections 4.1 or 4.2 hereof, any sale or other transfer by the Guarantor or any affiliate of any of the capital stock or other interest of the Guarantor or any affiliate in the Company now or hereafter owned, directly or indirectly, by the Guarantor or any affiliate, or any change in composition of the interests in the Company;
- (8) any failure on the part of the Company for any reason to perform or comply with any agreement with the Guarantor;
- (9) the failure on the part of PMA to provide any notice to the Guarantor which is not required to be given to the Guarantor pursuant to this Guaranty and to the Company as a condition to the enforcement of Obligations pursuant to the Service Agreement;
- (10) any failure of any party to the Transaction Agreements to mitigate damages resulting from any default by the Company or the Guarantor under any Transaction Agreement;

- (11) the merger or consolidation of any party to the Transaction Agreements into or with any other person, or any sale, lease, transfer, abandonment or other disposition of any or all of the property of any of the foregoing to any person;
 - (12) any legal disability or incapacity of any party to the Transaction Agreements; or
 - (13) the fact that entering into any Transaction Agreement by the Company or the Guarantor was invalid or in excess of the powers of such party.
- (B) Should any money due or owing to PMA under this Guaranty not be recoverable from the Company due to any of the matters specified in subparagraphs (1) through (14) above, then, in any such case, such money, together with all additional sums due hereunder, shall nevertheless be recoverable from the Guarantor as though the Guarantor were principal obligor in place of the Company pursuant to the terms of the Service Agreement and not merely a guarantor and shall be paid by the Guarantor forthwith subject to the terms of this Guaranty. Notwithstanding anything to the contrary expressed in this Guaranty, nothing in this Guaranty shall be deemed to amend, modify, clarify, expand or reduce the Company's rights, benefits, duties or obligations under the Service Agreement. To the extent that any of the matters specified in subparagraphs (1) through (13) would provide a defense to, release, discharge or otherwise affect the Company's Obligations, the Guarantor's obligations under this Guaranty shall be treated the same.

3.4. DEFENSES, SET-OFFS AND COUNTERCLAIMS. Notwithstanding any provision contained herein to the contrary, the Guarantor shall be entitled to exercise or assert any and all legal or equitable rights or defenses which the Company may have under the Service Agreement or under Applicable Law (other than bankruptcy or insolvency of the Company and other than any defense which the Company has expressly waived in the Service Agreement), and the obligations of the Guarantor hereunder are subject to such counterclaims, set-offs or deductions which the Company is permitted to assert pursuant to the Service Agreement if any.

3.5. WAIVERS BY THE GUARANTOR.

- (A) The Guarantor hereby unconditionally and irrevocably waives:
- (1) notice from PMA of its acceptance of this Guaranty;
 - (2) notice of any of the events referred to in Section 3.3 hereof except to the extent that notice is required to be given as a condition to the enforcement of Obligations;
 - (3) to the fullest extent lawfully possible, all notices which may be required by statute, rule of law or otherwise to preserve intact any rights against the Guarantor, except any notice to the Company required pursuant to the Service Agreement or Applicable Law as a condition to the performance of any Obligation;
 - (4) to the fullest extent lawfully possible, any statute of limitations defense based on a statute of limitations period which may be applicable to guarantors (or parties in similar

relationships) which would be shorter than the applicable statute of limitations period for the underlying claim;

- (5) any right to require a proceeding first against the Company;
- (6) any right to require a proceeding first against any person or the security provided by or under any Transaction Agreement except to the extent such Transaction Agreement specifically requires a proceeding first against any person (except the Company) or security;
- (7) any requirement that the Company be joined as a party to any proceeding for the enforcement of any term of any Transaction Agreement;
- (8) the requirement of, or the notice of, the filing of claims by PMA in the event of the receivership or bankruptcy of the Company; and
- (9) all demands upon the Company or any other person and all other formalities the omission of any of which, or delay in performance of which, might, but for the provisions of this Section 3.5, by rule of law or otherwise, constitute grounds for relieving or discharging the Guarantor in whole or in part from its absolute, present, irrevocable, unconditional and continuing obligations hereunder.

3.6 PAYMENT OF COSTS AND EXPENSES. The Guarantor agrees to pay PMA on demand all reasonable costs and expenses, legal or otherwise (including counsel fees), directly incurred by or on behalf of PMA in successfully enforcing by Legal Proceeding observance of the covenants, agreements and obligations contained in this Guaranty against the Guarantor, other than the costs and expenses that PMA incurs in performing any of its obligations under the Service Agreement, or other applicable Transaction Agreement where such obligations are a condition to performance by the Company of its Obligations.

3.7. SUBORDINATION OF RIGHTS. The Guarantor agrees that any right of subrogation or contribution which it may have against the Company as a result of any payment or performance hereunder is hereby fully subordinated to the rights of PMA hereunder and under the Transaction Agreements and that the Guarantor shall not recover or seek to recover any payment made by it hereunder from the Company until the Company and the Guarantor shall have fully and satisfactorily paid or performed and discharged the Obligations giving rise to a claim under this Guaranty.

3.8. SEPARATE OBLIGATIONS; REINSTATEMENT. The obligations of the Guarantor to make any payment or to perform and discharge any other duties, agreements, covenants, undertakings or obligations hereunder shall (1) to the extent permitted by Applicable Law, constitute separate and independent obligations of the Guarantor from its other obligations under this Guaranty, (2) give rise to separate and independent causes of action against the Guarantor and (3) apply irrespective of any indulgence granted from time to time by PMA. The Guarantor agrees that this Guaranty shall be automatically reinstated if and to the extent that for any reason any payment by or on behalf of the Company is rescinded or must be otherwise restored by

FINAL VERSION

PMA, whether as a result of any proceedings in bankruptcy, reorganization or similar proceeding, unless such rescission or restoration is pursuant to the terms of the Service Agreement, or any applicable Transaction Agreement or the Company's enforcement of such terms under Applicable Law.

3.9. TERM. This Guaranty shall remain in full force and effect from the date of execution and delivery hereof until all of the Obligations of the Company have been fully paid and performed.

3.10. MAXIMUM GUARANTEE OBLIGATION. The Guarantor's maximum obligation under this Guaranty shall be limited in amount to the Company's Service Fee for the then-current Contract Year as defined in the Service Agreement.

**ARTICLE 4
GENERAL COVENANTS**

4.1. MAINTENANCE OF CORPORATE EXISTENCE.

(A) Consolidation, Merger, Sale or Transfer. Consolidation, Merger, Sale or Transfer. The Guarantor covenants that during the term of this Guaranty it will maintain its corporate existence, will not dissolve or otherwise dispose of all or substantially all of its assets and will not consolidate with or merge into another entity or permit one or more other entities to consolidate with or merge into it unless the successor is the Guarantor and the conditions contained in clause (2) below are satisfied; provided, however, that the Guarantor may consolidate with or merge into another entity, or permit one or more other entities to consolidate with or merge into it, or sell or otherwise transfer to another entity all or substantially all of its assets as an entirety and thereafter dissolve if (1) the successor entity (if other than the Guarantor) (a) assumes in writing all the obligations of the Guarantor hereunder and, if required by law, is duly qualified to do business in the Commonwealth of Pennsylvania, and (b) delivers to PMA and opinion of counsel to the effect that its obligations under this Guaranty are legal, valid, binding and enforceable subject to applicable bankruptcy and similar insolvency or moratorium laws, and (2) any such transaction does not result in a change, financial or otherwise, in the condition of the Guarantor that would materially and adversely affect the ability of the Guarantor to perform its obligations under the Service Agreement and the Guaranty.

(B) Continuance of Obligations. If a consolidation, merger or sale or other transfer is made as permitted by this Section 4.1, the provisions of this Section 4.1 shall continue in full force and effect and no further consolidation, merger or sale or other transfer shall be made except in compliance with the provisions of this Section 4.1. No such consolidation, merger or sale or other transfer shall have the effect of releasing the initial Guarantor from its liability hereunder unless a successor entity has assumed responsibility for this Guaranty as provided in this Section.

4.2. ASSIGNMENT. Without the prior written consent of PMA, this Guaranty may not be assigned by the Guarantor, except pursuant to Section 4.1 hereof.

FINAL VERSION

- 4.3. CONSENT TO JURISDICTION. The Guarantor irrevocably: (1) agrees that any suit, action or other legal proceeding arising out of this Guaranty shall be brought in the courts of the Commonwealth of Pennsylvania; (2) consents to the jurisdiction of such court in any such suit, action or proceeding; (3) waives any objection which it may have to the laying of the jurisdiction of any such suit, action or proceeding in any of such courts; and (4) waives its right to a trial by jury in any suit, action or proceeding in any of such courts.
- 4.4. BINDING EFFECT. This Guaranty shall inure to the benefit of PMA and its permitted successors and assigns and shall be binding upon the Guarantor and its successors and assigns.
- 4.5. AMENDMENTS, CHANGES AND MODIFICATIONS. This Guaranty may not be amended, changed or modified or terminated and none of its provisions may be waived, except with the prior written consent of PMA and of the Guarantor.
- 4.6. LIABILITY. It is understood and agreed to by PMA that nothing contained herein shall create any obligation of or right to look to any director, officer, employee or stockholder of the Guarantor (or any affiliate thereof) for the satisfaction of any obligations hereunder, and no judgment, order or execution with respect to or in connection with this Guaranty shall be taken against any such director, officer, employee or stockholder.
- 4.7. NOTICES. Any notices or communications required or permitted hereunder shall be in writing and shall be sufficiently given if faxed (with acknowledgment of receipt and followed by mailing of hardcopy), delivered in person, or sent by overnight courier to the following addresses, or to such other addresses as any of the recipients may from time to time designate by notice given in writing.

If to the Guarantor:
Synagro Technologies, Inc.
1800 Bering Drive, Suite 1000
Houston, TX 77057
Attn: General Counsel
713-369-1700
713-369-1750 fax

If to PMA:
Executive Director
The Philadelphia Municipal Authority
1515 Arch Street
9th Floor
Philadelphia, Pennsylvania 19102

FINAL VERSION

IN WITNESS WHEREOF, the Guarantor has caused this Guaranty to be executed in its name and on its behalf by its duly authorized officer as of the date first above written.

[Synagro Technologies, Inc.]

As Guarantor

By: _____
Printed Name:
Title:

SEAL
[IMPRESSED ON EXECUTION COPIES]

Accepted and Agreed to by:

THE PHILADELPHIA MUNICIPAL
AUTHORITY

By: _____
Printed Name:
Title:

TABLE OF CONTENTS

	<u>Page</u>
ARTICLE I DEFINITIONS AND INTERPRETATION.....	1
SECTION 1.1 DEFINITIONS.....	1
SECTION 1.2. INTERPRETATION.....	1
ARTICLE II REPRESENTATIONS AND WARRANTIES OF THE GUARANTOR.....	2
SECTION 2.1 REPRESENTATIONS AND WARRANTIES OF THE GUARANTOR	2
ARTICLE III GUARANTY COVENANTS.....	4
SECTION 3.1. GUARANTY TO PMA	4
SECTION 3.2. RIGHT OF PMA TO PROCEED AGAINST GUARANTOR.....	4
SECTION 3.3. GUARANTY ABSOLUTE AND UNCONDITIONAL.....	4
SECTION 3.4. DEFENSES, SET-OFFS AND COUNTERCLAIMS.....	6
SECTION 3.5. WAIVERS BY THE GUARANTOR	6
SECTION 3.6 PAYMENT OF COSTS AND EXPENSES	7
SECTION 3.7. SUBORDINATION OF RIGHTS	7
SECTION 3.8. SEPARATE OBLIGATIONS; REINSTATEMENT.....	7
SECTION 3.9. TERM	8
SECTION 3.10. MAXIMUM GUARANTEE OBLIGATION	8
ARTICLE IV GENERAL COVENANTS.....	8
SECTION 4.1. MAINTENANCE OF CORPORATE EXISTENCE	8
SECTION 4.2. ASSIGNMENT.....	8
SECTION 4.3. CONSENT TO JURISDICTION.....	9
SECTION 4.4. BINDING EFFECT	9
SECTION 4.5. AMENDMENTS, CHANGES AND MODIFICATIONS.....	9
SECTION 4.6. LIABILITY.....	9
SECTION 4.7. NOTICES.....	9



CITY OF PHILADELPHIA

PERFORMANCE BOND

Bid No. _____

Bond No. _____

City Contract No. _____

Bond Amount _____

1. Contractor Name and the Surety _____ jointly and severally, bind themselves, their heirs, executors, administrators, successors, and assigns to the City for the performance of the City Contract, the PROJECT DESCRIPTION for the DEPARTMENT NAME Department which is incorporated herein by reference.
2. If the Contractor performs the City Contract, in accordance with the terms and conditions of the City Contract, the Surety and the Contractor shall have no further obligation under this Performance Bond.
3. The Surety's obligation under this Performance Bond shall arise after the City has declared a Contractor Default as defined below, formally terminated the City Contract or the Contractor's right to complete the City Contract, and notified the Surety of the City's claim under this Performance Bond.
4. When the City has satisfied the conditions of Paragraph 3 above, the Surety shall, at the Surety's sole cost and expense, undertake one or more of the following actions:
 - a. Arrange for the Contractor to perform and complete the City Contract, provided, however, that the Surety may not proceed with this option, except upon the express written consent of the City, which consent may be withheld by the City for any reason; or
 - b. Perform and complete the City Contract itself, through qualified contractors who are acceptable to the City, through a contract between the Surety and qualified contractors, which performance and completion shall be undertaken in strict accordance with the terms and conditions of the City Contract; or
 - c. Tender payment to the City in the amount of all losses incurred by the City as a result of the Contractor Default and as determined by the City for which the Surety is liable to the City, including all costs of completion of the City Contract and all consequential losses, costs, and expenses incurred by the City as a result of the Contractor Default, and including all unpaid fees or payments owed to the City by the Contractor under the City Contract, except that Surety's payment under this option shall in no event exceed the limit of the Bond Amount. The Surety may not proceed with this option, in lieu of the options set forth in subparagraphs (a) or (b) above, except upon the express written consent of the City, which consent may be withheld by the City for any reason.
5. The Surety shall proceed under Paragraph 4 above within ten (10) business days after notice from the City to the Surety of the Contractor Default, formal termination of the Contract or the Contractor's right to complete the City Contract, except that the Surety shall proceed within twenty-four (24) hours after notice, where the notice states that immediate action by the Surety is necessary to safeguard life or property.
6. If the Surety fails to proceed in accordance with Paragraphs 4 and 5 above, then the Surety shall be deemed to be in default on this Performance Bond three business days after receipt of written notice from the City to the Surety demanding that the Surety perform its obligations under this Performance Bond. Thereafter, if notice to the Surety is without effect, the City shall be entitled to enforce any legal or equitable remedy available to the City. If the Surety has denied liability, in whole or in part, the City shall be entitled without further notice to Surety to enforce any legal or equitable remedies available to the City.
7. After the City has terminated the City Contract or the Contractor's right to complete the City Contract, and if the Surety is proceeding under subparagraphs 4(a) or 4(b) above, then the responsibilities of the Surety to the

City shall not be greater than those of the Contractor under the City Contract, and the responsibilities of the City to the Surety shall not be greater than those of the City under the City Contract. The Surety shall be obligated to the limit of Bond Amount as set forth on the front page, subject, however, to a commitment by the City for payment to the Surety of the Balance of the Contract Price in mitigation of costs and damages on the City Contract. The Surety shall be obligated, without duplication, for:

- a. The responsibilities of the Contractor for correction of defective or unsuitable work and performance and completion of the City Contract;
 - b. Additional legal, design professional, and delay costs incurred by the City as a result of the Contractor's Default, and as a result of the Surety's actions or failures to act under Paragraph 4 above;
 - c. Liquidated damages as specified in the City Contract, or, if no liquidated damages are specified in the City Contract, actual damages and consequential damages incurred by the City as a result of delayed performance or non-performance of City Contract by the Contractor or the Surety; and
 - d. Payment of all unpaid and due and owing fees or payments owed to the City under the City Contract at the time of the Contractor Default.
8. To the extent of payment to the Surety of the Balance of the Contract Price, the Surety shall defend, indemnify, and hold harmless the City from all claims, suits, causes of actions, and demands (including all costs of litigation and a reasonable attorney's fee), which are brought against the City by the Contractor or any other party and which arise from or by reason of payment to the Surety the Balance of the Contract Price.
9. The Surety hereby waives notice of any change or modification to the City Contract, including changes of time, or changes to related subcontracts, purchase orders, and other obligations.
10. Any proceeding, suit, or claim, legal or equitable, under this Performance Bond shall be instituted in the U.S. District Court for the Eastern District of Pennsylvania or the Court of Common Pleas of Philadelphia County and shall be instituted within two years of the date on which the Surety refuses or fails to perform its obligations under this Performance Bond, in accordance with Paragraphs 4 and 5 above. If the provisions of this Paragraph are void or prohibited by law, the minimum limitations period available to sureties as a defense in the jurisdiction of the proceeding, suit, or claim shall be applicable.
11. All notices to the Surety or the Contractor shall be mailed or delivered to the respective addresses shown on the signature page. In the event of a change in the address of the Surety or the Contractor, such party shall promptly provide notice to the City and the other party, with such notice to include the City Contract No. and this Performance Bond No.
12. When this Performance Bond has been furnished to the City in compliance with the Public Works Contractors' Bond Law of 1967, 8 P.S. § 191, *et seq.*, any provision in this Performance Bond which conflicts with the statutory or legal requirement of such statute shall be deemed deleted herefrom and provisions conforming to such statutory or other legal requirement shall be deemed incorporated herein.
13. The law controlling the interpretation or enforcement of this Performance Bond shall be Pennsylvania law.
14. Definitions
- a. Balance of the Contract Price: The total amount payable by the City to the Contractor under the City Contract after all proper adjustments have been made, including change orders and credits due the City, reduced by all valid and proper payments made to or on behalf of the Contractor under the City Contract and reduced further by all direct costs and expenses incurred by the City as a result of the Contractor Default, including costs of additional supervision or inspection by the City of the Contractor's work under the City Contract and fees and expenses paid to consultants or others hired by the City for purposes of monitoring or investigating the Contractor's work under the City Contract.
 - b. City Contract: The agreement between the City and the Contractor identified on the front page.

c. Contractor Default: In the case of City Contracts for Public Works, "Contractor Default" shall mean the failure or refusal of the Contractor, after written notice from the City, to cure or remedy, or commence to cure or remedy, a Violation of City Contract (as defined in the City's Standard Contract Requirements for Public Works Contracts) within three (3) working days from receipt of such notice, or within twenty-four (24) hours from receipt of such notice, where immediate action by the Contractor is necessary to safeguard life or property. In the case of all other City Contracts, "Contractor Default" shall mean the occurrence of an "event of default" or a "termination for cause" as defined or provided for in the City Contract's terms, conditions, and provisions.

CONTRACTOR AS PRINCIPAL:

Signature: _____
Title: _____
Date: _____
Address: _____

(Corporate Seal)

SURETY:

Signature: _____
Attorney-In-Fact
(*Attach Power of Attorney)
Date: _____
Address: _____

(Surety Seal)



CITY OF PHILADELPHIA

PAYMENT BOND

Bid No. _____

Bond No. _____

City Contract No. _____

Bond Amount _____

1. Contractor Name and Surety _____, jointly and severally, bind themselves, their heirs, executors, administrators successors and assigns to the City to pay for labor, materials, and equipment furnished for use in the performance of the City Contract, the Project Description for the Department Name Department, which is incorporated herein by reference.
2. With respect to the City, this obligation shall be null and void if the Contractor:
 - a. Promptly makes payment, directly or indirectly, for all sums due Claimants; and
 - b. Defends, indemnifies, and holds harmless the City from any claims, demands, liens, or suits by any person or entity whose claim, demand, lien, or suit is for the payment for labor, materials, or equipment furnished for use in the performance of the City Contract, provided the City has promptly notified the Contractor and the Surety (at the addresses described in Paragraph 10) of any such claims, demands, liens or suits and has tendered defense of such claims, demands, liens, or suits to the Contractor and the Surety.
3. With respect to Claimants, this obligation shall be null and void if the Contractor promptly makes payment, directly or indirectly, for all sums due.
4. In the event that the Contractor shall not make prompt payment to Claimants, the Surety's obligation to Claimants under this Payment Bond, and a Claimant's rights under this Payment Bond, shall be governed solely by the Public Works Contractors' Bond Law of 1967, 8 P.S. § 191, et seq.
5. Amounts owed by the City to the Contractor under the City Contract shall be used for the performance of the City Contract and to satisfy claims, if any, under any Performance Bond. By the Contractor furnishing and the City accepting this Payment Bond, they agree that all funds earned by the Contractor in the performance of the City Contract are dedicated to satisfy obligations of the Contractor and the Surety under this Payment Bond, subject, however, to the City's priority to use the funds for the completion of the work under the City Contract.
6. The Surety shall not be liable to the City, Claimants, or others for obligations of the Contractor that are unrelated to the City Contract. The City shall not be liable for payment of any costs or expenses of any Claimant under this Payment Bond, and the City shall have under this Payment Bond no obligations to make payments to, give notices on behalf of, or otherwise have obligations to Claimants under this Payment Bond.
7. The Surety hereby waives notice of any change or modification to the City Contract, including changes of time, or changes to related subcontracts, purchase orders, and other obligations.
8. Any suit or action under this Payment Bond shall be commenced by a Claimant in accordance with the Public Works Contractors' Bond Law of 1967, 8 P.S. § 191, et seq., or any other applicable law.
9. All notices to the Surety or the Contractor shall be mailed or delivered to the respective addresses shown on the signature page. In the event of a change in the address of the Surety or the Contractor, such party shall promptly provide notice to the City and the other party, with such notice to include the City Contract No. and this Performance Bond No.
10. When this Payment Bond has been furnished to the City in compliance with the Public Works Contractors' Bond Law of 1967, 8 P.S. § 191, et seq., any provision in this Payment Bond which conflicts with the statutory or legal requirement of such statute shall be deemed deleted herefrom and provisions conforming to such statutory or other legal requirement shall be deemed incorporated herein.

11. Upon request by any person or entity appearing to be a potential beneficiary of this Payment Bond, the Contractor shall promptly furnish a copy of this Payment Bond or shall permit a copy to be made.
12. The law controlling the interpretation or enforcement of this Payment Bond shall be Pennsylvania law.

13. Definitions

- a. Claimant: An individual or entity having a direct contract with the Contractor or with a subcontractor of the Contractor to furnish labor, materials, or equipment for use in the performance of the City Contract.
- b. City Contract: The agreement between the City and the Contractor identified on the front page, which shall encompass all Contract Documents, including the Bid, Bid Addenda, and Amendments to the City Contract, and any changes thereto.
- c. Labor, materials, or equipment: All labor supplied or performed, all materials furnished, all equipment or machinery rented, and all services rendered by public utilities in the performance of the work under the City Contract, whether or not such labor, material, equipment, machinery, or public utility services enter into and become component parts of the work or improvement contemplated by the City Contract, including, inter alia: (a) all material furnished, equipment or machinery rented, services rendered by public utilities, and labor supplied or performed in preparing the work site for the performance of the work covered by the City Contract; (b) all equipment, machinery, public utility services, labor, shoring, sheathing and blasting supplies, and other materials used on the work site in doing such excavating as may be necessary or required to institute or perform the work specified in the City Contract; (c) all water, gas, power, light, heat, oil, gasoline, telephone service, or rental equipment used in the City Contract, architectural and engineering services required for performance of the work of the Contractor and the Contractor's subcontractors; and (d) all material furnished, equipment or machinery rented, services rendered by public utilities, and labor supplied or performed in the performance of work or of maintenance required by or performed under the terms of the City Contract.

CONTRACTOR AS PRINCIPAL:

SURETY:

Signature: _____

Signature: _____

Title: _____

Attorney-In-Fact
(*Attach Power of Attorney)

Date: _____

Date: _____

Address: _____

Address: _____

(Corporate Seal)

(Surety Seal)